

Direvisi Oleh	Revisi	Disetujui Oleh	Tgl.Efektif
	△		
	△		
	△		

1. Pemasangan Sticker Safety Notice dan Safety Label Head Board

SAFETY NOTICE



Posisi Pemasangan :
DI Head Board,Rata tengah dan 10 mm
dari bagian atas Wood Pattern Head
Board
Pasang safety Notice terlebih dahulu,
kemudian safety Label (jarak 10mm)

Pastikan :
Pemasangan Rata / tidak miring
Sticker merekat dengan sempurna



CB-XXXX D DX

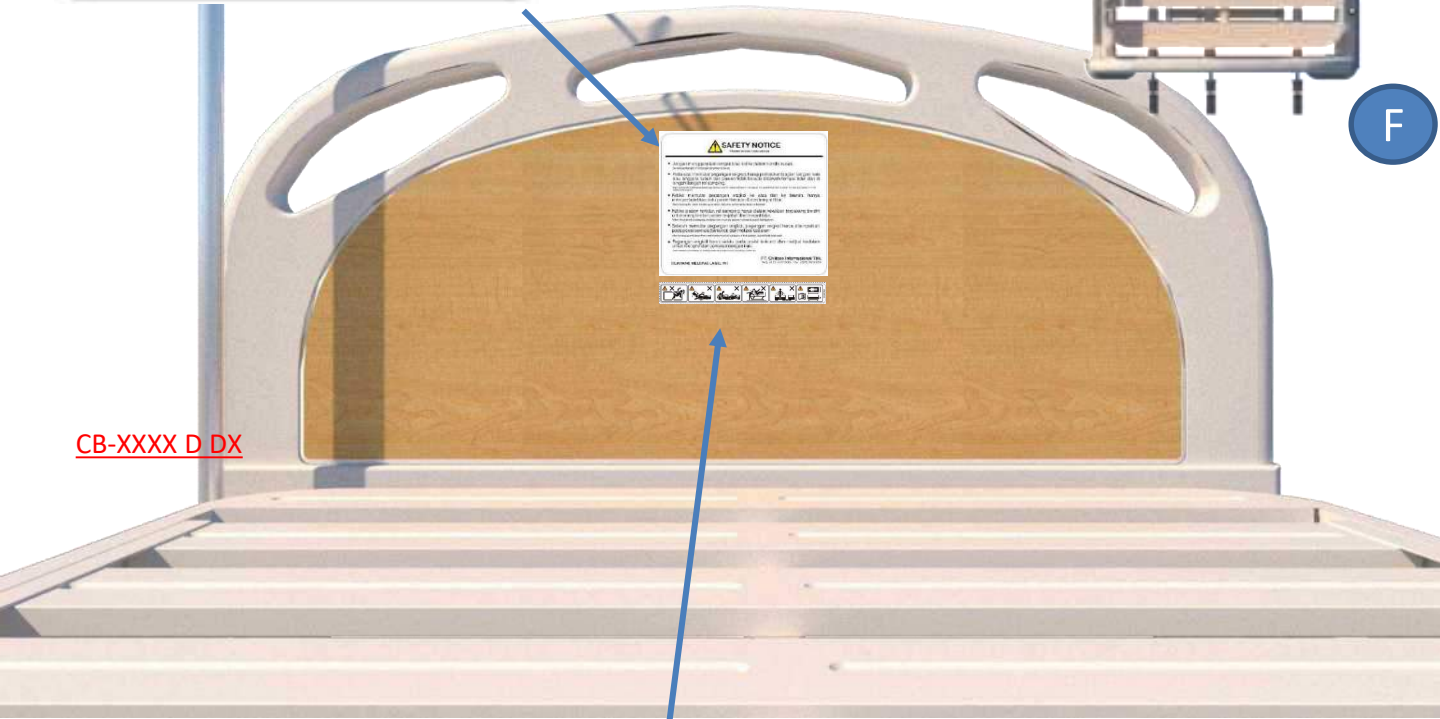

SAFETY LABEL



CB-XXXX D ST

CB-XXXX D JP

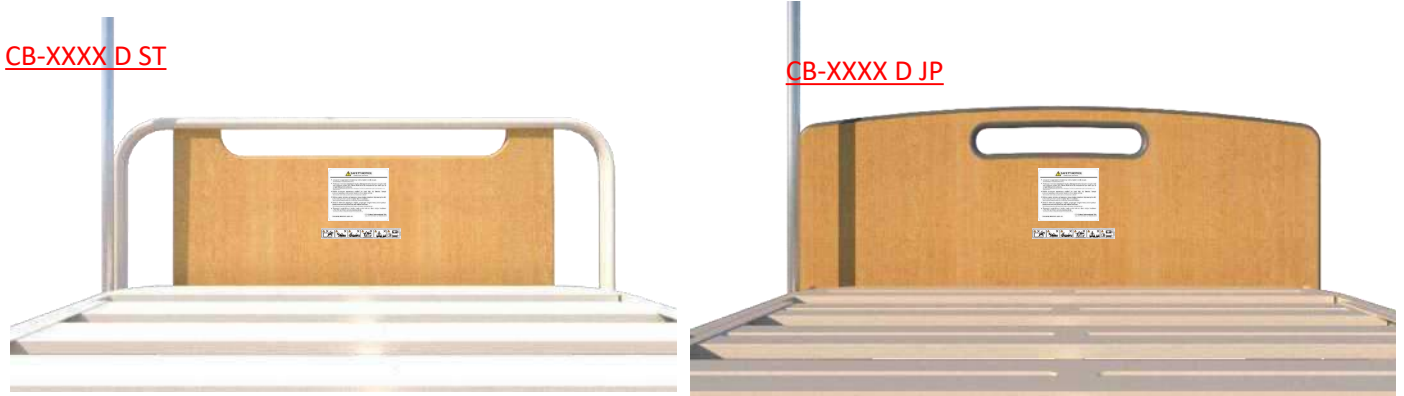

Direvisi Oleh	Revisi	Disetujui Oleh	Tgl.Efektif
	△		
	△		
	△		

1. Pemasangan Sticker Safety Notice dan Safety Label pada Foot Board

SAFETY NOTICE



Posisi Pemasangan :
DI Foot Board, Rata tengah dan 10 mm
dari bagian bawah Wood Pattern Foot Board
Pasang safety label terlebih dahulu,
kemudian safety notice

Pastikan :
Pemasangan Rata / tidak miring
Sticker merekat dengan sempurna

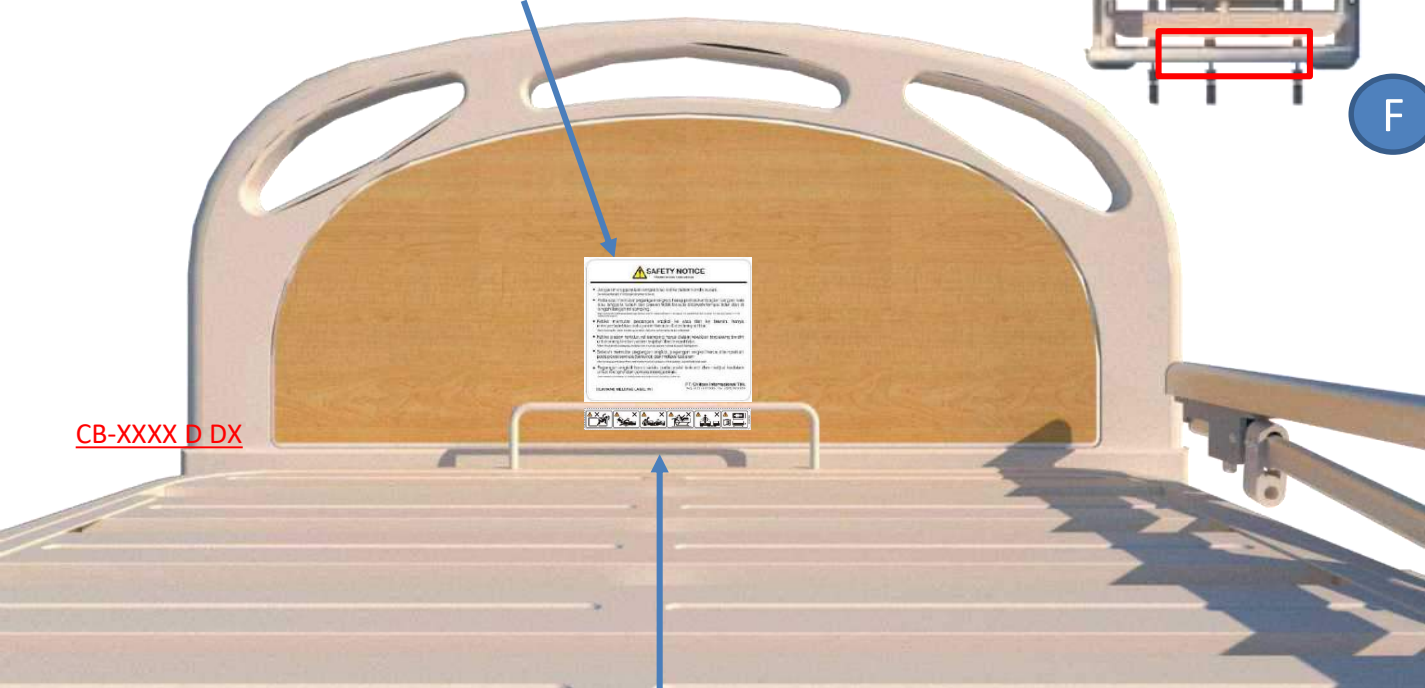
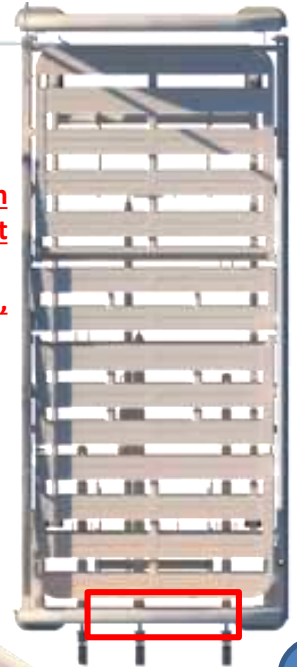

SAFETY LABEL

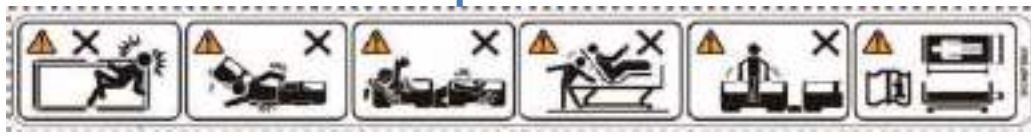

CB-XXXX D ST

CB-XXXX D JP

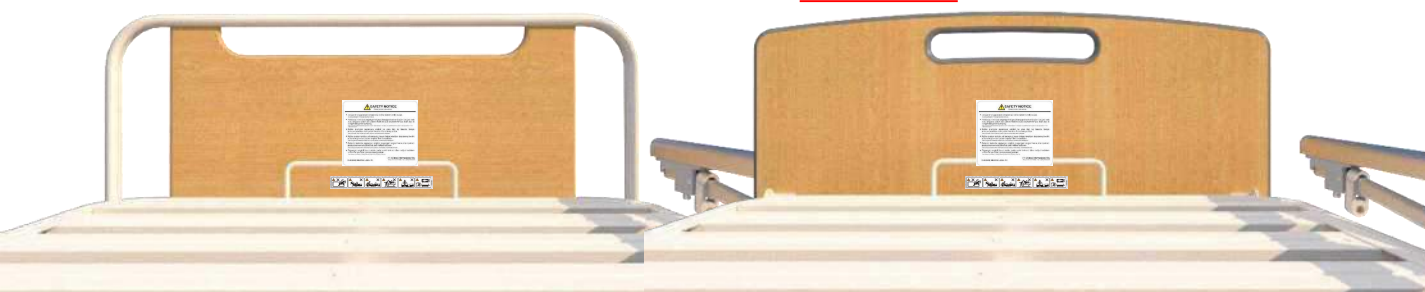

Direvisi Oleh	Revisi	Disetujui Oleh	Tgl.Efektif
	△		
	△		
	△		

2. Pemasangan Sticker Lot Number, Logo, Caution dan SNI

CAUTION LABEL



LABEL SNI



LOGO



CRANK LABEL



IZIN EDAR KEMENKES



CRANK LABEL

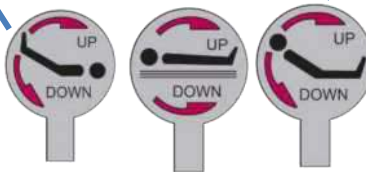

LOT NUMBER TIPE MANUAL

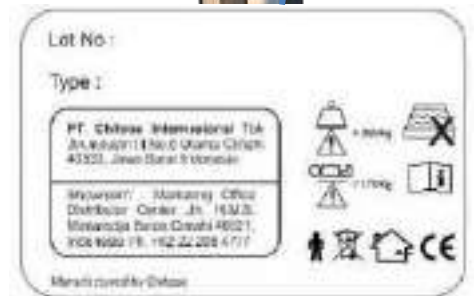

**Posisi Pemasangan ;
 Main Frame di area Foot Board**

**Pastikan :
 Pemasangan Rata / tidak miring
 Sticker melekat dengan sempurna
 Label SNI memakai ukuran besar**

Direvisi Oleh	Revisi	Disetujui Oleh	Tgl.Efektif
	△		
	△		
	△		

2. Pemasangan Sticker Lot Number, Logo, Caution dan SNI

CAUTION LABEL



LABEL SNI



LOGO



CRANK LABEL

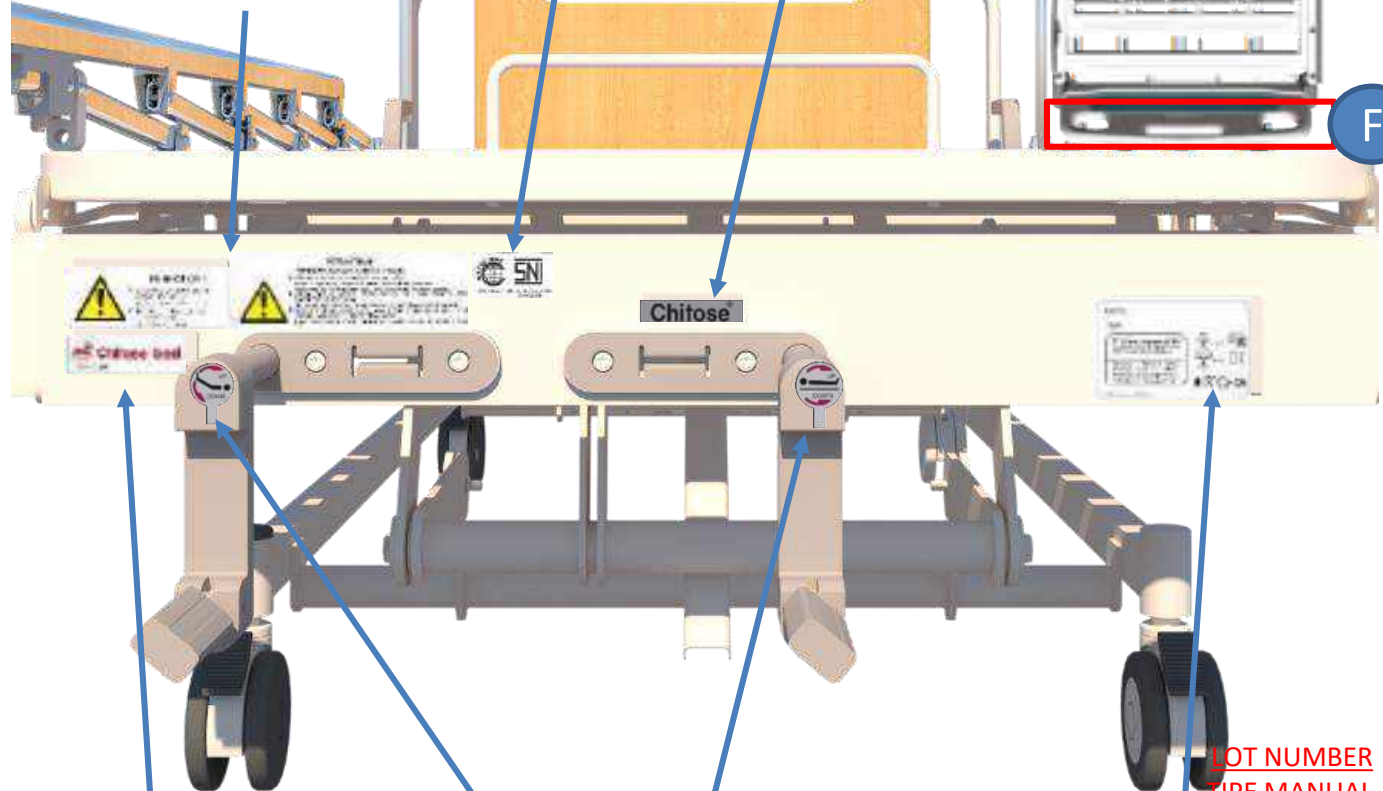

IZIN EDAR KEMENKES



CRANK LABEL



LOT NUMBER TYPE MANUAL

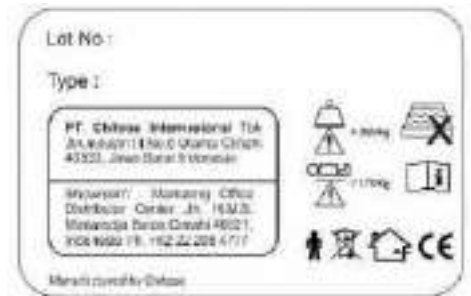

**Posisi Pemasangan ;
 Main Frame di area Foot Board**

**Pastikan :
 Pemasangan Rata / tidak miring
 Sticker melekat dengan sempurna
 Label SNI memakai ukuran besar**

Direvisi Oleh	Revisi	Disetujui Oleh	Tgl.Efektif
	△		
	△		
	△		

2. Pemasangan Sticker Lot Number, Logo, Caution dan SNI

CAUTION LABEL



LABEL SNI



LOGO



CRANK LABEL

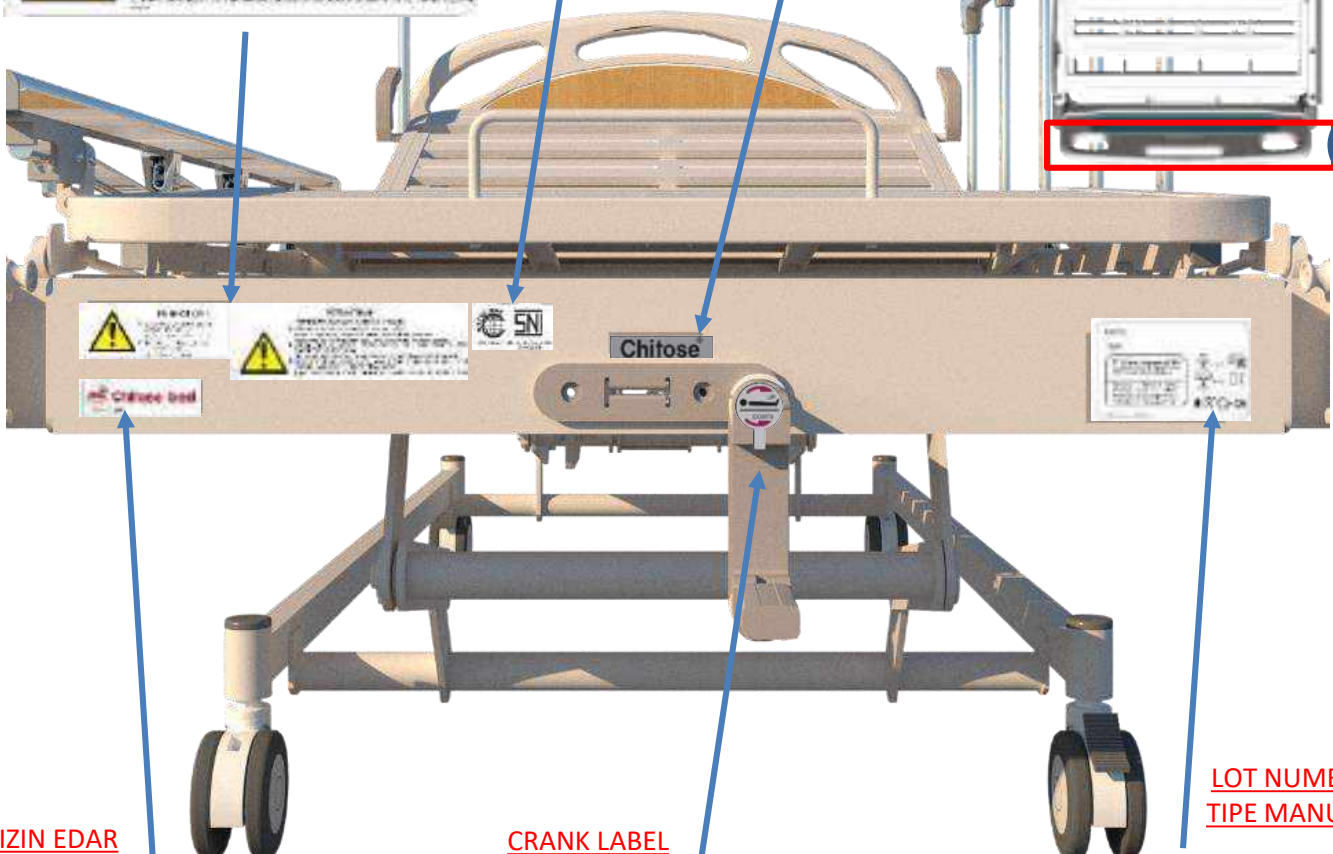

IZIN EDAR KEMENKES



CRANK LABEL



LOT NUMBER TIPE MANUAL

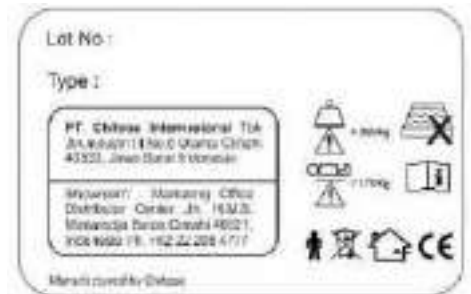

**Posisi Pemasangan ;
 Main Frame di area Foot Board**

**Pastikan :
 Pemasangan Rata / tidak miring
 Sticker melekat dengan sempurna
 Label SNI memakai ukuran besar**

Direvisi Oleh	Revisi	Disetujui Oleh	Tgl.Efektif
	△		
	△		
	△		

2. Pemasangan Sticker Lot Number, Logo, Caution dan SNI

CAUTION LABEL



VOLTAGE LABEL



LABEL SNI



LOGO

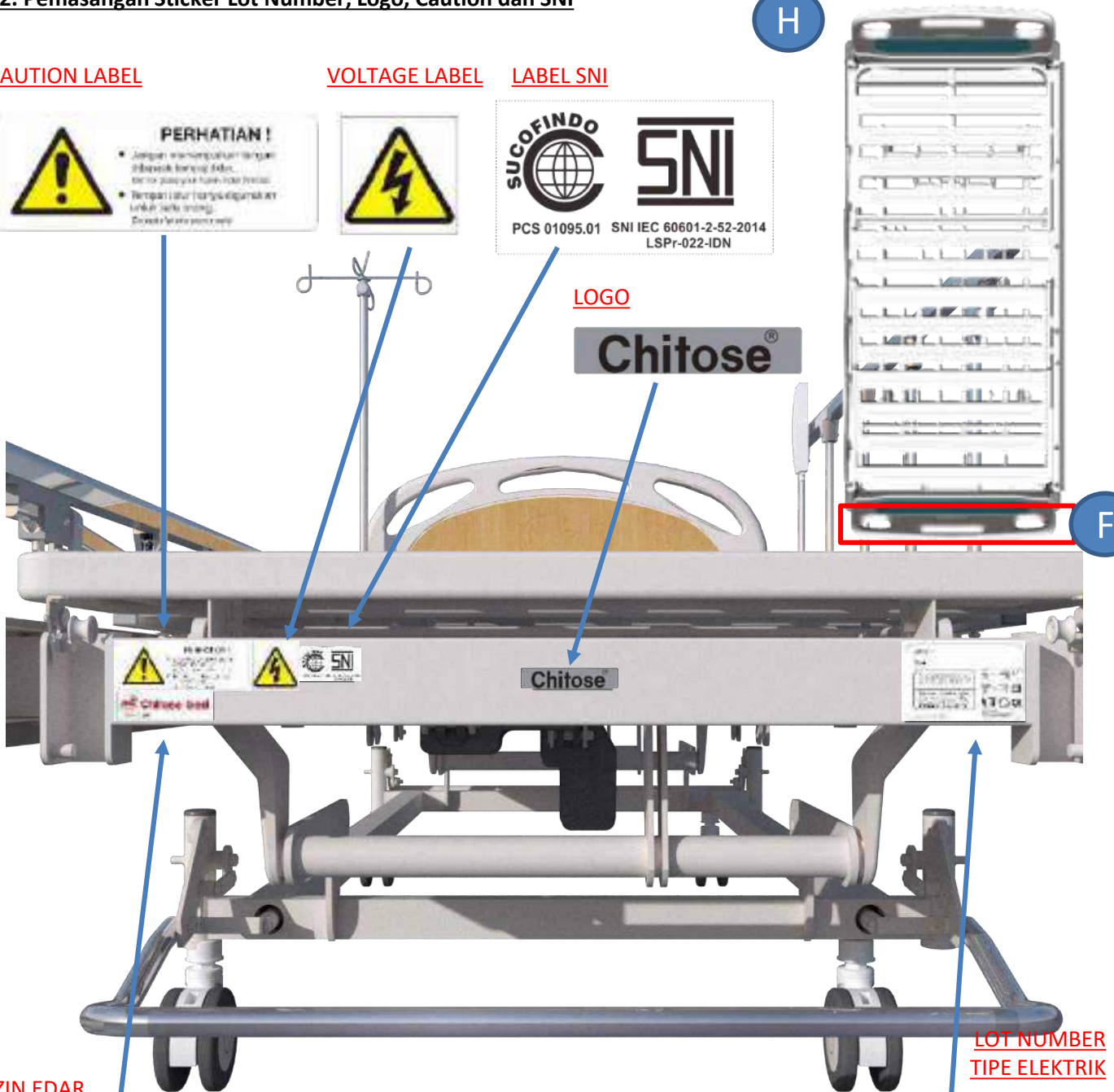

**IZIN EDAR
 KEMENKES**



**LOT NUMBER
 TIPE ELEKTRIK**

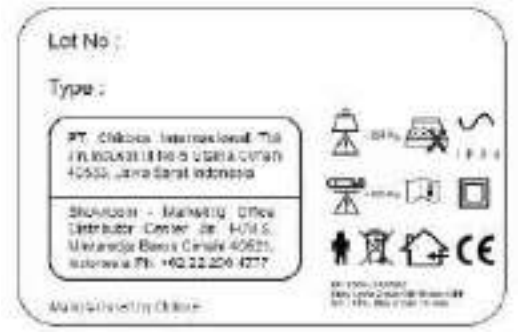

**Posisi Pemasangan ;
 Main Frame di area Foot Board**

**Pastikan :
 Pemasangan Rata / tidak miring
 Sticker melekat dengan sempurna
 Label SNI memakai ukuran besar**

Direvisi Oleh	Revisi	Disetujui Oleh	Tgl.Efektif
	△		
	△		
	△		

**3. Pemasangan Sticker Lot Number, Logo, dan Caution pada
 Folding Side Rail**

CAUTION LABEL

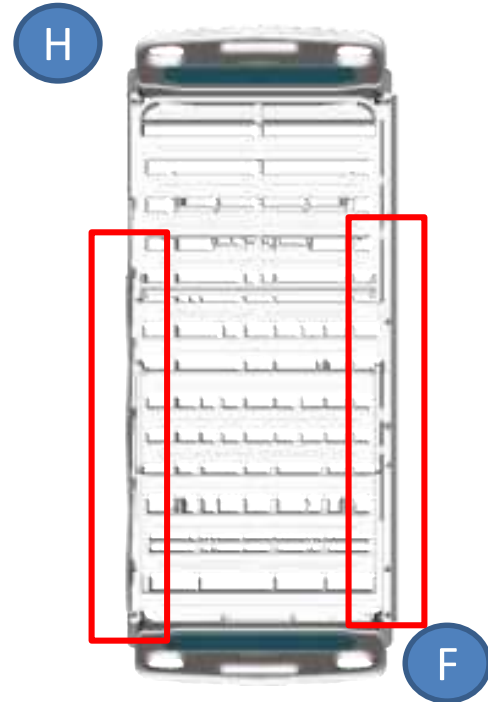

LOGO

LABEL SNI

LOT NUMBER
 AKSESORIS



Posisi Pemasangan ;
 Folding Side Rail

Pastikan :
 Pemasangan Rata / tidak miring
 Sticker melekat dengan sempurna
 Label SNI memakai ukuran kecil

Direvisi Oleh	Revisi	Disetujui Oleh	Tgl.Efektif
	△		
	△		
	△		

4. Pemasangan Sticker Logo pada H/F BOARD

H/F Board DX

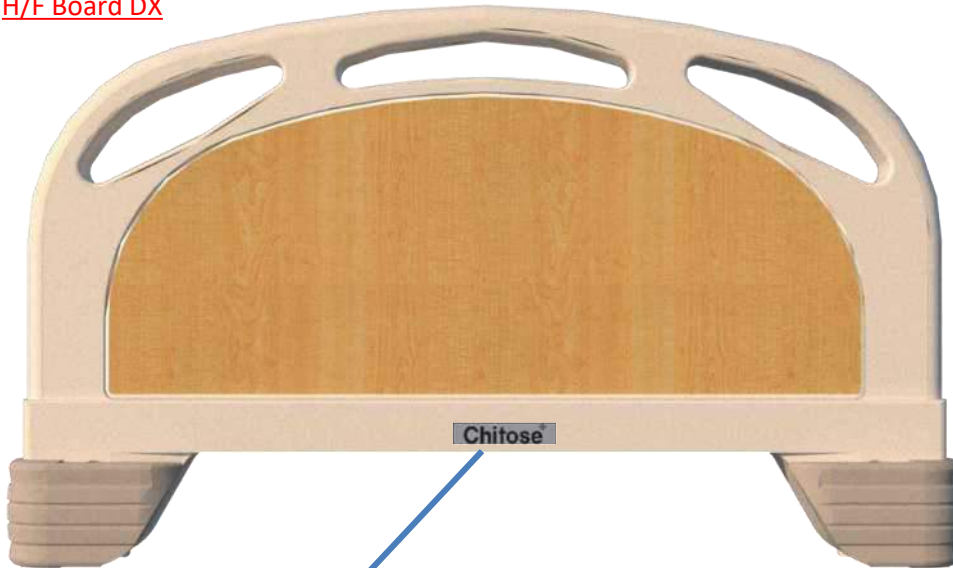

LOGO



H/F Board JP



H/F Board ST



Posisi Pemasangan :
Head/Foot Board (menghadap ke luar)

Pastikan :
Pemasangan Rata / tidak miring
Sticker merekat dengan sempurna

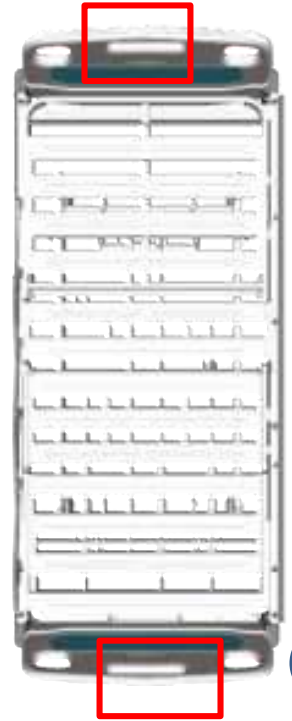

Direvisi Oleh	Revisi	Disetujui Oleh	Tgl.Efektif
	△		
.	△		
.	△		

5. Pemasangan Sticker Lot Number dan label SNI pada IV Pole / Irrigator Bar



LABEL SNI



LOT NUMBER
AKSESORIS



Posisi Pemasangan :
IV Pole / Irrigator Bar

Pastikan :
Pemasangan Rata / tidak miring
Sticker merekat dengan sempurna
Label SNI memakai ukuran kecil

Direvisi Oleh	Revisi	Disetujui Oleh	Tgl.Efektif
	△		
	△		
	△		

6. Pemasangan Sticker Lot Number pada Cabinet

LOT NUMBER
AKSESORIS



LOGO



Posisi Pemasangan :
Cabinet

Pastikan :
Pemasangan Rata / tidak miring
Sticker merekat dengan sempurna

Direvisi Oleh	Revisi	Disetujui Oleh	Tgl.Efektif
	△		
	△		
	△		

7. Pemasangan Sticker Lot Number pada Over Bed Table

LOT NUMBER
AKSESORIS



Posisi Pemasangan :
Over Bed Table

Pastikan :
Pemasangan Sticker Lot Number arah Vertikal
Pemasangan Rata / tidak miring
Sticker merekat dengan sempurna