

## Cara pemasangan Foot Board & Head Board

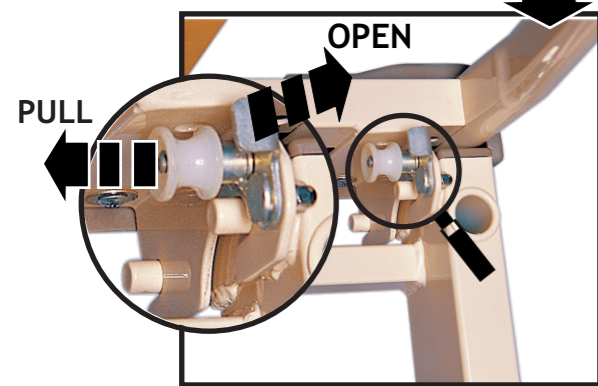

## Pemasangan Folding Side Rail

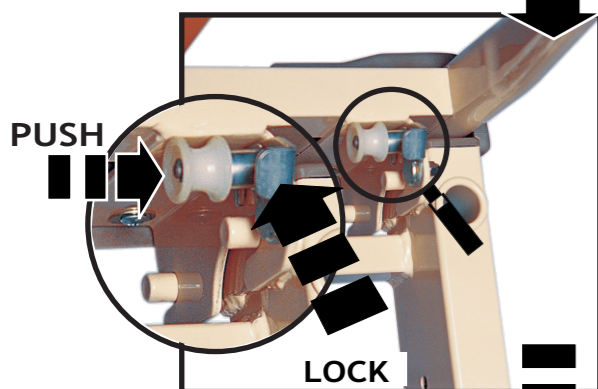
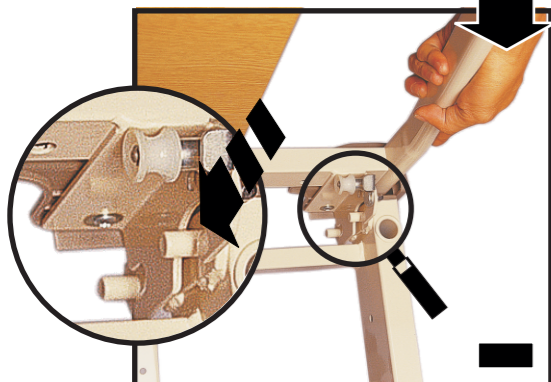
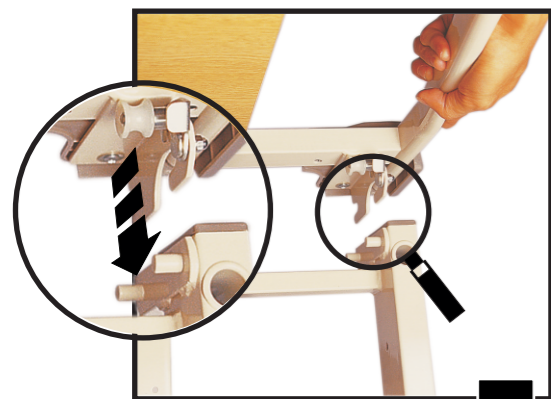
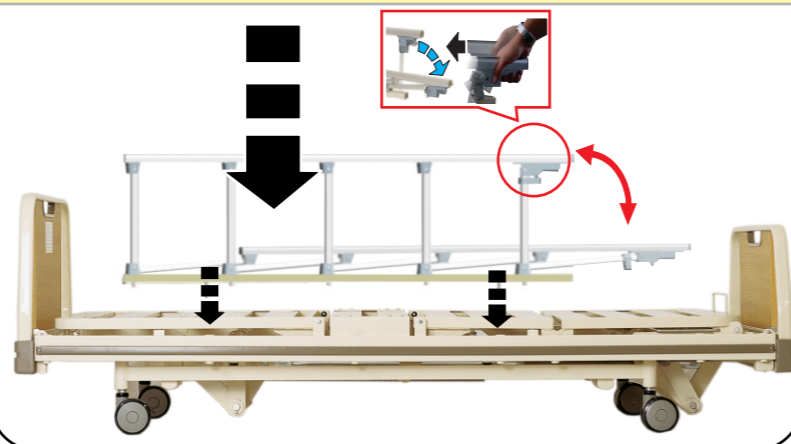

## Sistem Crank & Cylinder Gas

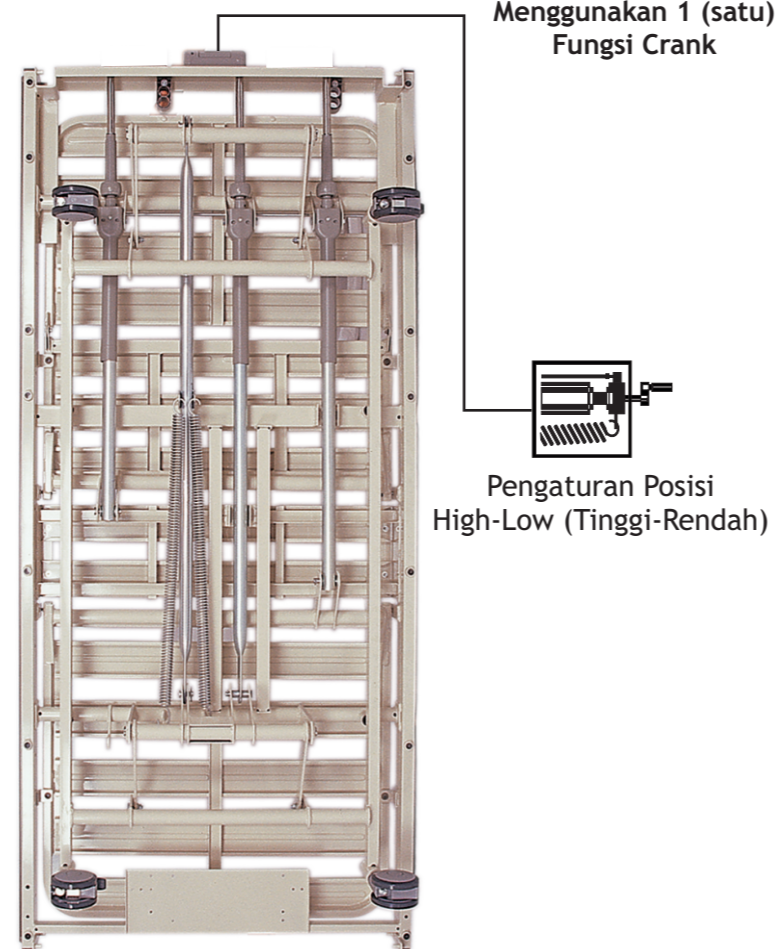

Manufactured by :  
PT. Chitose Indonesia Mfg

**Chitose**<sup>®</sup>  
INNOVATION BY YOUR INSPIRATION



# Nursing Bed

## Health Therapy Product

Type **CB-3011D**

Praktis  
Nyaman  
Kuat  
Aman  
Bersih  
&  
Tenang



**Chitose**<sup>®</sup>  
INNOVATION BY YOUR INSPIRATION



## Ergonomis

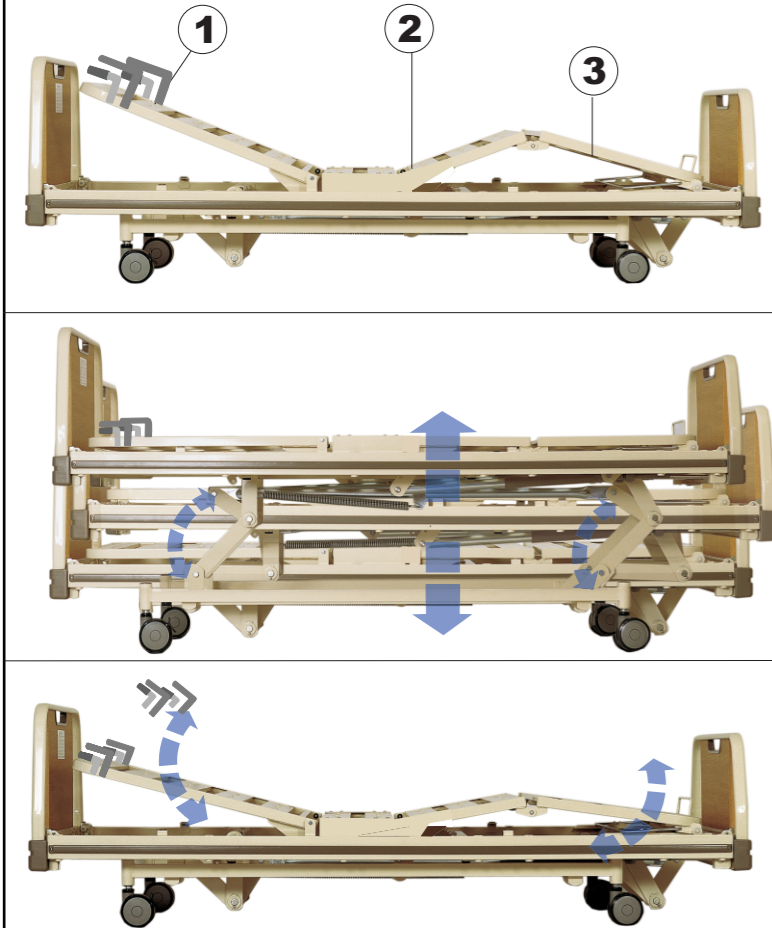

Bagian penyangga tubuh yang terdiri dari perpaduan tiga panel baja yang kokoh, membantu bagian kepala, punggung, dan kaki pengguna berada pada posisi yang nyaman.

## Double Lock



Independent Lock Caster System pada roda depan dan roda belakang untuk menjamin keamanan dan kestabilan saat bed berhenti.

## Sistem Crank (Hi-Low)



Bentuk Crank yang menarik untuk mengatur posisi bed sesuai kebutuhan.

## Desain Panel

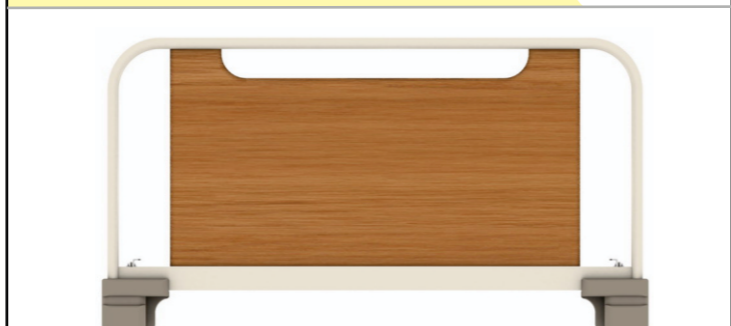

Desain sekat pada kaki (foot board) dan kepala (head board) menggunakan bahan kayu yang mencitrakan kesan simple, aman, bersih, sehat dan alami.

## Dimensi

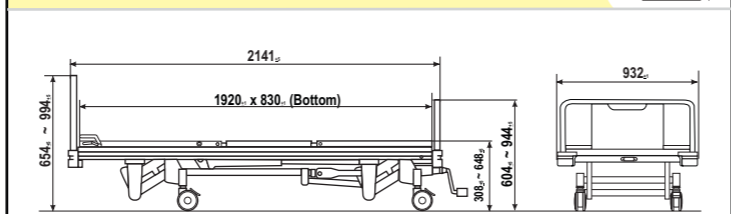

## Sistem Pengoperasian Crank

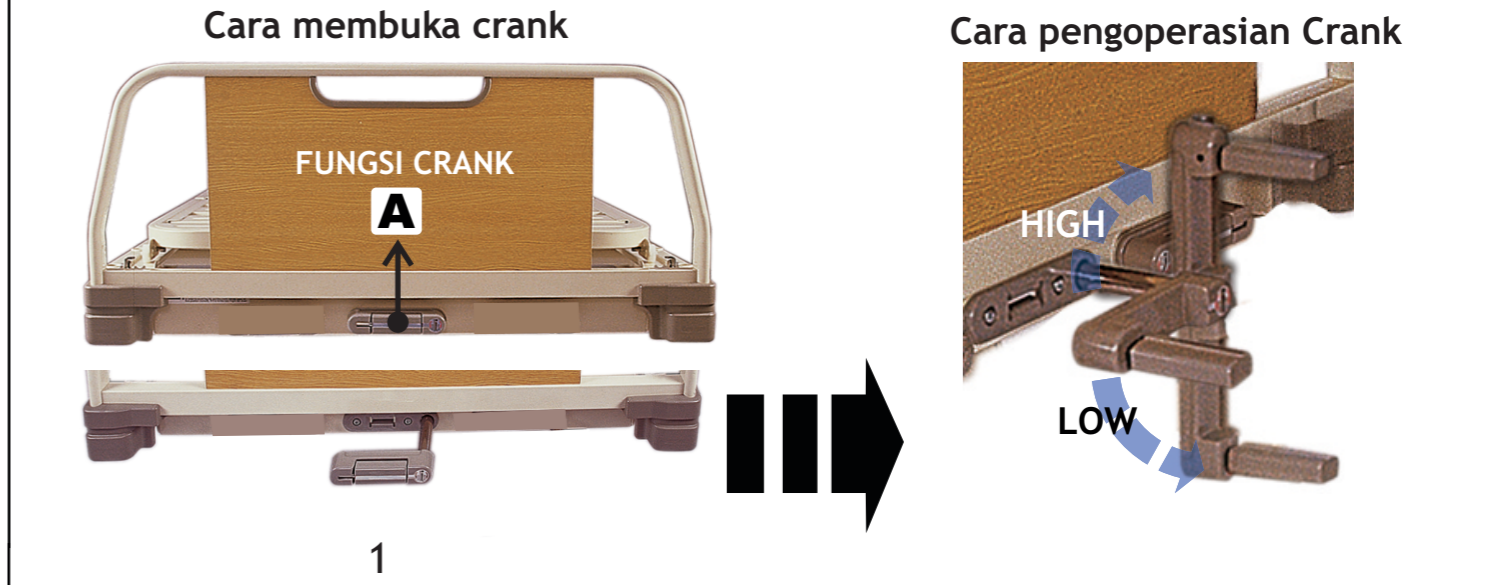

\* Pengaturan posisi back rest dengan menggunakan sistem Cylinder Gas

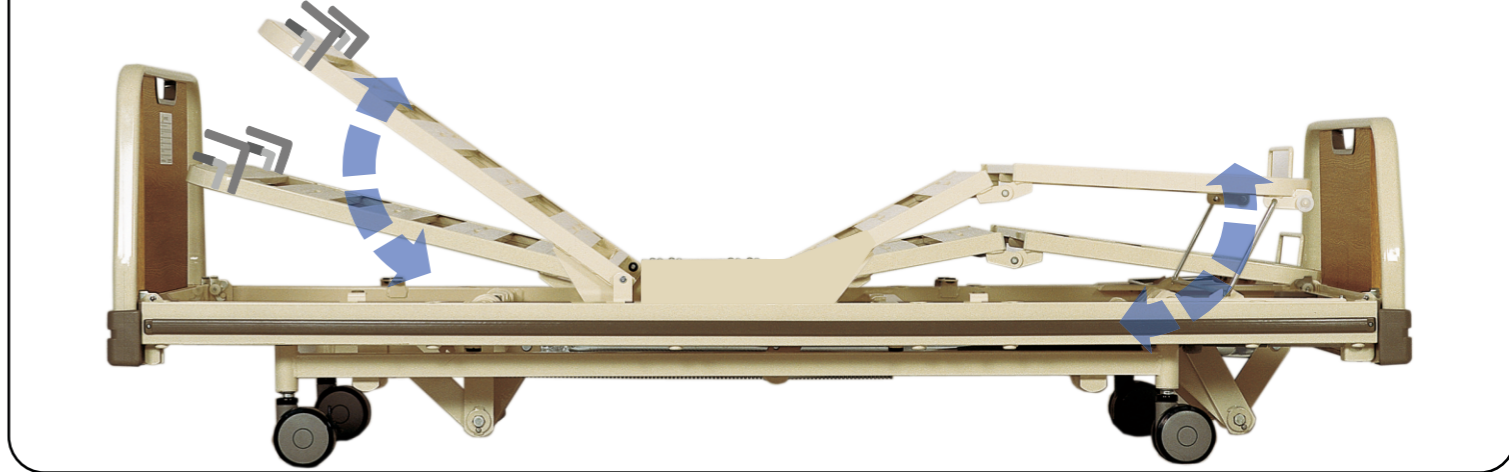

## Pengaturan Posisi Tinggi Bed

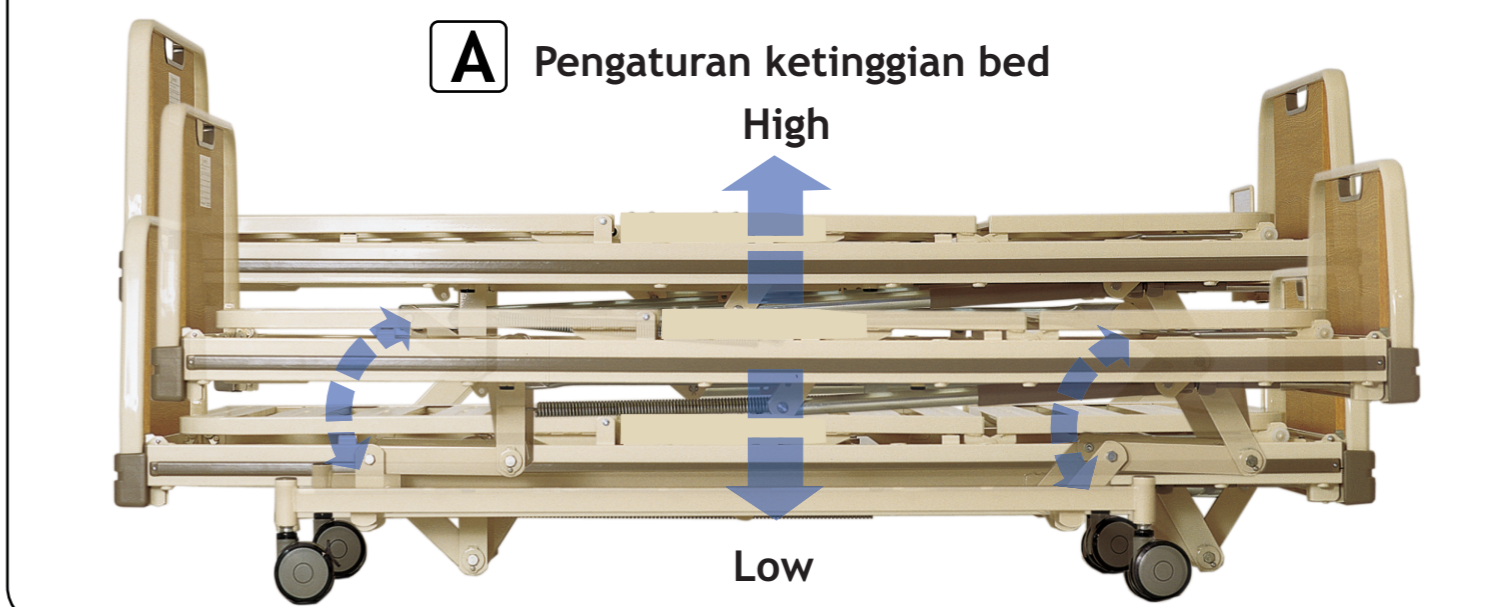

## Cara pemasangan Foot Board & Head Board

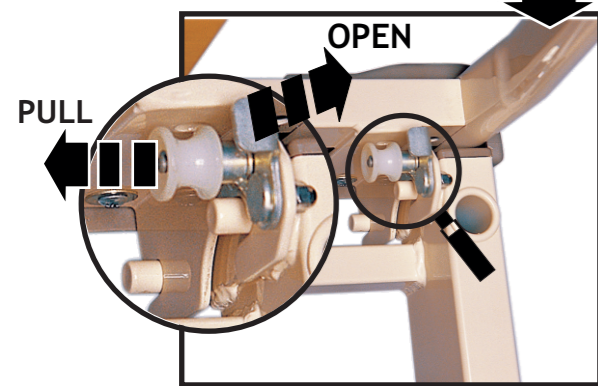
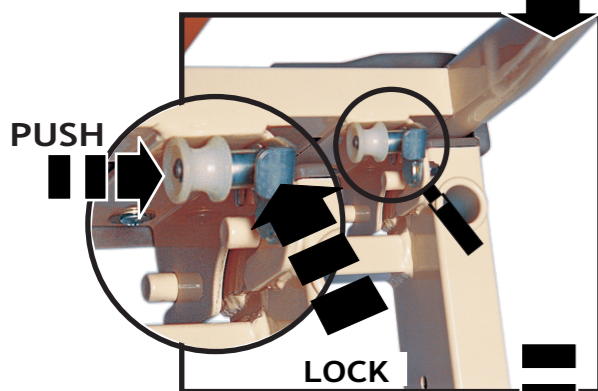
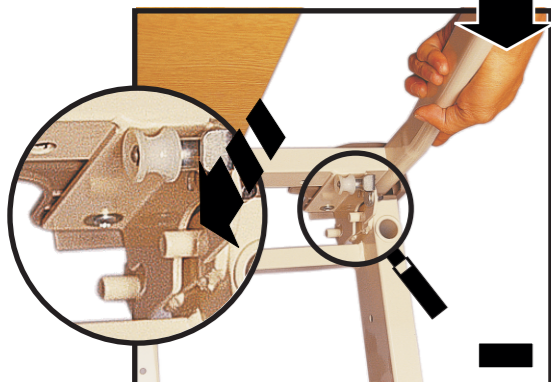
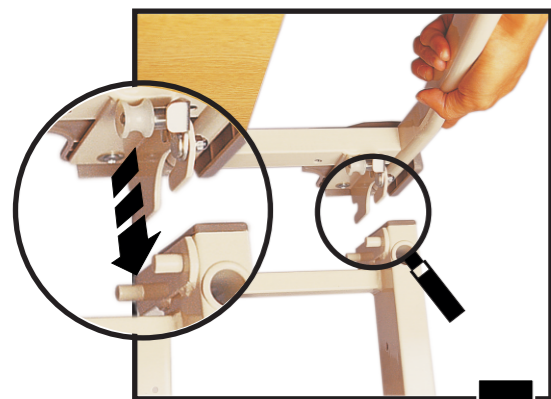

## Pemasangan Folding Side Rail

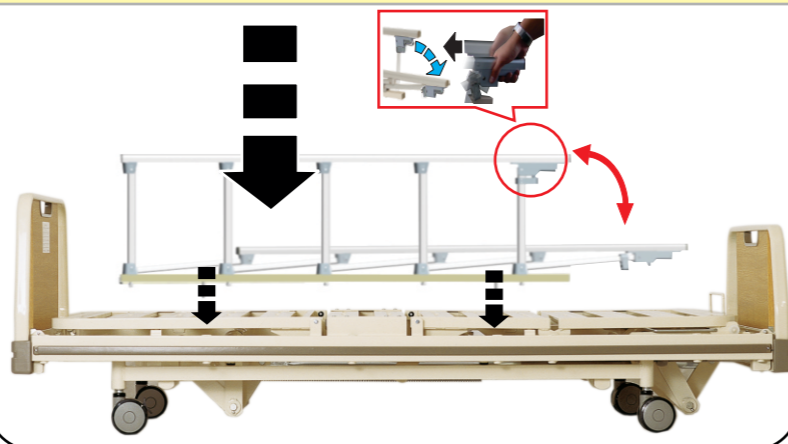

## Sistem Crank & Cylinder Gas

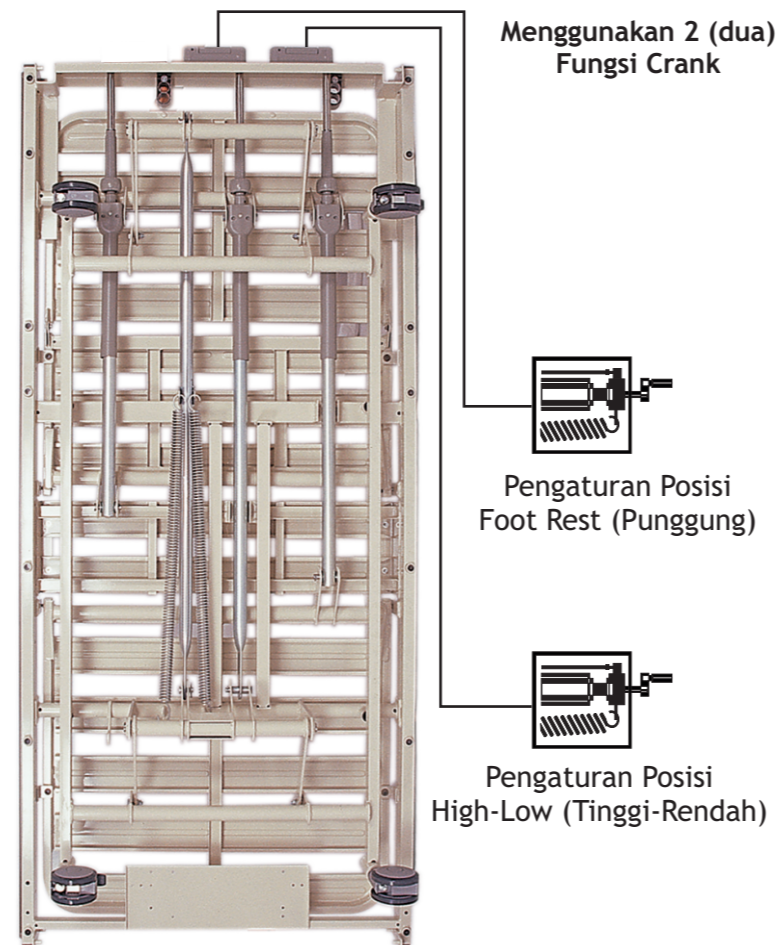

Manufactured by :  
PT. Chitose Indonesia Mfg

**Chitose**<sup>®</sup>  
INNOVATION BY YOUR INSPIRATION



# Nursing Bed

## Health Therapy Product

Type **CB-3012D**

Praktis  
Nyaman  
Kuat  
Aman  
Bersih  
&  
Tenang

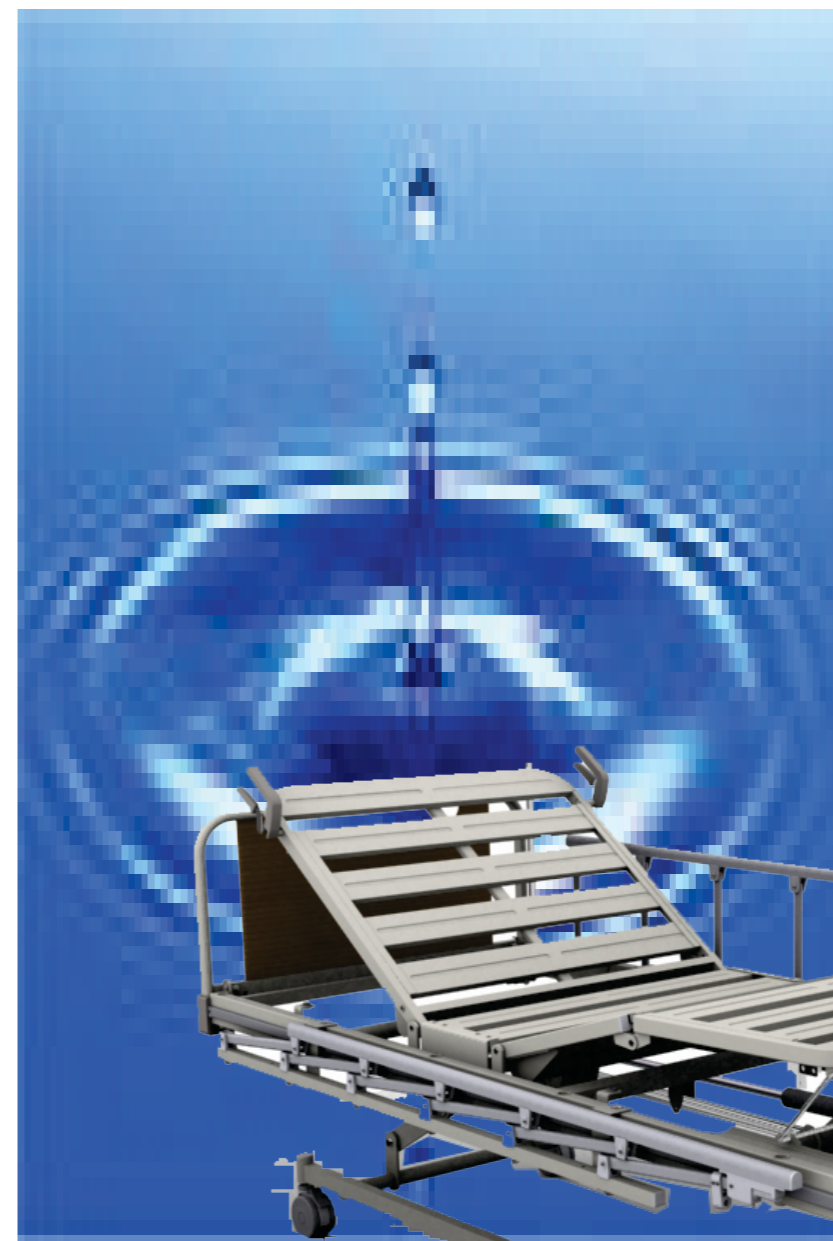



## Ergonomis

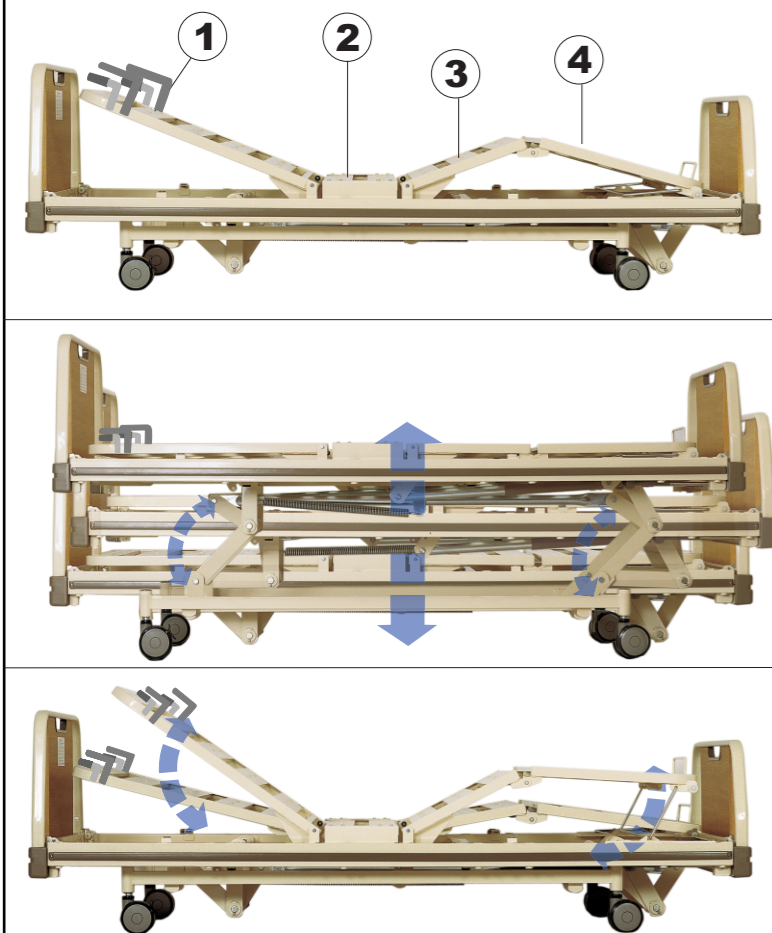

Bagian penyangga tubuh yang terdiri dari perpaduan empat panel baja yang kokoh, membantu bagian kepala, punggung, dan kaki pengguna berada pada posisi yang nyaman.

## Double Lock



Independent Lock Caster System pada roda depan dan roda belakang untuk menjamin keamanan dan kestabilan saat bed berhenti.

## Sistem Crank (Hi-Low)



Bentuk Crank yang menarik untuk mengatur posisi bed sesuai kebutuhan.

## Desain Panel

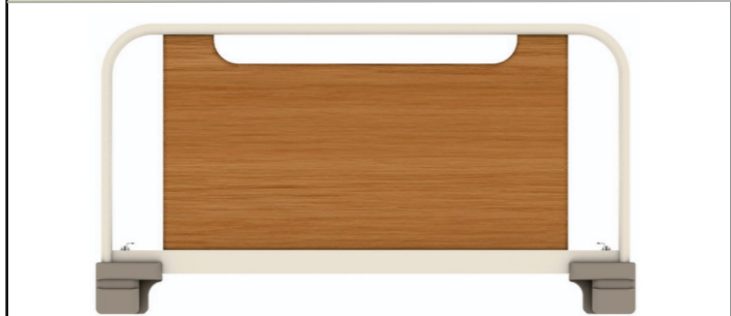

Desain sekat pada kaki (foot board) dan kepala (head board) menggunakan bahan kayu yang mencitrakan kesan simple, aman, bersih, sehat dan alami.

## Dimensi

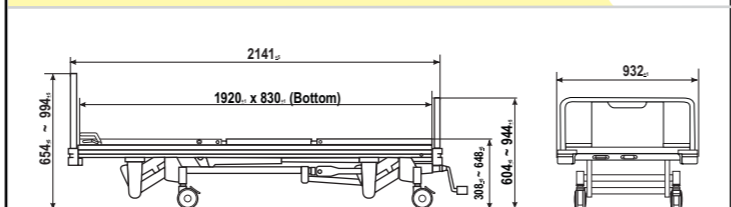

## Sistem Pengoperasian Crank

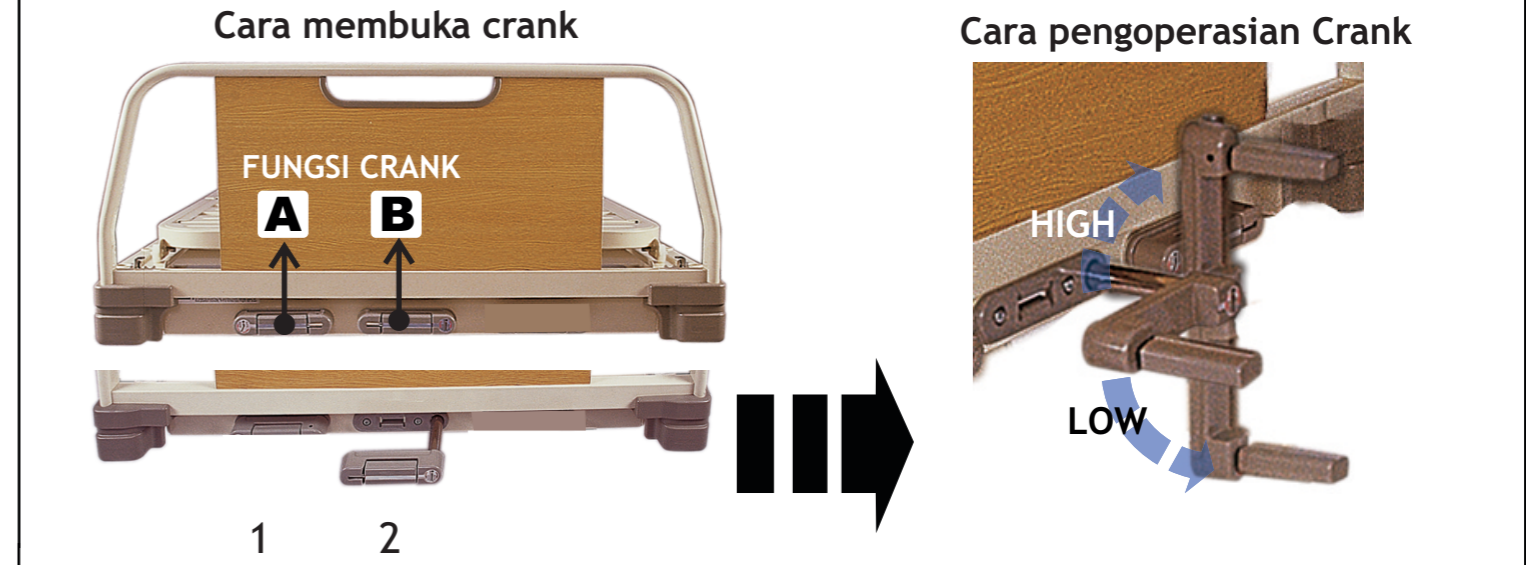

\* Pengaturan posisi back rest menggunakan sistem Cylinder Gas  
A Pengaturan posisi foot rest menggunakan sistem Crank

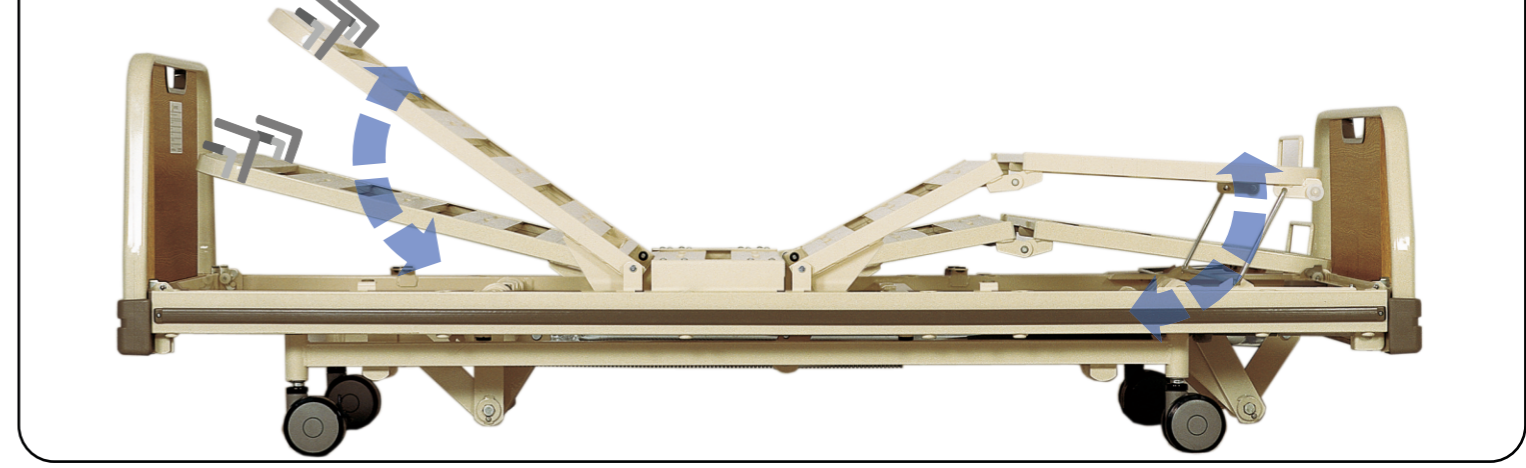

## Pengaturan Posisi Tinggi Bed

