

**Cara pemasangan  
Foot Board & Head Board**

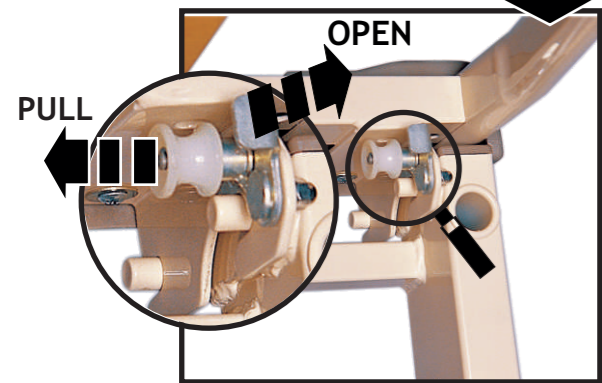

**Pemasangan Folding Side Rail**

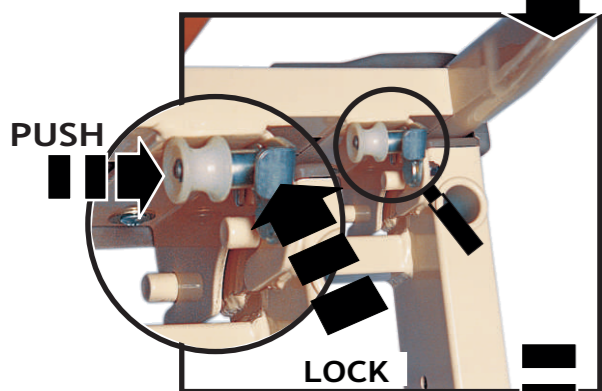
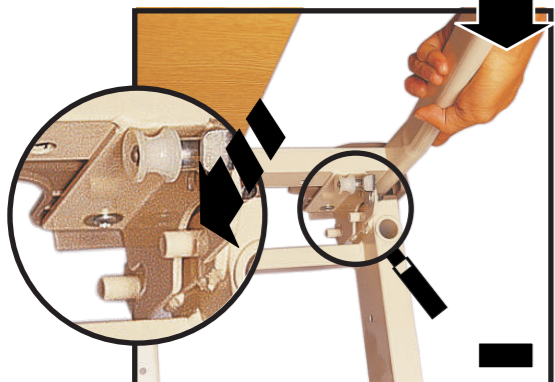
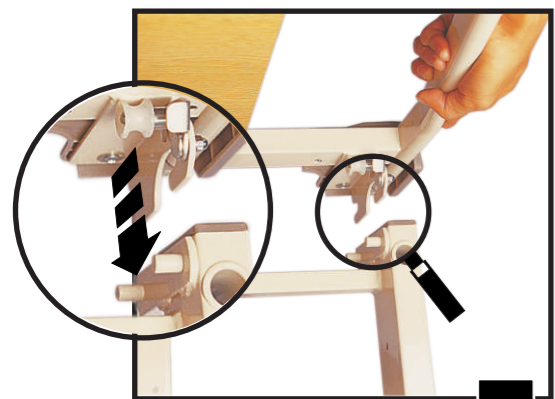
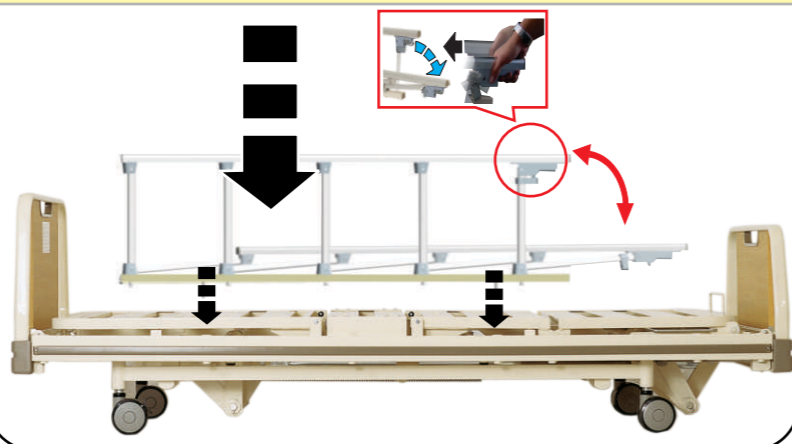

**Sistem Crank & Cylinder Gas**

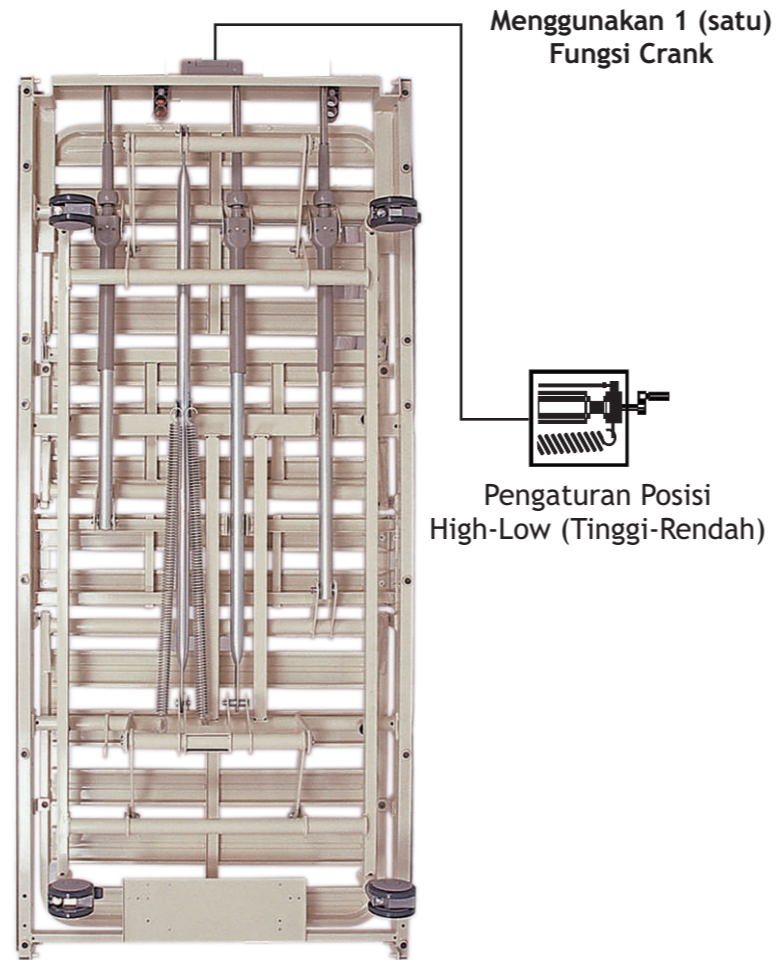

Manufactured by :  
PT. Chitose Internasional Tbk

**Chitose**<sup>®</sup>  
INNOVATION BY YOUR INSPIRATION

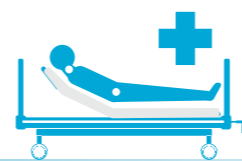

**Nursing Bed**

**Health Therapy Product**

Type **CB-7011D**

Praktis  
Nyaman  
Kuat  
Aman  
Bersih  
&  
Tenang



**Chitose**<sup>®</sup>  
INNOVATION BY YOUR INSPIRATION



## Ergonomis

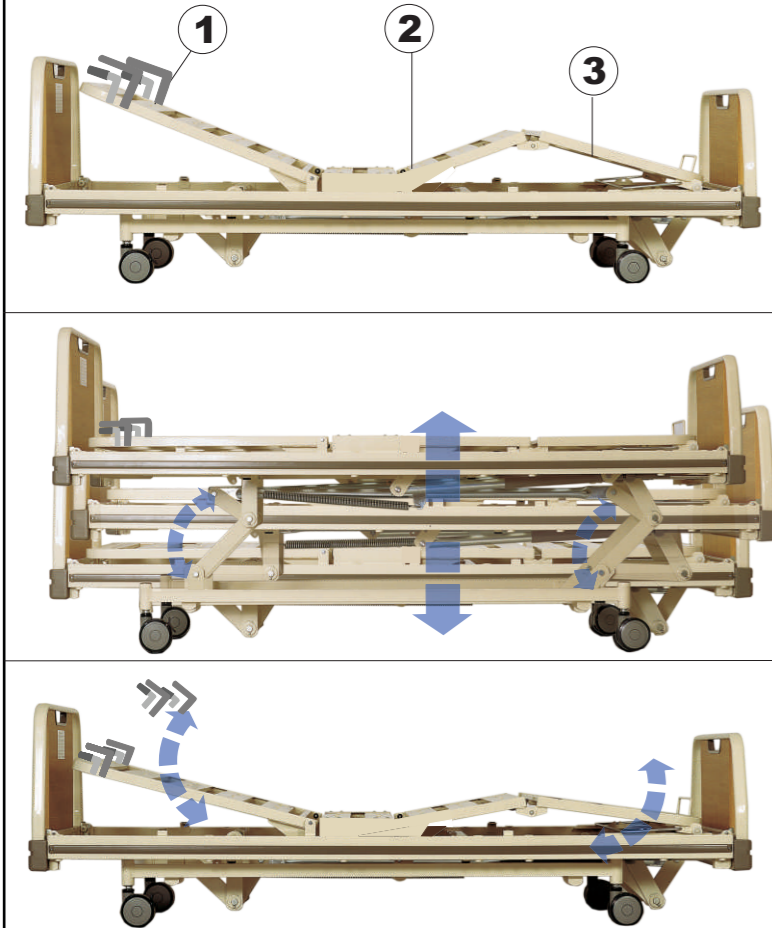

Bagian penyangga tubuh yang terdiri dari perpaduan tiga panel baja yang kokoh, membantu bagian kepala, punggung, dan kaki pengguna berada pada posisi yang nyaman.

## Double Lock



Independent Lock Caster System pada roda depan dan roda belakang untuk menjamin keamanan dan kestabilan saat bed berhenti.

## Sistem Crank (Hi-Low)



Bentuk Crank yang menarik untuk mengatur posisi bed sesuai kebutuhan.

## Desain Panel

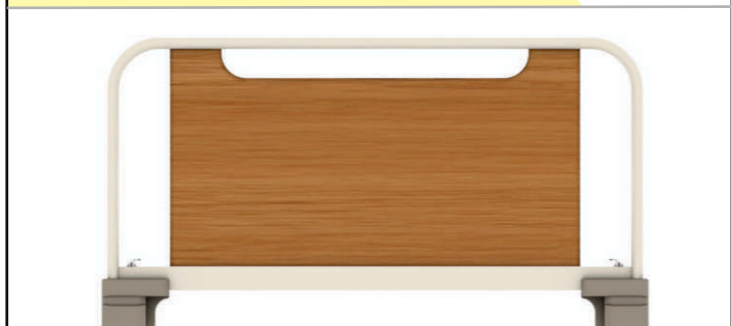

Desain sekat pada kaki (foot board) dan kepala (head board) menggunakan bahan kayu yang mencitrakan kesan simple, aman, bersih, sehat dan alami.

## Dimensi

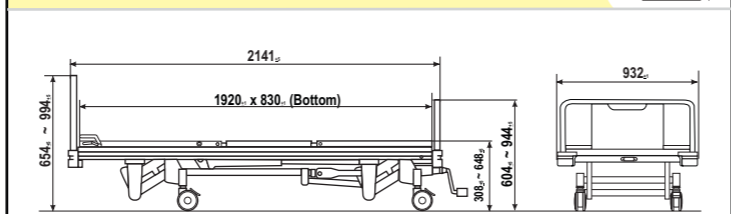

## Sistem Pengoperasian Crank

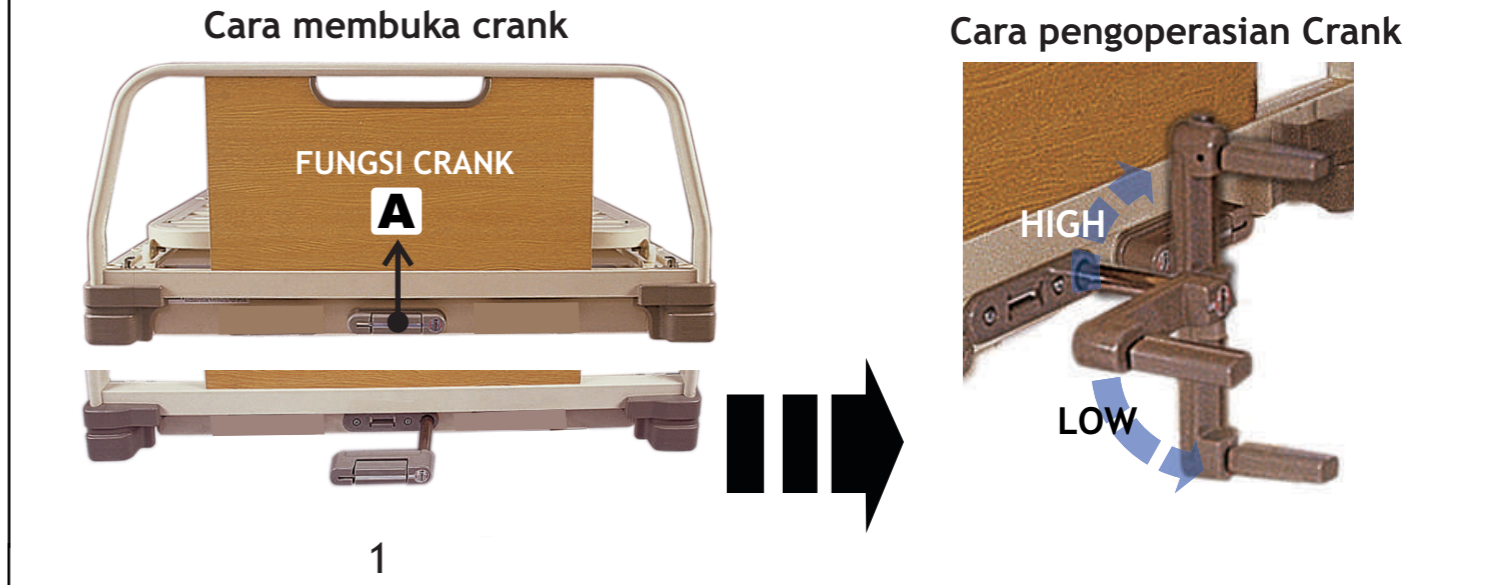

\* Pengaturan posisi back rest dengan menggunakan sistem Cylinder Gas

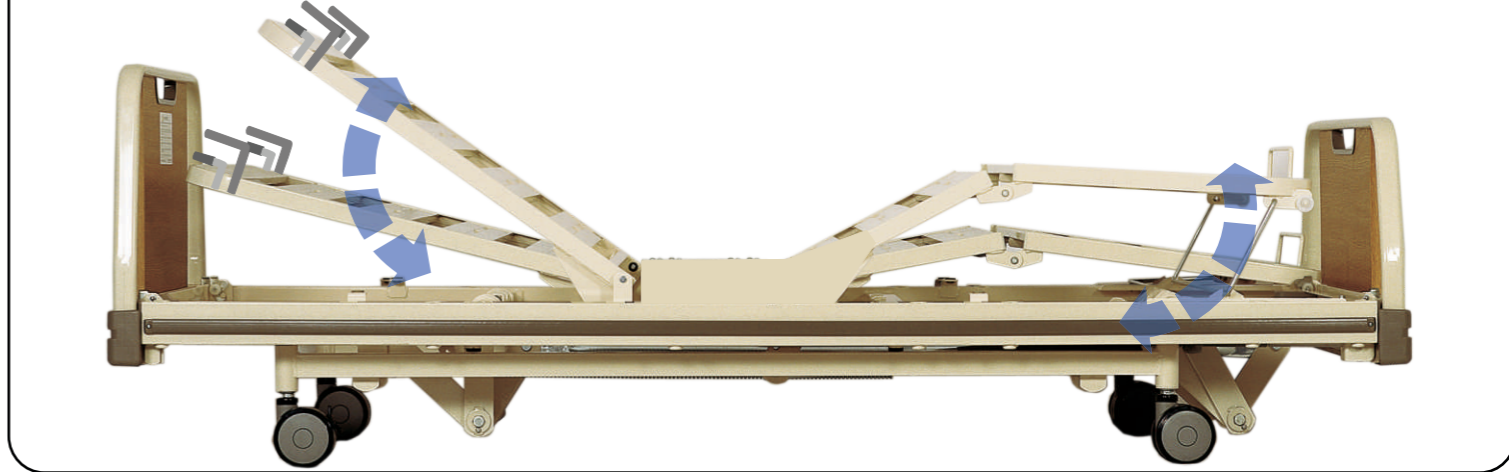

## Pengaturan Posisi Tinggi Bed

