

Cara pemasangan Foot Board & Head Board

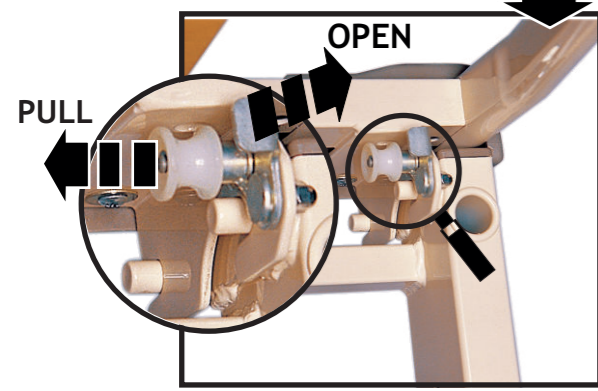

Pemasangan Folding Side Rail

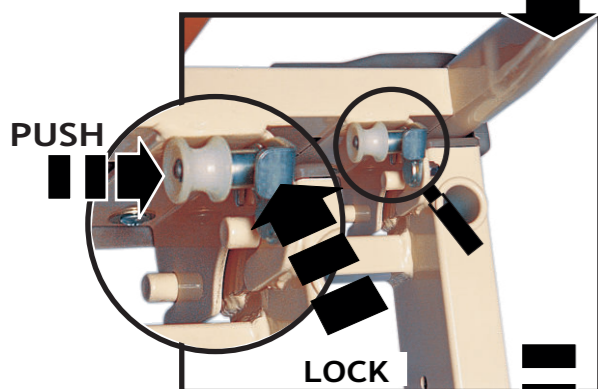
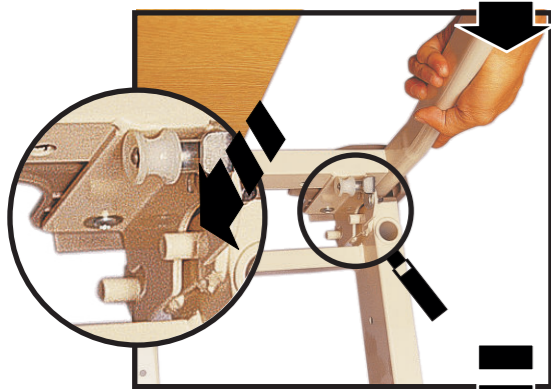
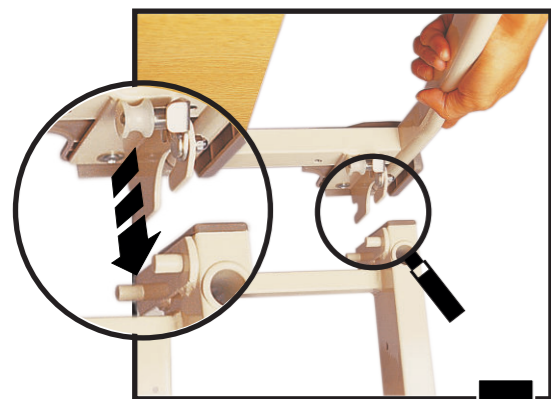
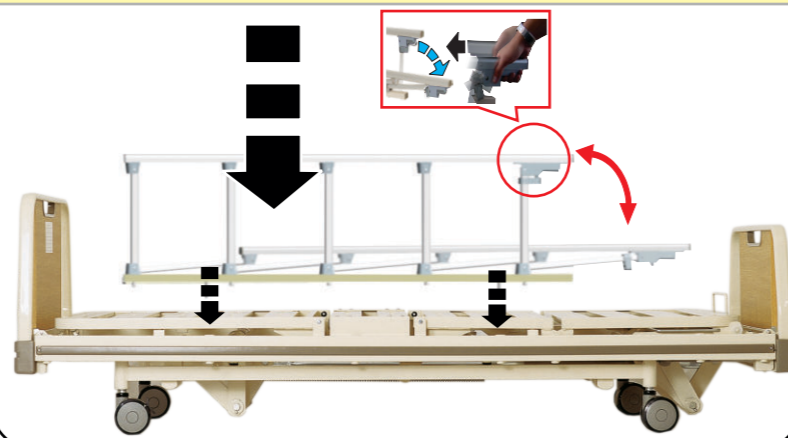

Sistem Crank

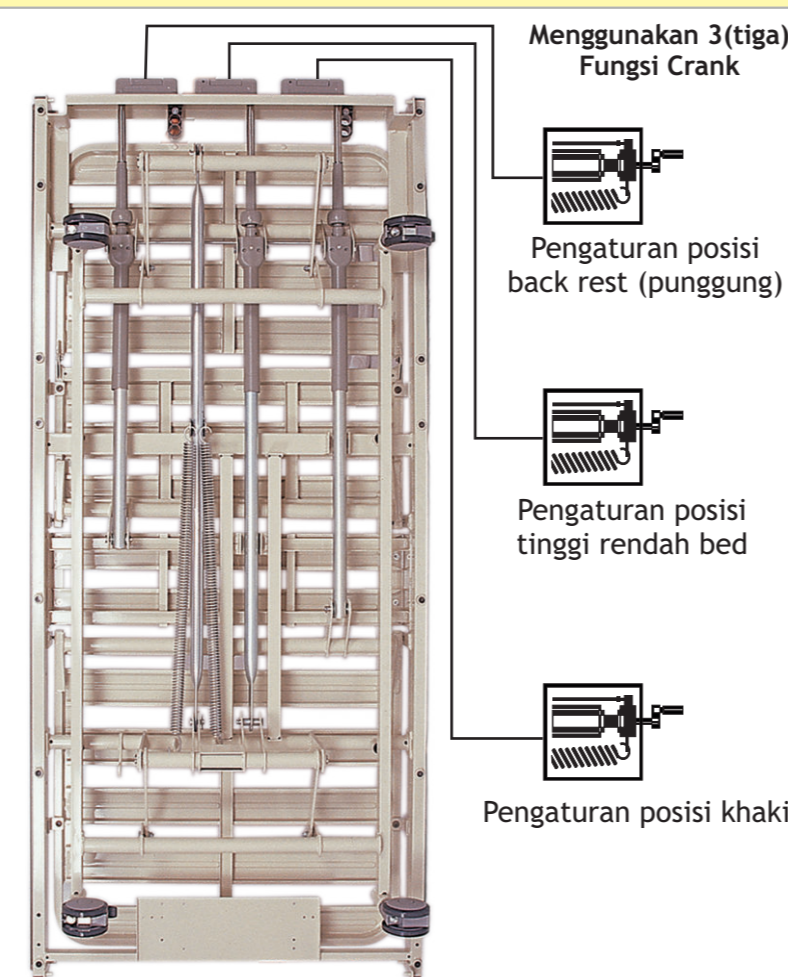

Manufactured by :
PT. Chitose Indonesia Mfg

Chitose[®]
INNOVATION BY YOUR INSPIRATION

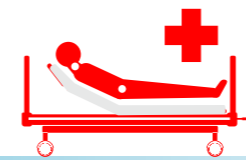

Nursing Bed

Health Therapy Product

Type **CB-3003D**

Praktis
Nyaman
Kuat
Aman
Bersih
&
Tenang

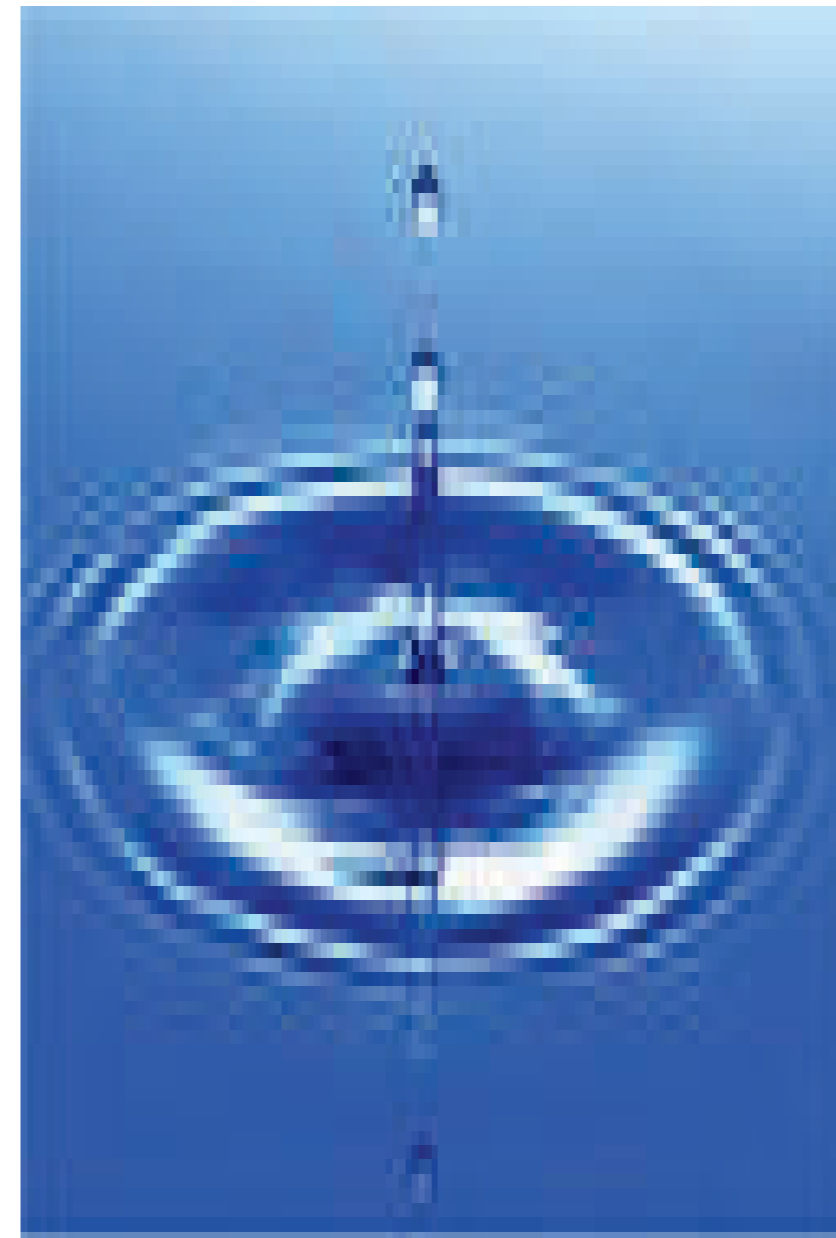



Ergonomis

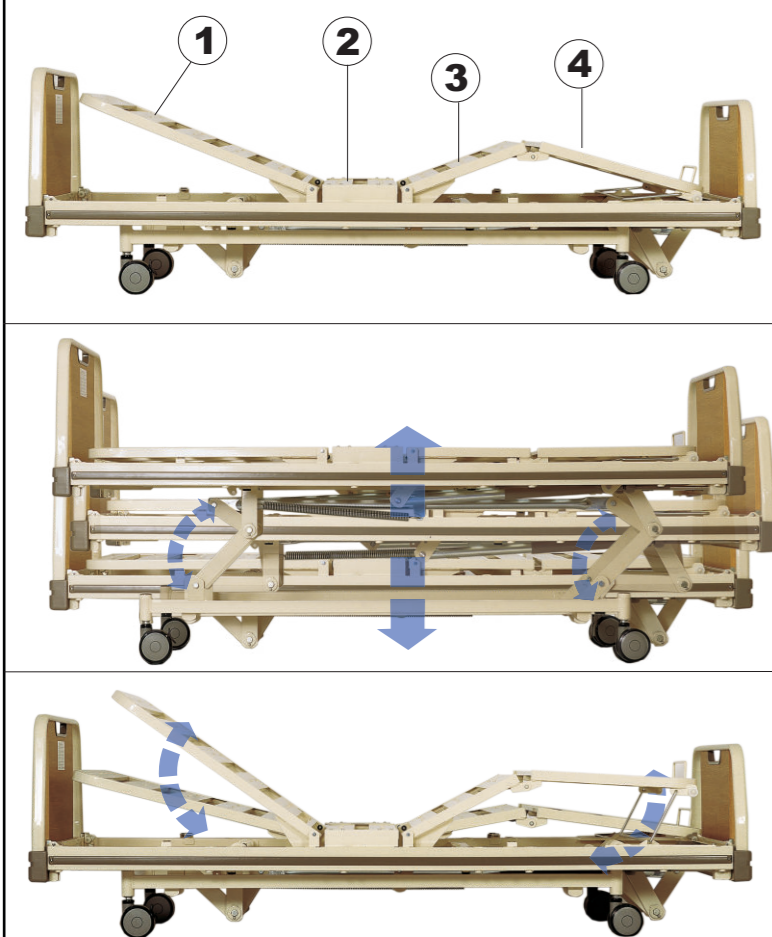

Bagian penyangga tubuh yang terdiri dari perpaduan empat panel baja yang kokoh, membantu bagian kepala, punggung, dan kaki pengguna berada pada posisi yang nyaman.

Double Lock



Independent Lock Caster System pada roda depan dan roda belakang untuk menjamin keamanan dan kestabilan saat bed berhenti.

Sistem Crank (Hi-Low)



Bentuk Crank yang menarik untuk mengatur posisi bed sesuai kebutuhan.

Desain Panel

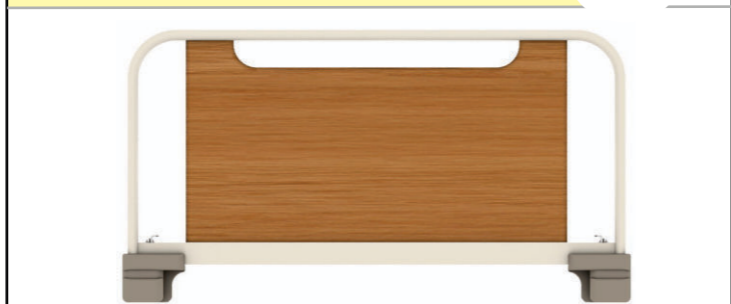

Desain sekat pada kaki (foot board) dan kepala (head board) menggunakan bahan kayu yang mencitrakan kesan simple, aman, bersih, sehat dan alami.

Dimensi

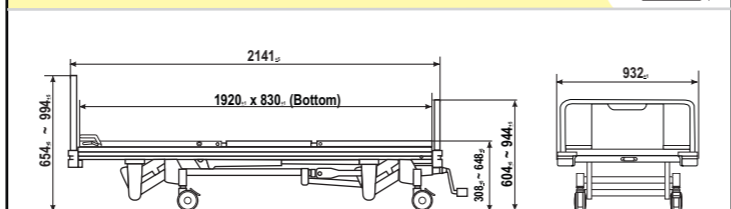

Sistem Pengoperasian Crank

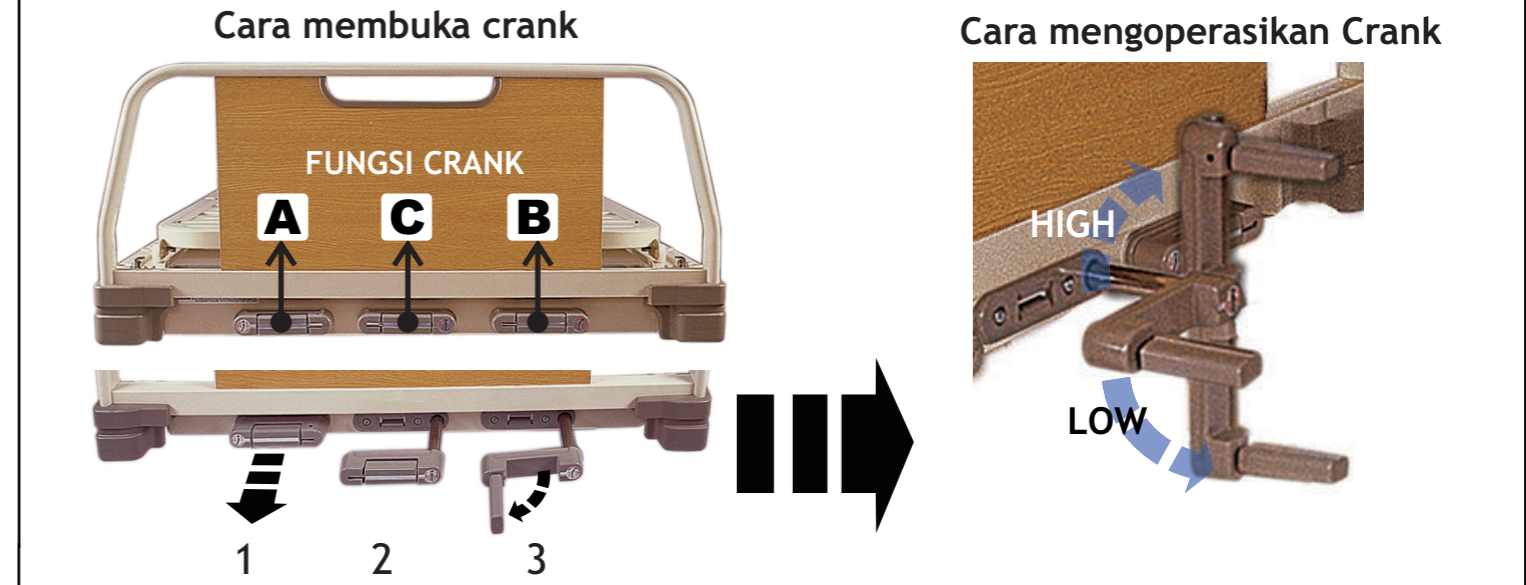

A Pengaturan posisi back rest menggunakan sistem Crank
B Pengaturan posisi foot rest menggunakan sistem Crank

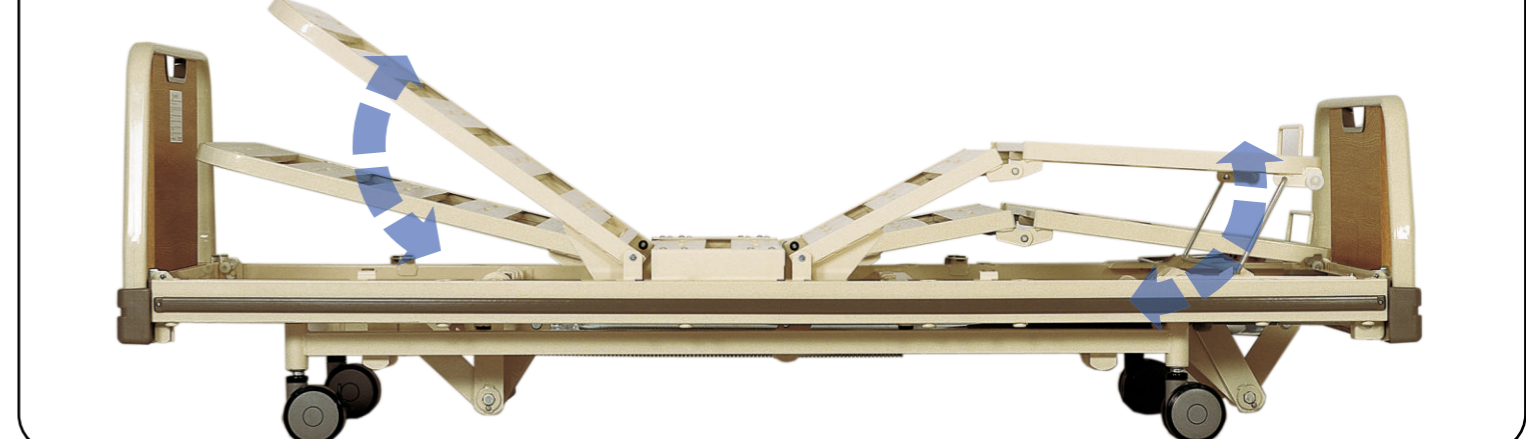

Pengaturan Posisi Tinggi Bed

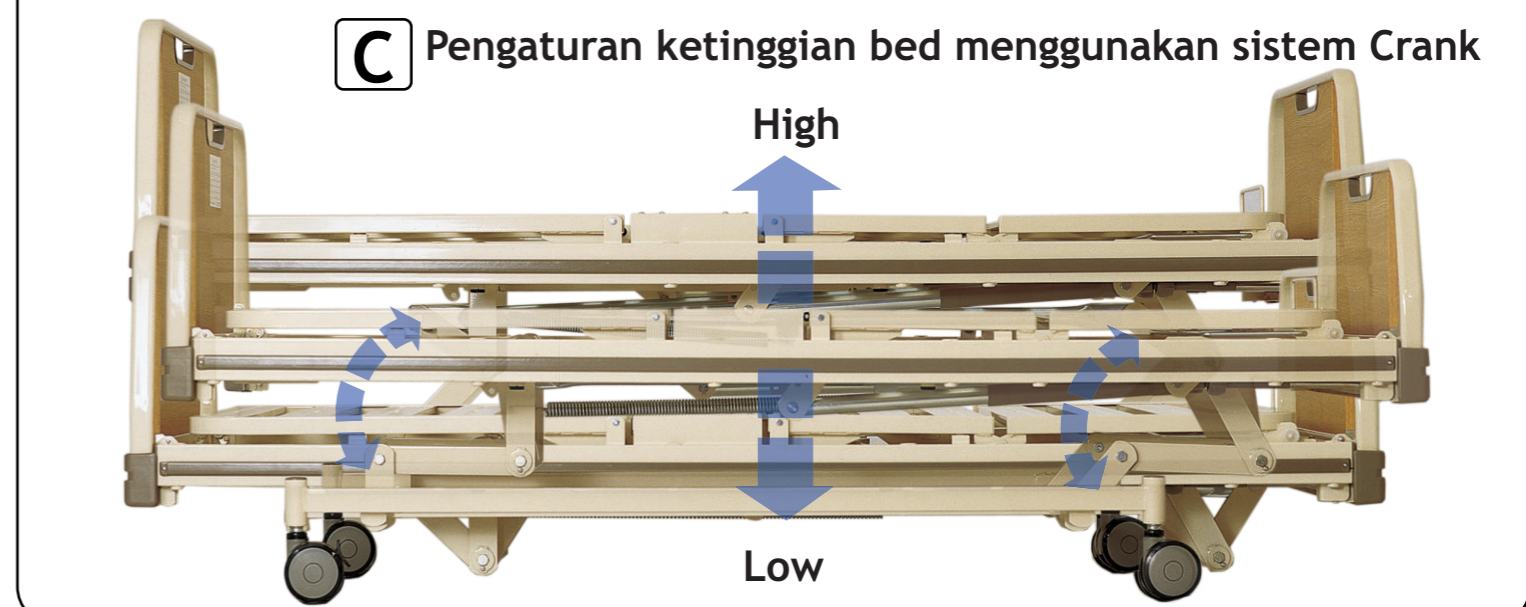

C Pengaturan ketinggian bed menggunakan sistem Crank