

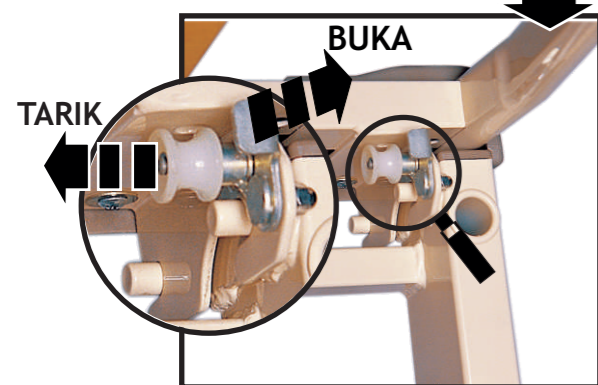

Cara Pemasangan Foot Board & Head Board

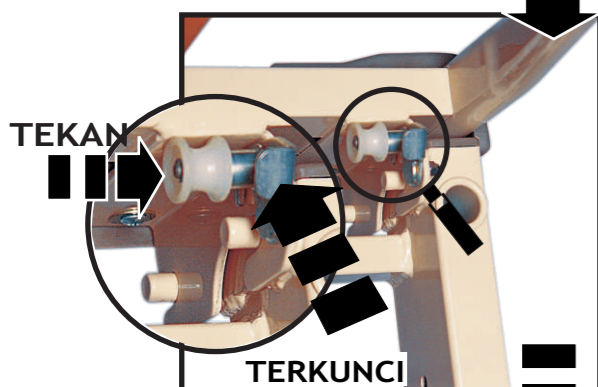

Dudukan Side Rail

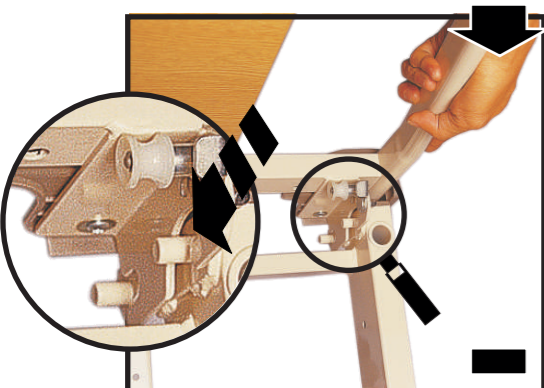
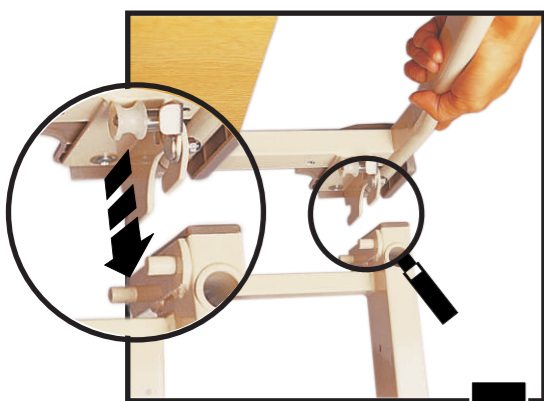
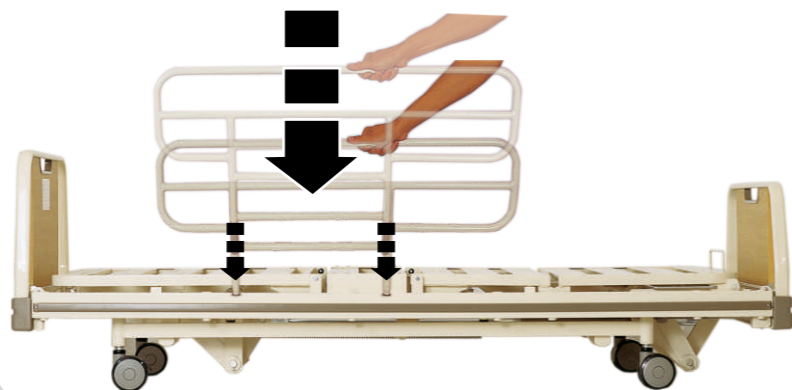

Sistem Motor

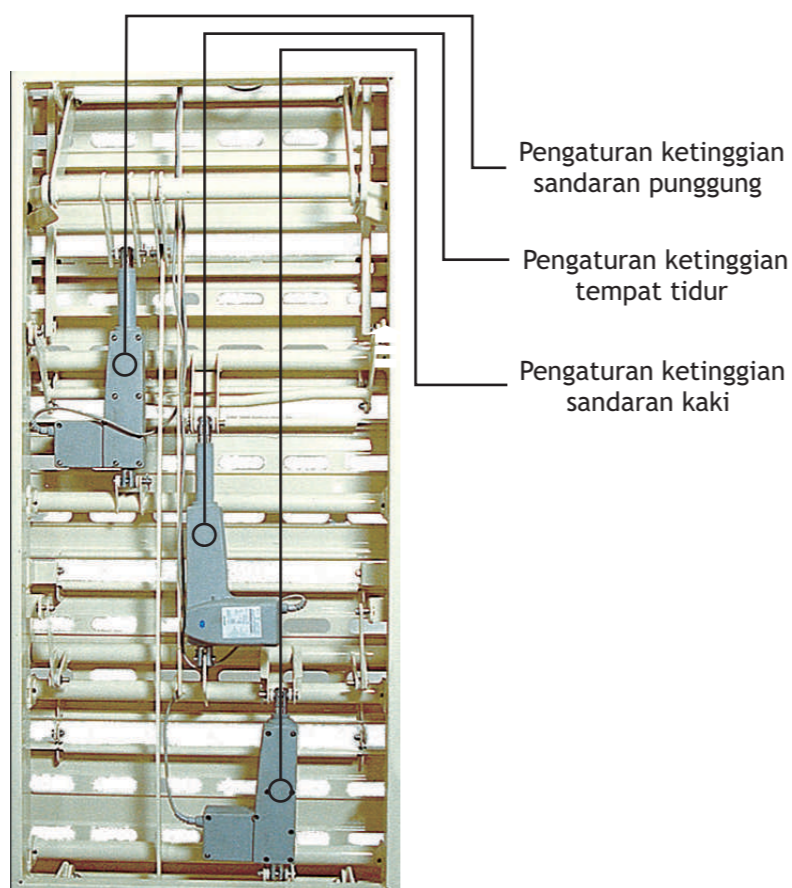

Manufactured by :
PT. Chitose Internasional Tbk

Chitose[®]
INNOVATION BY YOUR INSPIRATION

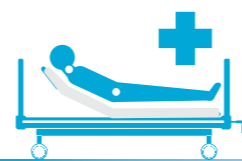

Nursing Bed

Health Therapy Product

Type **CB-3300D**

P r a k t i s
N y a m a n
K u a t
A m a n
B e r s i h
&
T e n a n g



Chitose[®]
INNOVATION BY YOUR INSPIRATION



Ergonomis

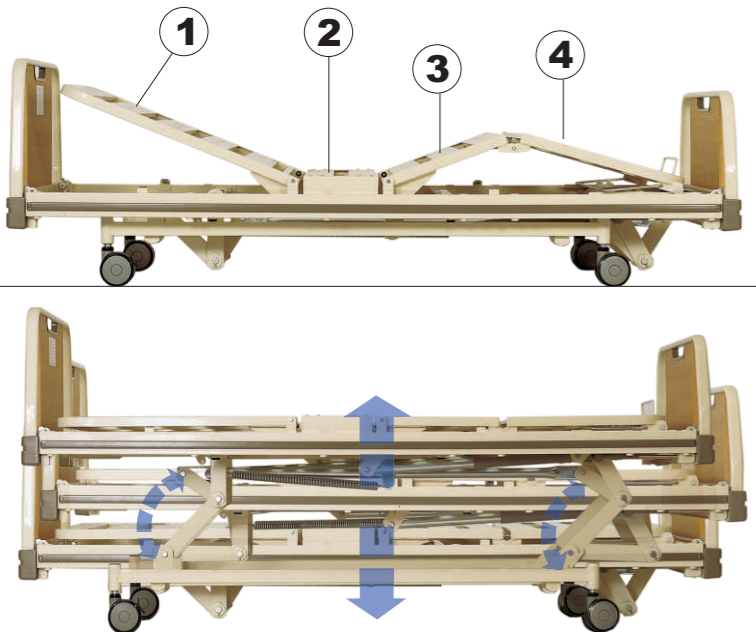

Bagian penyangga tubuh yang terdiri dari perpaduan empat panel baja yang kokoh, membantu bagian kepala, punggung,

Kunci Ganda



Independent Lock Caster System pada roda depan dan roda belakang untuk menjamin keamanan dan kestabilan saat bed berhenti.

Design Panel



Desain sekat pada kaki (foot board) dan kepala (head board) menggunakan bahan kayu yang mencitrakan kesan simple, aman, bersih, sehat dan alami.

Dimensi

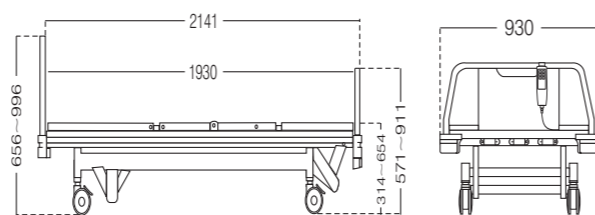

- W=930 mm, D=2141 mm, H=656-996 mm
- Frame material : Steel
- Frame finishing : Powder coating
- Frame color : Beige

Standar Pengoperasian Remote



1. 
Untuk mengatur posisi Hi-Lo Back Rest

2. 
Untuk mengatur posisi Hi-Lo Foot Rest

3. 
Untuk mengatur posisi Hi-Lo Bed

1.  Untuk mengatur posisi Hi-Lo Back Rest

2.  Untuk mengatur posisi Hi-Lo Foot Rest

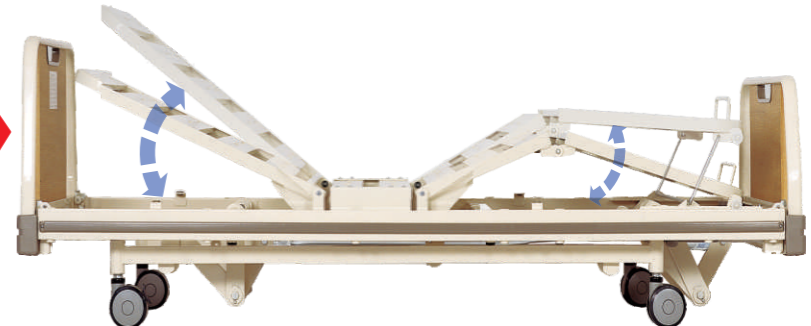

3.  Untuk mengatur posisi Hi-Lo Bed

