

Chitose®
Innovation by your inspiration

Chitose®
Innovation by your inspiration

2021 CATALOGUE



2021 PRODUCT CATALOGUE



PT Chitose Internasional, Tbk

Factory and Head Office

Jl Industri III no 5 Utama Cimahi 40533, INDONESIA
telp. +62 22 603 1900 | fax. +62 22 603 1855

Showroom, Marketing Office & Distribution Center

Jl HMS Mintareja Baros, Cimahi 40521, INDONESIA
telp. +62 22 2066 4777 | fax. +62 22 604 1900



Chitose mobile app :

www.chitose-indonesia.com

[f PT Chitose Internasional tbk](https://www.facebook.com/PTChitoseInternasional)

[@ptchitose](https://twitter.com/@ptchitose)

[chitoseinternasional](https://www.instagram.com/chitoseinternasional)

[Available on the App Store](https://www.apple.com/app-store)

[Get it on Google play](https://play.google.com/store/apps/details?id=com.chitose)



Innovation by your Inspiration



PT Chitose Internasional Tbk stands for innovations that are inspired by the users. We are driven by research and development, focusing on the growing need of furniture of Indonesia, yet also catering to demands from various parts of the world. Working in a simple and clean way, borderless, fair and decent, we strive to create a better life for all.

PT Chitose Internasional Tbk dengan bangga menghadirkan produk berkualitas hasil inovasi yang terinspirasi dari para penggunanya. Kami berkembang melalui riset yang tiada henti untuk memenuhi kebutuhan furnitur yang terus meningkat, baik dalam maupun di luar negeri. Dengan filosofi kerja "jujur, bersih, dan tanpa batas" kami berupaya menciptakan kesejahteraan bagi semua.

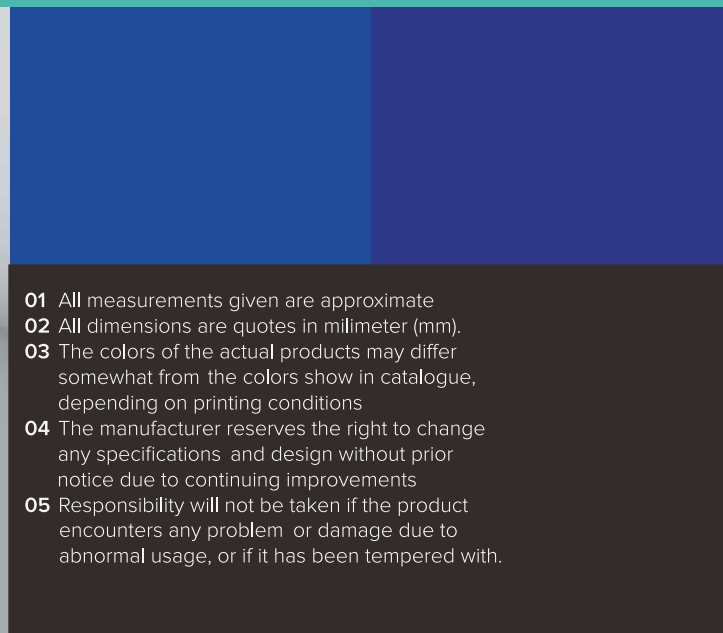

- 01 All measurements given are approximate
- 02 All dimensions are quotes in millimeter (mm).
- 03 The colors of the actual products may differ somewhat from the colors show in catalogue, depending on printing conditions
- 04 The manufacturer reserves the right to change any specifications and design without prior notice due to continuing improvements
- 05 Responsibility will not be taken if the product encounters any problem or damage due to abnormal usage, or if it has been tempered with.

Cetakan Pertama,
April 2021

Chitose[®]
Innovation by your inspiration



FOLDING CHAIR



MEMO CHAIR



SCHOOL CHAIR



**HOTEL BANQUET
AND RESTO**



WORKING MEETING



Folding chair 05

Yamato HAA/HNN	09
Yamato AA/NN	09
Cosmo-541/542	10
Cosmo-941/942	10
Daishogun	11
CAL	12
Yasuka Sliding	12



**Memo chair
and memo 13**

Yamato MND /MBD	17
Yamato MND/MBD plus	17
Cosmo MNR/MPR	18
Cosmo MNR/MPR plus	18
Daishogun LMUP	19
Cosmo LMPR	19
Olive A-LM	20



School chair 21

Echool-JP	25
Echool	26
Echool-Plus	27
Echool-HD	28
Manabu P-JP/P	29
Manabu P-Plus	30
Manabu P-HD	31
Keiko-JP/ Keiko	32
Keiko-FB	33
Keiko-FB HD	34
Keiko-Plus	35

Ayumi	36
Ayumi-HD	37
Manabu-AH 01	38
Manabu-AH 01 HD	39
Manabu-AH 02	40
Uni Desk & Chair	41
Shiro WS-1224	42
Shiro WS-1218	42
Shiro W-1224	42
Shiro W-1218	42
Colour Box 89	42
Colour Box 35 D	42
Colour Box 35 S	42
Colour Box 35	42



**Hotel banquet
and resto chair 43**

Taro-S	47
Hanako-S	47
Jiro-S	48
Caesar-N/P	48
Prince-N/P	49
Sakata-N/P	49
Callisto-N/P	50
Cavis	50
Olive-A	51
Olive-U	51
Sankei C-395	52
Glory	52
SAMM	53
Flora-H	53
Flora-San	54
Ribbon-P	54



Hotel banquet and resto table 55

Hobby Table T-1010	57
Table T-1010	57
Table T-7575	58
Coffee Table R-75	58
Coffee Table T-60	59
Coffee Table T-60 NE	59
Coffee Table T-60 PL	60
Coffee Table T-60 Kotatsu	60
Table T-6012 Kotatsu	61
FTC-6012	61
FTC-6012 NE	62
FTC-6018	62



Office chair 63

Duo-01	67
Duo-02	67
Fitto-SW	68
Fitto-FL	69
Fitto FL-R	70



Meeting chair 71

Costa	73
Ollive-SC	73
Olive-DX	74
Fronty	74
Duo-03	75
Duo-04	75

NEO	76
Jasmine C-111	77
Jasmine C-211	77
Cozy	78
Lotus	78
Fitto-ST	79
Kasai	80
Vista-N/P	80



Desk and table 81

TU-7014	83
TU-6012	83
TU-6012 Low	84
TU-7575 P	84
T-5512	85
T-7014 L/R	85
T-7014	86
T-7012	86
HTU-6014	87
CHIBA Desk-7014	87
Kumi-MT	88
Kumi-WS	89
Kumi-ED	90
Kumi-MD	90
Kumi-SD	91
Kumi-FD	91
Kumi-AST	92
Kumi Wagon-2D & 3D	92



Rack and storage 93

CHIBA SC-201	95
CHIBA SC-202	95
CHIBA SD-203	96
CHIBA SD-204	96
CHIBA SD/G-206	97
CHIBA SD/G-207	97
FC-113	98
FC-114	98
CHIBA MF/6-18	99
CHIBA MF/8-18	99
CHIBA MF/AUM/203	100
CHIBA MF/AUM/204	100
Locker	101
CK-810 & CK-1800	101
Maple Rack	102
Grey Rack	103
Executive Rack	104



Lobby space 105

Fuji-SS	107
Fuji-DS	107
Aso-SS	108
Aso-DS	108
KT-01 Cavis	109
KT-02 Cavis	109
KT-02 Olive	110
ATC-01	110

Kogu KT-03	111
Kogu-PC	111
Kogu-TS	112



Accessories 113

TM-01	114
TM-02	114
TF-01	114
TF-02	114
Colour Sample	115
Quality Assurance	117
Index	119
Company Highlights	121

Folding Chair

Technology makes more simple shapes, effectiveness, clean, practical, foldable, stackable and usable to fulfill all needs of function and situation.



REDEFINING QUALITY





YAMATO-HAA/HNN



YAMATO-AA/NN



COSMO-541/542



COSMO-941/942



DAISHOGUN



CAL



YASUKA SLIDING

YAMATO-HAA/HNN

PRODUCT SPECIFICATIONS

Dimension W x D x H (mm) : 449 x 518 x 813
 Weight per Piece (Kg) : 4.6
 Contain per Carton : 5
 Frame Finishing : Powder Coating (HAA)
 Chrome Plating (HNN)
 (HNN Seat Plate)

PRODUCT DIMENSION

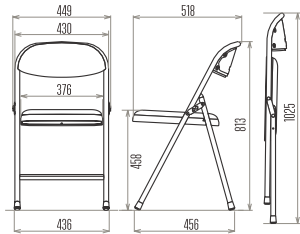

YAMATO HNN



YAMATO HAA

COLOUR OPTIONS & UPHOLSTERY MATERIAL

PVC Vinyl

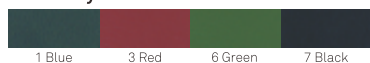

YAMATO-AA/NN

PRODUCT SPECIFICATIONS

Dimension W x D x H (mm) : 449 x 513 x 823
 Weight per Piece (Kg) : 4.6 (AA) ; 4,8 (NN)
 Contain per Carton : 5
 Frame Finishing : Chrome Plating (AA)
 Powder Coating (NN)
 (NN Seat Plate)

PRODUCT DIMENSION

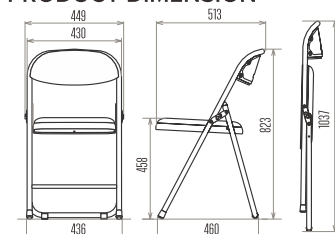

YAMATO NN



YAMATO NN

YAMATO AA

COLOUR OPTIONS & UPHOLSTERY MATERIAL

PVC Vinyl

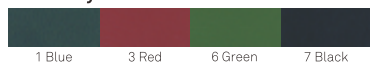

COSMO-541



COSMO-542

COSMO-541/542

PRODUCT SPECIFICATIONS

Dimension W x D x H (mm) : 460 x 446 x 773
 Weight per Piece (Kg) : 4.4
 Contain per Carton : 5
 Frame Finishing : Powder Coating (542)
 Chrome Plating (541)
 Frame Colour : Chrome Plating (541)

PRODUCT DIMENSION

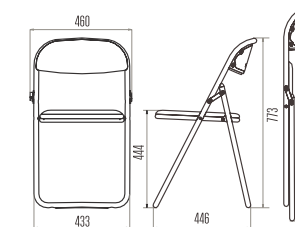

COLOUR OPTIONS & UPHOLSTERY MATERIAL

PVC Vinyl



Oscar



COSMO-941/942

PRODUCT SPECIFICATIONS

Dimension W x D x H (mm) : 490 x 449 x 778
 Weight per Piece (Kg) : 4.8
 Contain per Carton : 5
 Frame Finishing : Nickel Chrome (941)
 Powder Coating (942)
 Frame Colour : Chrome (941), Silver (942)

PRODUCT DIMENSION

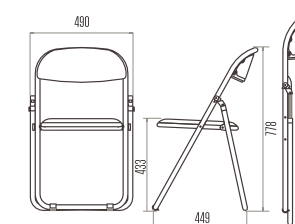

Cosmo-941



Cosmo-942

Cosmo-941

COLOUR OPTIONS & UPHOLSTERY MATERIAL

PVC Vinyl



Oscar



DAISHOGUN

PRODUCT SPECIFICATIONS

Dimension W x D x H (mm) : 449 x 493 x 807
 Weight per Piece (Kg) : 4.4
 Contain per Carton : 4
 Frame Finishing : Powder Coating
 Frame Colour : Light Grey

PRODUCT DIMENSION

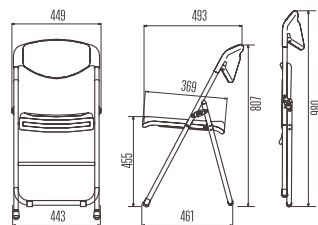

COLOUR OPTIONS & UPHOLSTERY MATERIAL

Oscar

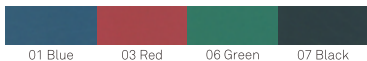

CAL (CHITOSE ALUMINIUM)

PRODUCT SPECIFICATIONS

Dimension W x D x H (mm) : 450 x 495 x 783
 Weight per Piece (Kg) : 4.1
 Contain per Carton : 4
 Frame Finishing : Powder Coating
 Frame Colour : Silver

PRODUCT DIMENSION

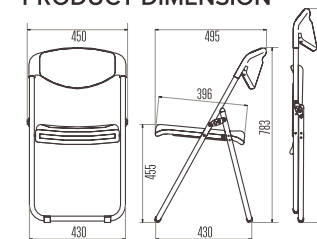

COLOUR OPTIONS & UPHOLSTERY MATERIAL

Fabric



YASUKA SLIDING

PRODUCT SPECIFICATIONS

Dimension W x D x H (mm) : 417 x 434 x 744
 Weight per Piece (Kg) : 3.9
 Contain per Carton : 6
 Frame Finishing : Chrome Plating
 Frame Colour : Chrome

PRODUCT DIMENSION

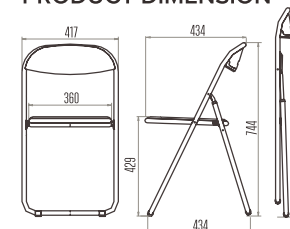

COLOUR OPTIONS & UPHOLSTERY MATERIAL

PVC Vinyl



Memo Chair

Technology makes more simple shapes, effectiveness, clean, practical, foldable, stackable and usable to fulfill all needs of function and situation.



DELICATE CREATION





YAMATO-MND



YAMATO-MBD



YAMATO-MND PLUS



YAMATO-MBD PLUS



COSMO-MNR



COSMO-MPR



COSMO-MNR PLUS



COSMO-MPR PLUS



DISHOGUN-LMUP



COSMO-LMPR



OLIVE-ALM

COSMO-MNR/MPR PLUS

PRODUCT SPECIFICATIONS

Dimension W x D x H (mm) : 471 x 714 x 771
 Weight per Piece (Kg) : 6.0
 Contain per Carton : 2
 Memo Table Material : Plastic
 Frame Finishing : Chrome Plating (MNR Plus)
 Powder Coating (MPR Plus)
 Frame Colour : Chrome, Silver

PRODUCT DIMENSION

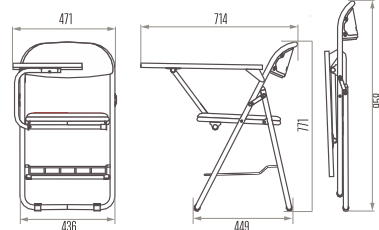

COLOUR OPTIONS & UPHOLSTERY MATERIAL

PVC



Plastic



Memo Table
Made of High
Quality Plastic



DAISHOGUN-LMUP

PRODUCT SPECIFICATIONS

Dimension W x D x H (mm) : 430 x 456 x 809
 Weight per Piece (Kg) : 7.4
 Contain per Carton : 2
 Memo Table Material : Plywood
 Frame Finishing : Powder Coating
 Frame Colour : Grey

PRODUCT DIMENSION

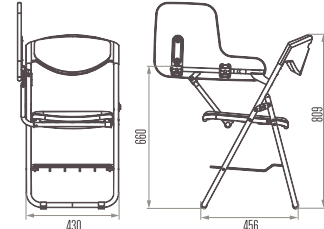

COLOUR OPTIONS & UPHOLSTERY MATERIAL

Oscar

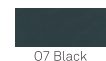

COSMO-LMPR

PRODUCT SPECIFICATIONS

Dimension W x D x H (mm) : 430 x 456 x 814
 Weight per Piece (Kg) : 7.1
 Contain per Carton : 2
 Memo Table Material : Plywood
 Frame Finishing : Powder Coating
 Frame Colour : Silver

PRODUCT DIMENSION

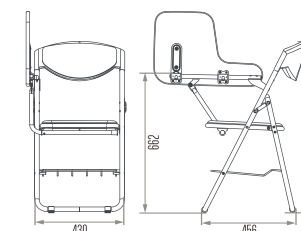

COLOUR OPTIONS & UPHOLSTERY MATERIAL

PVC

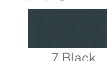

OLIVE-ALM

PRODUCT SPECIFICATIONS

Dimension W x D x H (mm) : 511 x 582 x 795
 Weight per Piece (Kg) : 4.9
 Contain per Carton : 4
 Memo Table Material : Plywood
 Frame Finishing : Silver
 Frame Colour : Powder Coating

PRODUCT DIMENSION

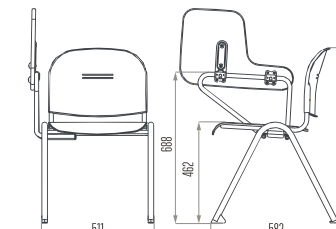

SEAT-BACK MATERIAL & COLOURS

Plastic



School Chair

Fulfill your knowledge by learning, study, research for an innovation and supported by ergonomist furniture.



ENJOYABLE LESSON





ECHOOL-JP



ECHOOL



ECHOOL-PLUS



ECHOOL-HD



MANABU-P JP/P



MANABU-P PLUS



MANABU P-HD



KEIKO-JP/KEIKO



KEIKO-FB



KEIKO-FB HD



KEIKO PLUS



AYUMI



AYUMI-HD



MANABU-AH 01



MANABU-AH 01 HD



MANABU-AH 02



UNI DESK & UNI CHAIR



SHIRO WS-1224/1218
SHIRO 1224/1218



COLOUR BOX

ECHOOL-JP



PRODUCT SPECIFICATIONS

Table
Dimension W x D x H (mm) : 650 x 450 x 525 (No.2)
650 x 450 x 585 (No.3)
650 x 450 x 645 (No.4)
650 x 450 x 705 (No.5)
650 x 450 x 765 (No.6)
Weight per Piece (Kg) : 6.4 / 6.6 / 6.8 / 7.0 / 7.15
Contain per Carton : 4
Table Top Material : Plywood
Drawer Material : Plastic
Frame Finishing : Powder Coating
Frame Colour : Ivory

Chair
Dimension W x D x H (mm) : 420 x 362 x 570 (No.2)
420 x 368 x 640 (No.3)
420 x 394 x 685 (No.4)
420 x 420 x 740 (No.5)
420 x 441 x 830 (No.6)
Weight per Piece (Kg) : 3.3 / 3.5 / 3.6 / 3.8 / 4.3
Contain per Carton : 4
Frame Colour : Ivory
Seat & Back Material : Plywood
Frame Finishing : Powder Coating

PRODUCT DIMENSION

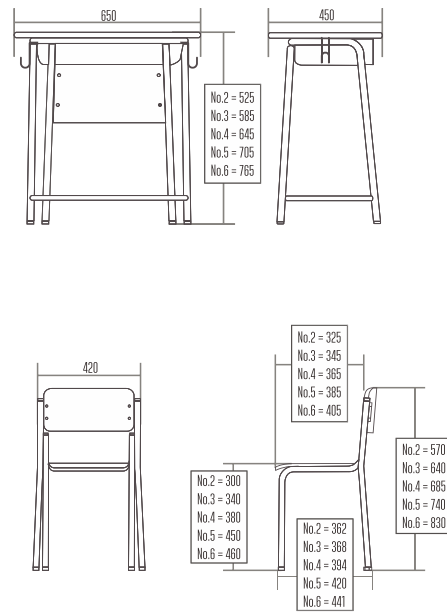

Table Height	Person Height	Range Height
525 mm	120 cm	113-126 cm
585 mm	135 cm	127-141 cm
645 mm	150 cm	142-156 cm
705 mm	165 cm	157-172 cm
765 mm	180 cm	173-180 cm

ECHOOL



PRODUCT SPECIFICATIONS

Table
Dimension W x D x H (mm) : 650 x 450 x 525 (No.2)
650 x 450 x 585 (No.3)
650 x 450 x 645 (No.4)
650 x 450 x 705 (No.5)
650 x 450 x 765 (No.6)
Weight per Piece (Kg) : 6.4 / 6.6 / 6.8 / 7.0 / 7.15
Contain per Carton : 4
Table Top Material : Plywood
Drawer Material : Plastic
Frame Finishing : Powder Coating
Frame Colour : Ivory

Chair
Dimension W x D x H (mm) : 420 x 362 x 570 (No.2)
420 x 368 x 640 (No.3)
420 x 394 x 685 (No.4)
420 x 420 x 740 (No.5)
420 x 441 x 830 (No.6)
Weight per Piece (Kg) : 3.3 / 3.5 / 3.6 / 3.8 / 4.3
Contain per Carton : 4
Frame Colour : Ivory
Seat & Back Material : Plywood
Frame Finishing : Powder Coating

PRODUCT DIMENSION

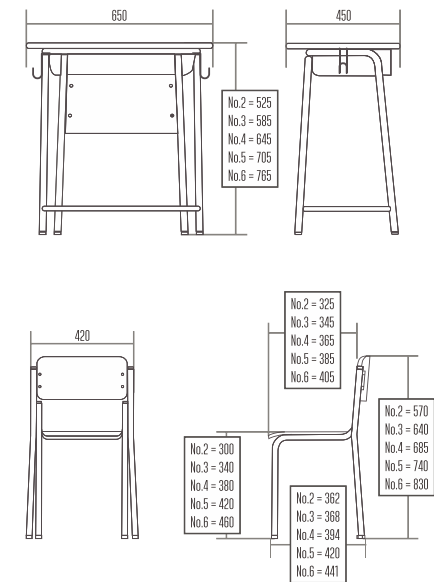

Table Height	Person Height	Range Height
525 mm	120 cm	113-126 cm
585 mm	135 cm	127-141 cm
645 mm	150 cm	142-156 cm
705 mm	165 cm	157-172 cm
765 mm	180 cm	173-180 cm

ECHOOL-PLUS



PRODUCT SPECIFICATIONS

Table
Dimension W x D x H (mm) : 650 x 450 x 535 (No.2)
650 x 450 x 595 (No.3)
650 x 450 x 655 (No.4)
650 x 450 x 715 (No.5)
650 x 450 x 775 (No.6)

Weight per Piece (Kg) : 3.8 / 3.9 / 4.0 / 4.2 / 4.3
Contain per Carton : 4
Table Top Material : Plastic
Drawer Material : Plastic
Front Board Material : Plastic
Frame Finishing : Powder Coating
Frame Colour : Ivory

Chair
Dimension W x D x H (mm) : 420 x 362 x 570 (No.2)
420 x 368 x 640 (No.3)
420 x 394 x 685 (No.4)
420 x 420 x 740 (No.5)
420 x 441 x 830 (No.6)

Weight per Piece (Kg) : 3.3 / 3.5 / 3.6 / 3.8 / 4.3
Contain per Carton : 4
Frame Colour : Ivory
Seat & Back Material : Plastic
Frame Finishing : Powder Coating

PRODUCT DIMENSION

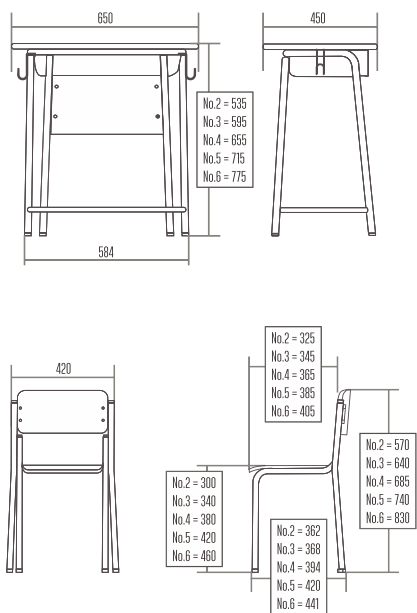

Table Height	Person Height	Range Height
535 mm	120 cm	113-126 cm
595 mm	135 cm	127-141 cm
655 mm	150 cm	142-156 cm
715 mm	165 cm	157-172 cm
775 mm	180 cm	173-180 cm

ECHOOL-HD



PRODUCT SPECIFICATIONS

Table
Dimension W x D x H (mm) : 700 x 500 x 525 (No.2)
700 x 500 x 585 (No.3)
700 x 500 x 645 (No.4)
700 x 500 x 705 (No.5)
700 x 500 x 765 (No.6)

Weight per Piece (Kg) : - / - / - / - / -
Contain per Carton : 4
Table Top Material : Plywood
Drawer Material : Plastic
Frame Finishing : Powder Coating
Frame Colour : Ivory

Chair
Dimension W x D x H (mm) : 420 x 362 x 570 (No.2)
420 x 368 x 640 (No.3)
420 x 394 x 685 (No.4)
420 x 420 x 740 (No.5)
420 x 441 x 830 (No.6)

Weight per Piece (Kg) : 3.3 / 3.5 / 3.6 / 3.8 / 4.3
Contain per Carton : 4
Frame Colour : Ivory
Seat & Back Material : Plywood
Frame Finishing : Powder Coating

PRODUCT DIMENSION

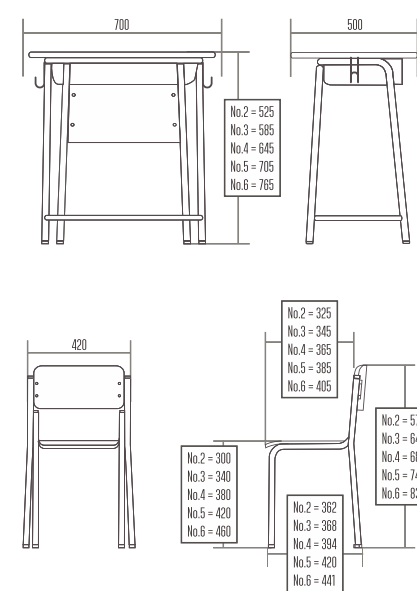





Table Height	Person Height	Range Height
525 mm	120 cm	113-126 cm
585 mm	135 cm	127-141 cm
645 mm	150 cm	142-156 cm
705 mm	165 cm	157-172 cm
765 mm	180 cm	173-180 cm

MANABU-P JP/P



4  142-156 cm
5  157-172 cm
6  173-180 cm



4  5  6 

PRODUCT SPECIFICATIONS

Table
Dimension W x D x H (mm) : 650 x 450 x 640 (No.4)
650 x 450 x 700 (No.5)
650 x 450 x 760 (No.6)
Weight per Piece (Kg) : 8.4 / 8.5 / 8.57
Contain per Carton : 4
Table Top Material : Plywood
Drawer Material : Astal
Frame Finishing : Powder Coating
Frame Colour : Ivory

Chair
Dimension W x D x H (mm) : 462 x 465 x 750 (No.4)
462 x 465 x 790 (No.5)
462 x 465 x 830 (No.6)
Weight per Piece (Kg) : 3.0 / 3.6 / 4.2
Contain per Carton : 4
Frame Colour : Ivory
Seat & Back Material : Plastic
Frame Finishing : Powder Coating

SEAT-BACK MATERIAL & COLOURS

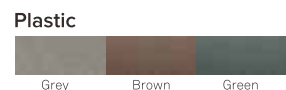

PRODUCT DIMENSION

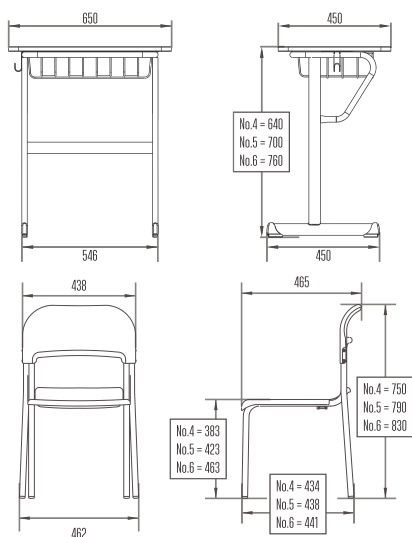





Table Height	Person Height	Range Height
640 mm	150 cm	142-156 cm
700 mm	165 cm	157-172 cm
760 mm	180 cm	173-180 cm

MANABU-P PLUS



4  142-156 cm
5  157-172 cm
6  173-180 cm



4  5  6 

PRODUCT SPECIFICATIONS

Table
Dimension W x D x H (mm) : 650 x 450 x 651 (No.4)
650 x 450 x 711 (No.5)
650 x 450 x 771 (No.6)
Weight per Piece (Kg) : 8.4 / 8.53 / 8.57
Contain per Carton : 4
Table Top Material : Plastic
Drawer Material : Astal
Frame Finishing : Powder Coating
Frame Colour : Ivory

Chair
Dimension W x D x H (mm) : 462 x 465 x 750 (No.4)
462 x 465 x 790 (No.5)
462 x 465 x 830 (No.6)
Weight per Piece (Kg) : 3.0 / 3.6 / 4.2
Contain per Carton : 4
Frame Colour : Ivory
Seat & Back Material : Plastic
Frame Finishing : Powder Coating

SEAT-BACK MATERIAL & COLOURS



PRODUCT DIMENSION

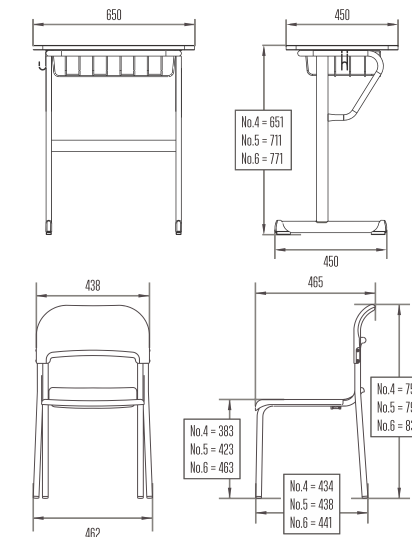

Table Height	Person Height	Range Height
651 mm	150 cm	142-156 cm
711 mm	165 cm	157-172 cm
771 mm	180 cm	173-180 cm

MANABU P-HD



- 4 ■ 142-156 cm
- 5 ■ 157-172 cm
- 6 ■ 173-180 cm

4 ■

5 ■

6 ■

PRODUCT SPECIFICATIONS

Table

Dimension W x D x H (mm) : 700 x 500 x 640 (No.4)
700 x 500 x 700 (No.5)
700 x 500 x 760 (No.6)

Weight per Piece (Kg) : - / - / -

Contain per Carton : 4

Table Top Material : Plywood

Drawer Material : Astal

Frame Finishing : Powder Coating

Frame Colour : Ivory

Chair

Dimension W x D x H (mm) : 462 x 465 x 750 (No.4)
462 x 465 x 790 (No.5)
462 x 465 x 830 (No.6)

Weight per Piece (Kg) : 3.0 / 3.6 / 4.2

Contain per Carton : 4

Frame Colour : Ivory

Seat & Back Material : Plastic

Frame Finishing : Powder Coating

PRODUCT DIMENSION

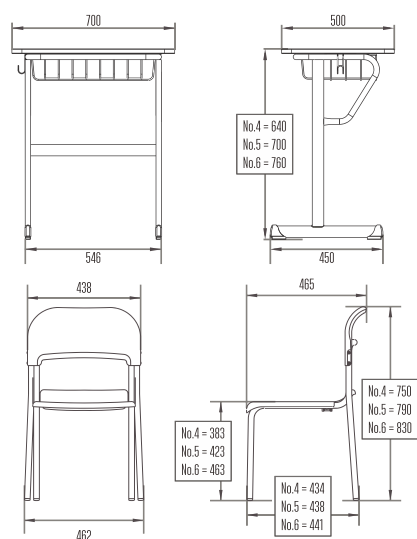

Table Height	Person Height	Range Height
640 mm	150 cm	142-156 cm
700 mm	165 cm	157-172 cm
760 mm	180 cm	173-180 cm

SEAT-BACK MATERIAL & COLOURS

Plastic



KEIKO-JP / KEIKO



- 4 ■ 142-156 cm
- 5 ■ 157-172 cm
- 6 ■ 173-180 cm

4 ■

5 ■

6 ■

PRODUCT SPECIFICATIONS

Table

Dimension W x D x H (mm) : 650 x 450 x 640 (No.4)
650 x 450 x 700 (No.5)
650 x 450 x 760 (No.6)

Weight per Piece (Kg) : 7.59 / 7.63 / 7.67

Contain per Carton : 4

Table Top Material : Plywood

Drawer Material : Astal

Frame Finishing : Powder Coating

Frame Colour : Ivory

Chair

Dimension W x D x H (mm) : 462 x 465 x 750 (No.4)
462 x 465 x 790 (No.5)
462 x 465 x 830 (No.6)

Weight per Piece (Kg) : 3.0 / 3.6 / 4.2

Contain per Carton : 4

Frame Colour : Ivory

Seat & Back Material : Plastic

Frame Finishing : Powder Coating

PRODUCT DIMENSION

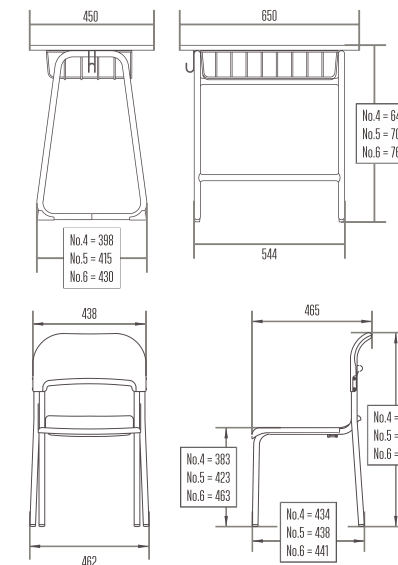

Table Height	Person Height	Range Height
640 mm	150 cm	142-156 cm
700 mm	165 cm	157-172 cm
760 mm	180 cm	173-180 cm

SEAT-BACK MATERIAL & COLOURS

Plastic



KEIKO-FB



- 4 ■ 142-156 cm
- 5 ■ 157-172 cm
- 6 ■ 173-180 cm



PRODUCT SPECIFICATIONS

Table
Dimension W x D x H (mm) : 650 x 450 x 640 (No.4)
650 x 450 x 700 (No.5)
650 x 450 x 760 (No.6)
Weight per Piece (Kg) : 8.0 / 8.15 / 8.3
Contain per Carton : 4
Table Top Material : Plywood
Drawer Material : Astal
Frame Finishing : Powder Coating
Frame Colour : Ivory

Chair
Dimension W x D x H (mm) : 462 x 465 x 750 (No.4)
462 x 465 x 790 (No.5)
462 x 465 x 830 (No.6)
Weight per Piece (Kg) : 3.0 / 3.6 / 4.2
Contain per Carton : 4
Frame Colour : Ivory
Seat & Back Material : Plastic
Frame Finishing : Powder Coating

SEAT-BACK MATERIAL & COLOURS

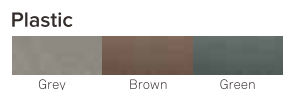

PRODUCT DIMENSION

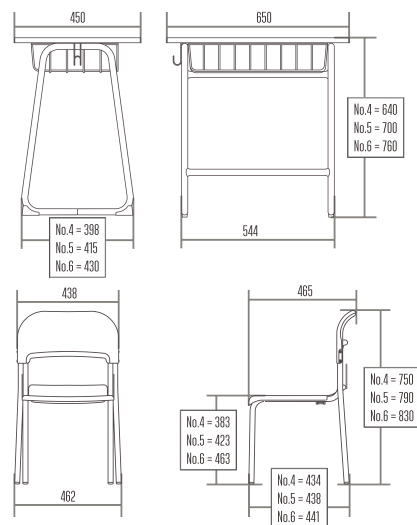

Table Height	Person Height	Range Height
640 mm	150 cm	142-156 cm
700 mm	165 cm	157-172 cm
760 mm	180 cm	173-180 cm

KEIKO-FB HD



- 4 ■ 142-156 cm
- 5 ■ 157-172 cm
- 6 ■ 173-180 cm



PRODUCT SPECIFICATIONS

Table
Dimension W x D x H (mm) : 700 x 500 x 640 (No.4)
700 x 500 x 700 (No.5)
700 x 500 x 760 (No.6)
Weight per Piece (Kg) : - / - / -
Contain per Carton : 4
Table Top Material : Plywood
Drawer Material : Astal
Frame Finishing : Powder Coating
Frame Colour : Ivory

Chair
Dimension W x D x H (mm) : 462 x 465 x 750 (No.4)
462 x 465 x 790 (No.5)
462 x 465 x 830 (No.6)
Weight per Piece (Kg) : 3.0 / 3.6 / 4.2
Contain per Carton : 4
Frame Colour : Ivory
Seat & Back Material : Plastic
Frame Finishing : Powder Coating

SEAT-BACK MATERIAL & COLOURS

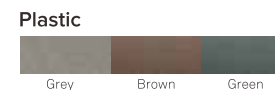

PRODUCT DIMENSION

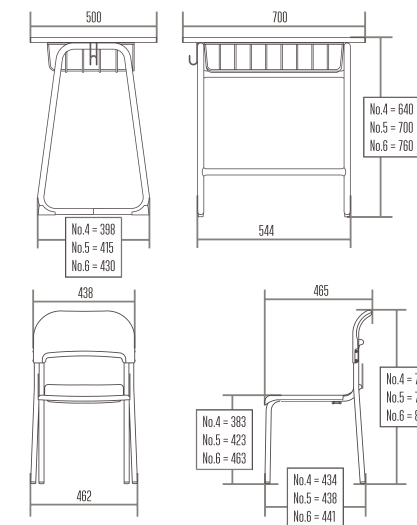

Table Height	Person Height	Range Height
640 mm	150 cm	142-156 cm
700 mm	165 cm	157-172 cm
760 mm	180 cm	173-180 cm

KEIKO-PLUS



- 4 ■ 142-156 cm
- 5 ■ 157-172 cm
- 6 ■ 173-180 cm



- 4 ■
- 5 ■
- 6 ■

PRODUCT SPECIFICATIONS

Table
Dimension W x D x H (mm) : 650 x 450 x 646 (No.4)
650 x 450 x 706 (No.5)
650 x 450 x 766 (No.6)
Weight per Piece (Kg) : 7.59 / 7.63 / 7.67
Contain per Carton : 4
Table Top Material : Plastic
Drawer Material : Astral
Frame Finishing : Powder Coating
Frame Colour : Ivory

Chair
Dimension W x D x H (mm) : 462 x 465 x 750 (No.4)
462 x 465 x 790 (No.5)
462 x 465 x 830 (No.6)
Weight per Piece (Kg) : 3.0 / 3.6 / 4.2
Contain per Carton : 4
Frame Colour : Ivory
Seat & Back Material : Plastic
Frame Finishing : Powder Coating

PRODUCT DIMENSION

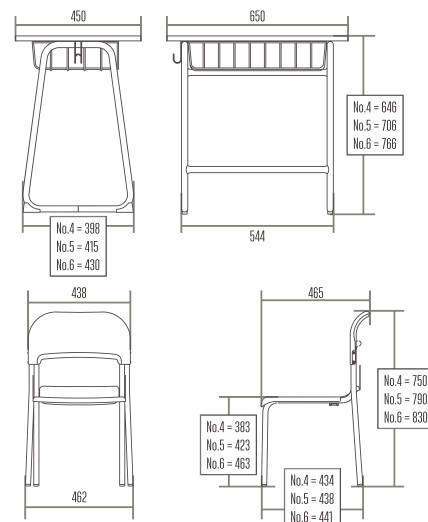

Table Height	Person Height	Range Height
646 mm	150 cm	142-156 cm
706 mm	165 cm	157-172 cm
766 mm	180 cm	173-180 cm

SEAT-BACK MATERIAL & COLOURS



AYUMI



- 4 ■ 142-156 cm
- 5 ■ 157-172 cm
- 6 ■ 173-180 cm



- 4 ■
- 5 ■
- 6 ■

PRODUCT SPECIFICATIONS

Table
Dimension W x D x H (mm) : 648 x 498 x 640 (No.4)
648 x 519 x 700 (No.5)
648 x 540 x 760 (No.6)
Weight per Piece (Kg) : 6.43 / 6.47 / 6.74
Contain per Carton : 4
Frame Finishing : Particle Board
Frame Finishing : Powder Coating
Frame Colour : Ivory

Chair
Dimension W x D x H (mm) : 495 x 403 x 690 (No.4)
495 x 448 x 730 (No.5)
495 x 463 x 770 (No.6)
Weight per Piece (Kg) : 3.2 / 3.27 / 3.36
Contain per Carton : 4
Frame Colour : Ivory
Seat & Back Material : Plastic
Frame Finishing : Powder Coating

PRODUCT DIMENSION

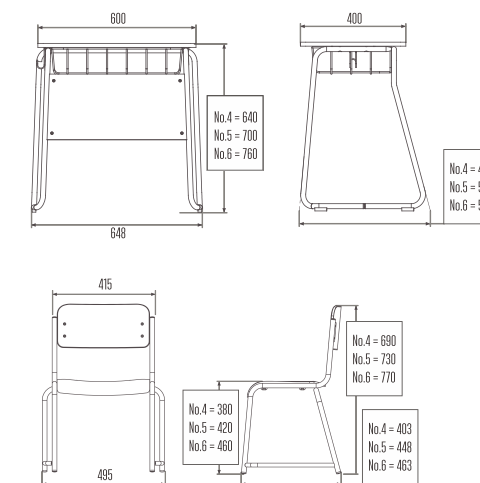

Table Height	Person Height	Range Height
640 mm	150 cm	142-156 cm
700 mm	165 cm	157-172 cm
760 mm	180 cm	173-180 cm

SEAT-BACK MATERIAL & COLOURS



AYUMI-HD



4 142-156 cm

5 157-172 cm

6 173-180 cm



PRODUCT SPECIFICATIONS

Table
Dimension W x D x H (mm) : 700 x 500 x 640 (No.4)
700 x 519 x 700 (No.5)
700 x 540 x 760 (No.6)
Weight per Piece (Kg) : - / - / -
Contain per Carton : 4
Table Top Material : Plywood
Frame Finishing : Powder Coating
Frame Colour : Ivory

PRODUCT DIMENSION

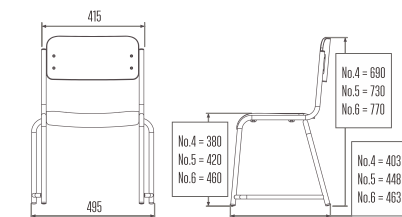
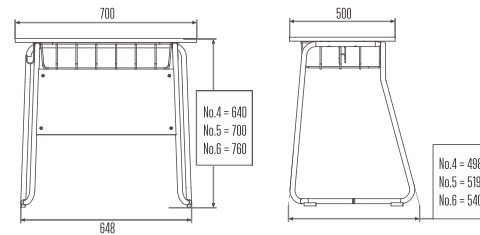

Chair
Dimension W x D x H (mm) : 495 x 403 x 690 (No.4)
495 x 448 x 730 (No.5)
495 x 463 x 770 (No.6)
Weight per Piece (Kg) : 3.2 / 3.27 / 3.36
Contain per Carton : 4
Frame Colour : Ivory
Seat & Back Material : Plywood
Frame Finishing : Powder Coating

SEAT-BACK MATERIAL & COLOURS

Plastic



Brown

Table Height	Person Height	Range Height
640 mm	150 cm	142-156 cm
700 mm	165 cm	157-172 cm
760 mm	180 cm	173-180 cm

MANABU-AH 01



3 127-141 cm

4 142-156 cm

5 157-172 cm

6 173-180 cm

Chair & Table : Adjustable High Level

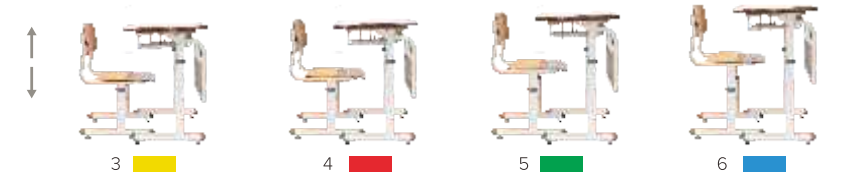

PRODUCT SPECIFICATIONS

Table
Dimension W x D x H (mm) : 650 x 450 x 580 (No.3)
650 x 450 x 640 (No.4)
650 x 450 x 700 (No.5)
650 x 450 x 760 (No.6)
Weight per Piece (Kg) : 11
Contain per Carton : 4
Table Top Material : Plywood
Frame Finishing : Powder Coating
Frame Colour : Ivory

PRODUCT DIMENSION

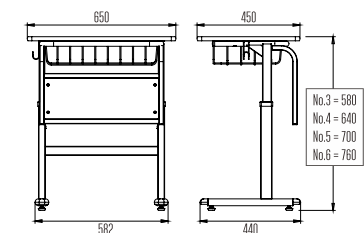

Chair
Dimension W x D x H (mm) : 398 x 440 x 650 (No.3)
398 x 440 x 690 (No.4)
398 x 440 x 730 (No.5)
398 x 440 x 770 (No.6)
Weight per Piece (Kg) : 6.7
Contain per Carton : 4
Frame Colour : Ivory
Seat & Back Material : Plywood
Frame Finishing : Powder Coating

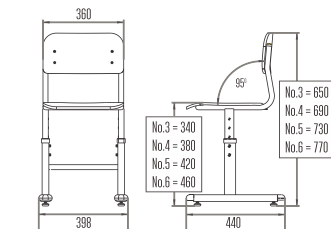

Table Height	Person Height	Range Height
580 mm	135 cm	127-141 cm
640 mm	150 cm	142-156 cm
700 mm	165 cm	157-172 cm
760 mm	180 cm	173-180 cm

MANABU-AH 01 HD



- 3 ■ 127-141 cm
- 4 ■ 142-156 cm
- 5 ■ 157-172 cm
- 6 ■ 173-180 cm

Chair & Table : Adjustable High Level

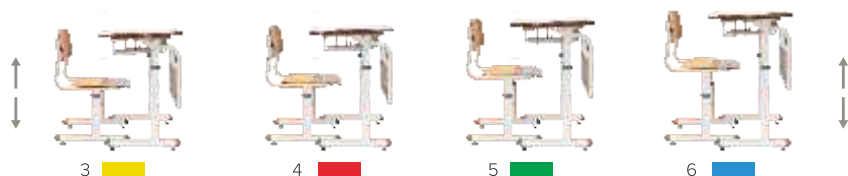

PRODUCT SPECIFICATIONS

Table
Dimension W x D x H (mm) : 700 x 500 x 580 (No.3)
700 x 500 x 640 (No.4)
700 x 500 x 700 (No.5)
700 x 500 x 760 (No.6)

Weight per Piece (Kg) : -
Contain per Carton : 4
Table Top Material : Plywood
Frame Finishing : Powder Coating
Frame Colour : Ivory

Chair
Dimension W x D x H (mm) : 398 x 440 x 650 (No.3)
398 x 440 x 690 (No.4)
398 x 440 x 730 (No.5)
398 x 440 x 770 (No.6)

Weight per Piece (Kg) : 6.7
Contain per Carton : 4
Frame Colour : Ivory
Seat & Back Material : Plywood
Frame Finishing : Powder Coating

PRODUCT DIMENSION

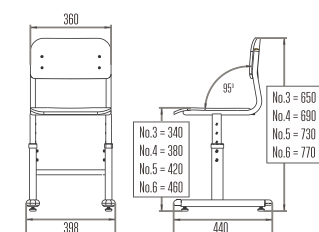
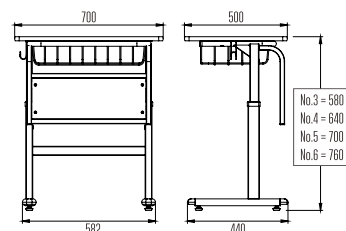

Table Height	Person Height	Range Height
580 mm	135 cm	127-141 cm
640 mm	150 cm	142-156 cm
700 mm	165 cm	157-172 cm
760 mm	180 cm	173-180 cm

MANABU-AH 02



- 3 ■ 127-141 cm
- 4 ■ 142-156 cm
- 5 ■ 157-172 cm
- 6 ■ 173-180 cm

Chair & Table : Adjustable High Level



PRODUCT SPECIFICATIONS

Table
Dimension W x D x H (mm) : 1200 x 450 x 580 (No.3)
1200 x 450 x 640 (No.4)
1200 x 450 x 700 (No.5)
1200 x 450 x 760 (No.6)

Weight per Piece (Kg) : 13.5
Contain per Carton : 4
Table Top Material : Plywood
Frame Finishing : Powder Coating
Frame Colour : Ivory

Chair
Dimension W x D x H (mm) : 398 x 440 x 650 (No.3)
398 x 440 x 690 (No.4)
398 x 440 x 730 (No.5)
398 x 440 x 770 (No.6)

Weight per Piece (Kg) : 6.7
Contain per Carton : 4
Frame Colour : Ivory
Seat & Back Material : Plywood
Frame Finishing : Powder Coating

PRODUCT DIMENSION

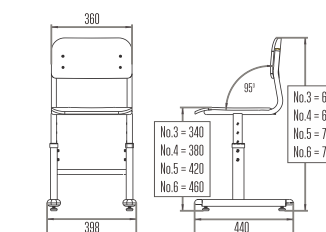
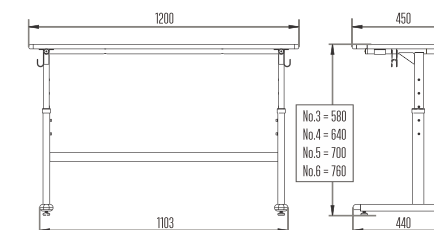

Table Height	Person Height	Range Height
580 mm	135 cm	127-141 cm
640 mm	150 cm	142-156 cm
700 mm	165 cm	157-172 cm
760 mm	180 cm	173-180 cm

UNI DESK & CHAIR (HIGH & LOW)



PRODUCT SPECIFICATIONS

Table
Dimension W x D x H (mm) : 1290 x 400 x 700 (High)
1290 x 400 x 600 (Low)
Weight per Piece (Kg) : 11.3 (High)/ 11.1 (Low)
Contain per Carton : 1
Table Top Material : Plywood
Frame Finishing : Powder Coating
Frame Colour : Ivory

PRODUCT DIMENSION

UNI DESK & CHAIR (High)

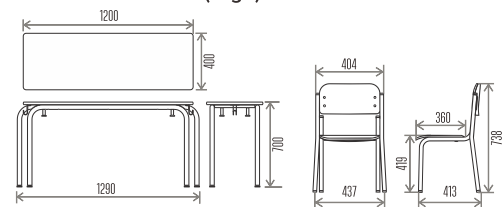

UNI DESK & CHAIR (Low)

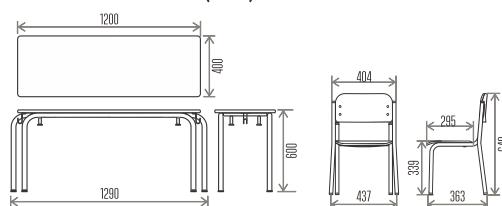

Chair
Dimension W x D x H (mm) : 437 x 413 x 738 (High)
437 x 363 x 640 (Low)
Contain per Carton : 4
Frame Colour : Ivory
Seat & Back Material : Plywood
Frame Finishing : Powder Coating

SHIRO WS-1224 / 1218 (WITH LEG)
SHIRO W-1224 / 1218 (WITHOUT LEG)



PRODUCT SPECIFICATIONS

Dimension W x D (mm) : 2400 x 1200 (WS-1224)
1800 x 1200 (WS-1218)
(Board Only)
Contain per Carton : 1
Frame Finishing : Powder Coating
Frame Colour : Black
Panel Board Material : Particle Board + Melamine

PRODUCT DIMENSION

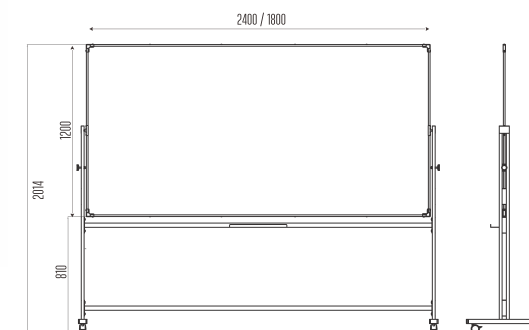

COLOUR BOX

PRODUCT SPECIFICATIONS

Dimension W x D x H (mm) : 350 x 292 x 350 (35, 35 S, 35 D)
420 x 290 x 890 (89)
Weight per Piece (Kg) : 3.6 / 4.4 / 4.4 / 8.8
Contain per Carton : 1
Panel Board Material : Particle Board



Colour Box 35 Colour Box 35 S Colour Box 35 D

PRODUCT DIMENSION

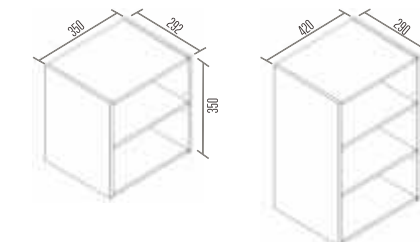

Colour Box 89

COLOUR OPTIONS & UPHOLSTERY MATERIAL

Particle Board with Back Panel MDF (35, 35 S, 35 D)



Particle Board with Back Panel MDF (89)



Hotel Banquet and Resto

Keep a relationship, partnership, family and new customer with a furniture that suite to their lifestyle.



CELEBRATING MOMENT





TARO-S



HANA-KO-S



JIRO-S



CAESAR-N/P



PRINCE-N/P



SAKATA-N/P



CALISTO-N/P



CAVIS



OLIVE-A



OLIVE-U



SANKEI C-395



GLORY



SAMM



FLORA-H



FLORA-SAN



RIBBON-P



TARO-S

PRODUCT SPECIFICATIONS

Dimension W x D x H (mm) : 455 x 554 x 890
 Weight per Piece (Kg) : 6.5
 Contain per Carton : 4
 Frame Colour : Silver, Gold, Cream
 Frame Finishing : Powder Coating

PRODUCT DIMENSION

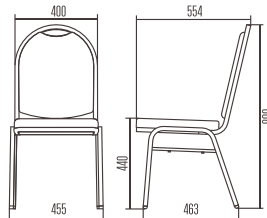

COLOUR OPTIONS & UPHOLSTERY MATERIAL

Fabric



JIRO-S

PRODUCT SPECIFICATIONS

Dimension W x D x H (mm) : 455 x 554 x 890
 Weight per Piece (Kg) : 6.5
 Contain per Carton : 4
 Frame Finishing : Silver, Gold, Cream
 Frame Colour : Powder Coating

PRODUCT DIMENSION

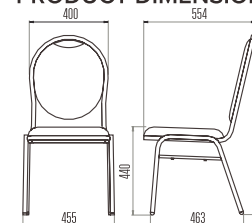

COLOUR OPTIONS & UPHOLSTERY MATERIAL

Fabric

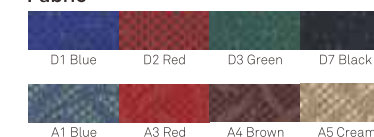

HANA-KO-S

PRODUCT SPECIFICATIONS

Dimension W x D x H (mm) : 455 x 555 x 890
 Weight per Piece (Kg) : 6.8
 Contain per Carton : 4
 Frame Colour : Silver, Gold, Cream
 Frame Finishing : Powder Coating

PRODUCT DIMENSION

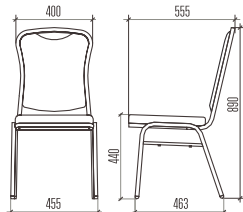

COLOUR OPTIONS & UPHOLSTERY MATERIAL

Fabric



CAESAR-N/P

PRODUCT SPECIFICATIONS

Dimension W x D x H (mm) : 419 x 530 x 868
 Weight per Piece (Kg) : 5.2
 Contain per Carton : 4
 Frame Finishing : Powder Coating (P)
 Chrome Plating (N)
 Frame Colour : Black, Silver
 Cushion : C-Pro

PRODUCT DIMENSION

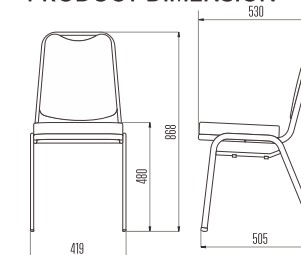

COLOUR OPTIONS & UPHOLSTERY MATERIAL

Fabric



PRINCE-N/P

PRODUCT SPECIFICATIONS

Dimension W x D x H (mm) : 456 x 585 x 896
 Weight per Piece (Kg) : 4.95
 Contain per Carton : 4
 Frame Colour : Chrome, Silver, Gold, Ivory, Black
 Frame Finishing : Chrome Plating (N)
 Powder Coating (P)

PRODUCT DIMENSION

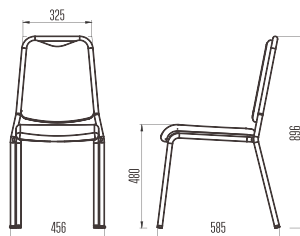

COLOUR OPTIONS & UPHOLSTERY MATERIAL

Fabric



SAKATA-N/P

PRODUCT SPECIFICATIONS

Dimension W x D x H (mm) : 435 x 512 x 895
 Weight per Piece (Kg) : 4.8
 Contain per Carton : 4
 Frame Colour : Chrome, Silver, Gold, Ivory, Black
 Frame Finishing : Chrome Plating (N)
 Powder Coating (P)

PRODUCT DIMENSION

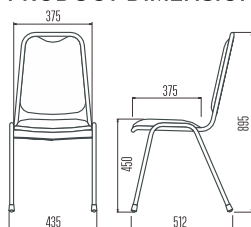

COLOUR OPTIONS & UPHOLSTERY MATERIAL

Fabric



CALLISTO-N/P

PRODUCT SPECIFICATIONS

Dimension W x D x H (mm) : 460 x 527 x 900
 Weight per Piece (Kg) : 6.31
 Contain per Carton : 2
 Frame Finishing : Chrome Plating (N)
 Powder Coating (P)
 Frame Colour : Chrome, Grey

PRODUCT DIMENSION

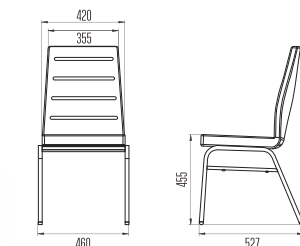

COLOUR OPTIONS & UPHOLSTERY MATERIAL

Fabric



CAVIS

PRODUCT SPECIFICATIONS

Dimension W x D x H (mm) : 476 x 507 x 780
 Weight per Piece (Kg) : 5.3
 Contain per Carton : 4
 Frame Finishing : Powder Coating
 Frame Colour : Light Grey, Ivory

PRODUCT DIMENSION

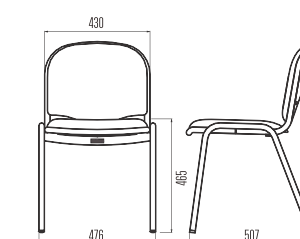

COLOUR OPTIONS & UPHOLSTERY MATERIAL

Fabric



OLIVE-A

PRODUCT SPECIFICATIONS

Dimension W x D x H (mm) : 515 x 585 x 795
 Weight per Piece (Kg) : 4.2
 Contain per Carton : 4
 Frame Colour : Silver
 Frame Finishing : Powder Coating

PRODUCT DIMENSION

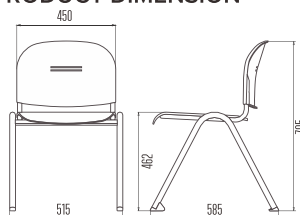

COLOUR OPTIONS & UPHOLSTERY MATERIAL

Plastic



OLIVE-U

PRODUCT SPECIFICATIONS

Dimension W x D x H (mm) : 480 x 555 x 806
 Weight per Piece (Kg) : 4.1
 Contain per Carton : 4
 Frame Colour : Chrome
 Frame Finishing : Chrome Plating

PRODUCT DIMENSION

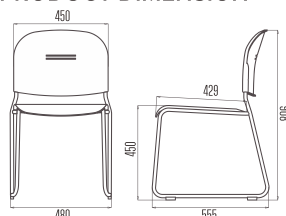

COLOUR OPTIONS & UPHOLSTERY MATERIAL

Plastic



SANKEI C-395

PRODUCT SPECIFICATIONS

Dimension W x D x H (mm) : 478 x 510 x 775
 Weight per Piece (Kg) : 3.4
 Contain per Carton : 4
 Frame Finishing : Chrome Plating
 Frame Colour : Chrome

PRODUCT DIMENSION

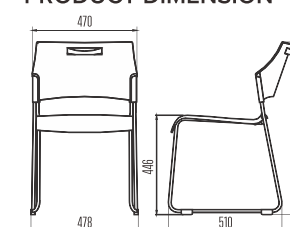

COLOUR OPTIONS & UPHOLSTERY MATERIAL

Plastic



GLORY

PRODUCT SPECIFICATIONS

Dimension W x D x H (mm) : 437 x 436 x 807
 Weight per Piece (Kg) : 3
 Contain per Carton : 4
 Frame Finishing : Powder Coating
 Frame Colour : White, Silver

PRODUCT DIMENSION

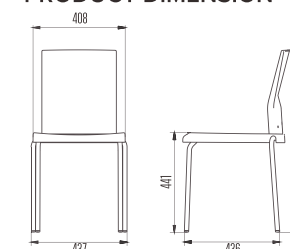

COLOUR OPTIONS & UPHOLSTERY MATERIAL

Plastic



SAMM

PRODUCT SPECIFICATIONS

Dimension W x D x H (mm) : 453 x 456 x 770
Weight per Piece (Kg) : 4.7
Contain per Carton : 4
Frame Colour : Grey, Silver, White, Orange
Frame Finishing : Powder Coating

PRODUCT DIMENSION

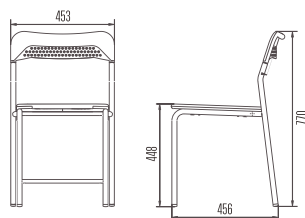

COLOUR OPTIONS & UPHOLSTERY MATERIAL

Plate



FLORA-H

PRODUCT SPECIFICATIONS

Dimension W x D x H (mm) : 495 x 415 x 675
Weight per Piece (Kg) : 3.8
Contain per Carton : 4
Frame Colour : Blue, Red, Green, Yellow, Pink, Cream, Light Blue, Light Green, Orange, Ivory
Frame Finishing : Powder Coating

PRODUCT DIMENSION

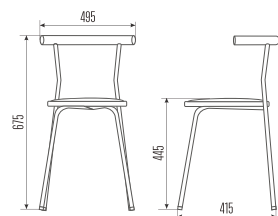

COLOUR OPTIONS & UPHOLSTERY MATERIAL

PVC



Oscar

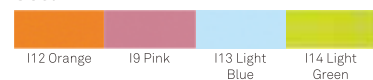

FLORA-SAN

PRODUCT SPECIFICATIONS

Dimension W x D x H (mm) : 515 x 515 x 445
Weight per Piece (Kg) : 2.5
Contain per Carton : 6
Frame Finishing : Chrome Plating
Frame Colour : Chrome

PRODUCT DIMENSION

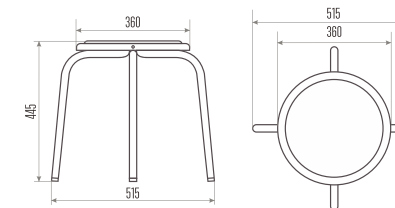

COLOUR OPTIONS & UPHOLSTERY MATERIAL

PVC



RIBBON-P

PRODUCT SPECIFICATIONS

Dimension W x D x H (mm) : 435 x 435 x 462
Weight per Piece (Kg) : 1.6
Contain per Carton : 6
Frame Finishing : Powder Coating
Frame Colour : Yellow, Black, Grey, Silver

PRODUCT DIMENSION

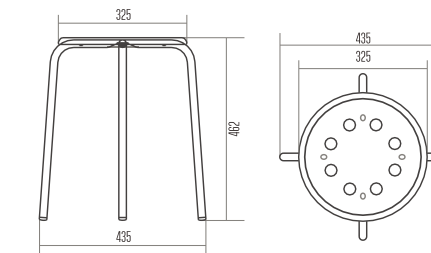

COLOUR OPTIONS & UPHOLSTERY MATERIAL

Plastic





HOBBY TABLE T-1010



TABLE T-1010



TABLE T-7575



COFFEE TABLE R-75



COFFEE TABLE T-60



COFFEE TABLE T-60 NE



COFFEE TABLE T-60 PL



COFFEE TABLE T-60
KOTATSU



TABLE T-6012 KOTATSU



FTC-6012



FTC-6012 NE



FTC-6018

HOBBY TABLE T-1010

PRODUCT SPECIFICATIONS

Dimension W x D x H (mm) : 1000 x 1000 x 750
Table Top Material : Plate
Contain per Carton : 1
Frame Colour : Ivory
Frame Finishing : Powder Coating

PRODUCT DIMENSION

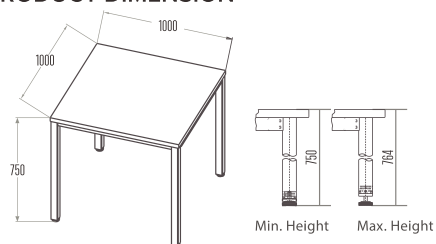

TABLE COLOUR OPTIONS



TABLE T-7575

PRODUCT SPECIFICATIONS

Dimension W x D x H (mm) : 750 x 750 x 750
Table Top Material : Particle Board Covered with PVC
Contain per Carton : 1
Frame Finishing : Powder Coating
Frame Colour : Ivory, Light Grey

PRODUCT DIMENSION

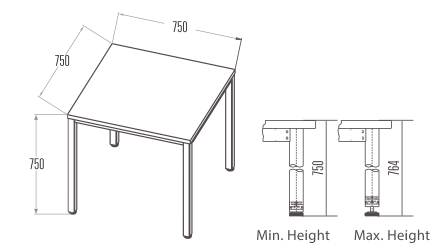

TABLE COLOUR OPTIONS



TABLE T-1010

PRODUCT SPECIFICATIONS

Dimension W x D x H (mm) : 1000 x 1000 x 750
Table Top Material : Particle Board Solid covered with PVC
Contain per Carton : 1
Frame Colour : Light Grey, Ivory
Frame Finishing : Powder Coating

PRODUCT DIMENSION

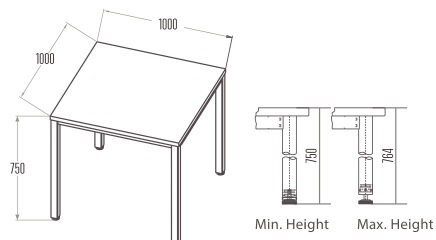
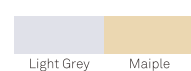

TABLE COLOUR OPTIONS



COFFEE TABLE R-75

PRODUCT SPECIFICATIONS

Dimension W x D x H (mm) : 750 x 750 x 750
Table Top Material : Particle Board Solid covered with PVC + MDF
Contain per Carton : 1
Frame Finishing : Powder Coating
Frame Colour : Black, Grey

PRODUCT DIMENSION



TABLE COLOUR OPTIONS



COFFEE TABLE T-60

PRODUCT SPECIFICATIONS

Dimension W x D x H (mm) : 600 x 600 x 750
 Weight per Piece (Kg) : 10.2
 Table Top Material : Particle Board covered with PVC + MDF
 Contain per Carton : 1
 Frame Colour : Grey, Black
 Frame Finishing : Powder Coating

PRODUCT DIMENSION

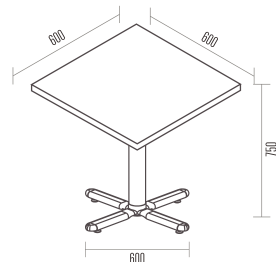

TABLE COLOUR OPTIONS



Maple

COFFEE TABLE T-60 NE

PRODUCT SPECIFICATIONS

Dimension W x D x H (mm) : 600 x 600 x 750
 Weight per Piece (Kg) : 10.2
 Table Top Material : Particle Board Solid Laminated with HPL (Top), PVC (Bottom)
 Contain per Carton : 1
 Frame Finishing : Powder Coating

PRODUCT DIMENSION

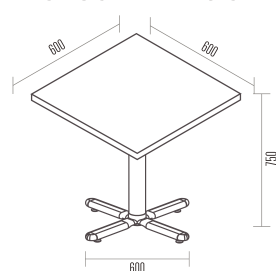

TABLE COLOUR OPTIONS



White

COFFEE TABLE T-60 PL

PRODUCT SPECIFICATIONS

Dimension W x D x H (mm) : 600 x 600 x 750
 Weight per Piece (Kg) : 11.25
 Table Top Material : Plate
 Contain per Carton : 1
 Frame Finishing : Powder Coating
 Frame Colour : Grey, Black

PRODUCT DIMENSION

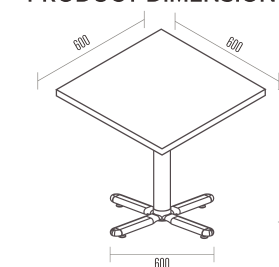

TABLE COLOUR OPTIONS



Cream
(Hammerstone)

COFFEE TABLE T-60 KOTATSU

PRODUCT SPECIFICATIONS

Dimension W x D x H (mm) : 600 x 600 x 750
 Table Top Material : MDF Honeycomb Paper + Particle Board
 Contain per Carton : 1
 Frame Finishing : Powder Coating
 Frame Colour : Black

PRODUCT DIMENSION

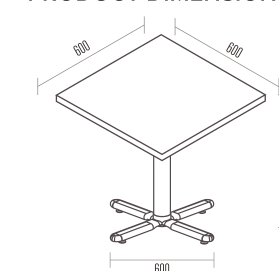

TABLE COLOUR OPTIONS



Brown

TABLE T-6012 KOTATSU

PRODUCT SPECIFICATIONS

Dimension W x D x H (mm) : 1200 x 600 x 750
 Table Top Material : MDF Honeycomb Paper
 + Particle Board
 Contain per Carton : 1
 Frame Finishing : Powder Coating
 Frame Colour : Black

PRODUCT DIMENSION

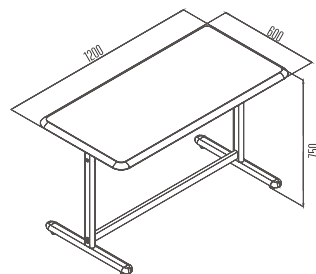

TABLE COLOUR OPTIONS



FTC-6012

PRODUCT SPECIFICATIONS

Dimension W x D x H (mm) : 1200 x 600 x 750
 Table Top Material : Particle Board Solid
 Contain per Carton : 1
 Frame Colour : Grey Hammertone
 Frame Finishing : Powder Coating

PRODUCT DIMENSION

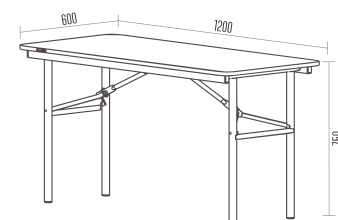

TABLE COLOUR OPTIONS



FTC-6012 NE

PRODUCT SPECIFICATIONS

Dimension W x D x H (mm) : 1200 x 600 x 750
 Table Top Material : Particle Board Solid
 Laminated with HPL (Top),
 PVC (Bottom)
 Contain per Carton : 1
 Frame Finishing : Powder Coating
 Frame Colour : Grey Hammertone

PRODUCT DIMENSION

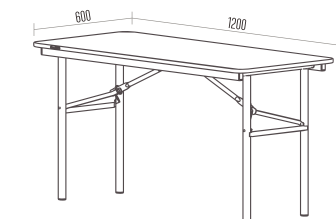

TABLE COLOUR OPTIONS



FTC-6018

PRODUCT SPECIFICATIONS

Dimension W x D x H (mm) : 1800 x 600 x 750
 Table Top Material : Particle Board Solid
 Laminated with HPL
 Contain per Carton : 1
 Frame Finishing : Powder Coating
 Frame Colour : Grey Hammertone

PRODUCT DIMENSION

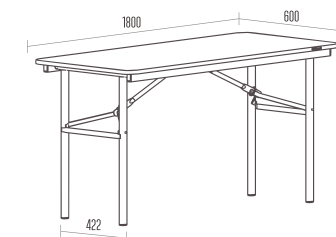

TABLE COLOUR OPTIONS



Working Meeting

Mobility design to support activities, give the best performance of company image is the best investment to reach the big success of business.



DELIGHTFULL FEELING





DUO-01



DUO-02



FITTO-SW



FITTO-FL



FITTO FL-R

DUO-01

PRODUCT SPECIFICATIONS

Dimension W x D x H (mm) : 465 x 550 x 870~985
 Weight per Piece (Kg) : 8.8
 Contain per Carton : 1
 Tilting Backrest : No
 Base : Plastic
 Frame Colour : Black

PRODUCT DIMENSION

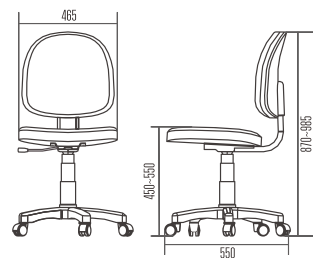

COLOUR OPTIONS & UPHOLSTERY MATERIAL

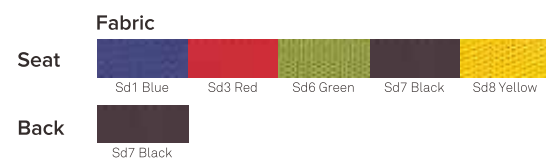

DUO-02

PRODUCT SPECIFICATIONS

Dimension W x D x H (mm) : 424 x 550 x 850~950
 Weight per Piece (Kg) : 7.3
 Contain per Carton : 1
 Tilting Backrest : No
 Base : Plastic
 Frame Colour : Black

PRODUCT DIMENSION

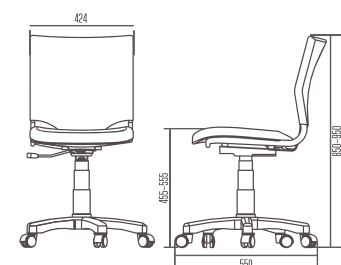

COLOUR OPTIONS & UPHOLSTERY MATERIAL

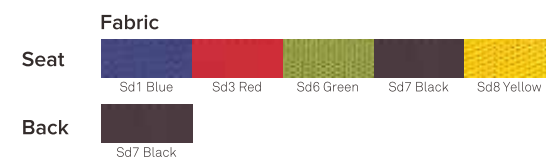

FITTO-SW

PRODUCT SPECIFICATIONS

Dimension W x D x H (mm) : 588 x 550 x 802~902
 Weight per Piece (Kg) : 6.8
 Contain per Carton : 1
 Frame Colour : Silver
 Frame Finishing : Powder Coating
 Back Material : Plastic PP (Grey)

PRODUCT DIMENSION

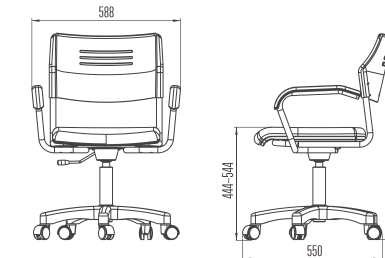

COLOUR OPTIONS & UPHOLSTERY MATERIAL

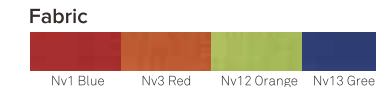

FITTO-FL

PRODUCT SPECIFICATIONS

Dimension W x D x H (mm) : 557 x 571 x 850
 Weight per Piece (Kg) : 5.9
 Contain per Carton : 4
 Frame Finishing : Silver
 Frame Colour : Powder Coating
 Back Material : Plastic PP (Grey)

PRODUCT DIMENSION

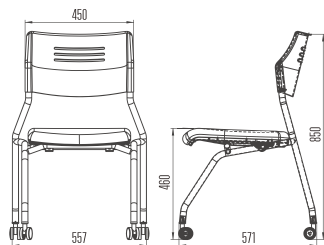

COLOUR OPTIONS & UPHOLSTERY MATERIAL



FITTO FL-R

PRODUCT SPECIFICATIONS

Dimension W x D x H (mm) : 557 x 571 x 850
 Weight per Piece (Kg) : 5.9
 Contain per Carton : 4
 Frame Colour : Silver
 Frame Finishing : Powder Coating
 Back Material : Plastic PP (Grey)

PRODUCT DIMENSION

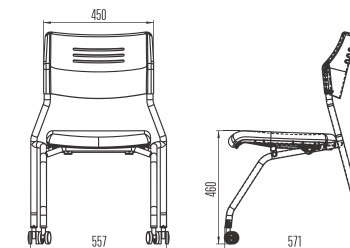

COLOUR OPTIONS & UPHOLSTERY MATERIAL

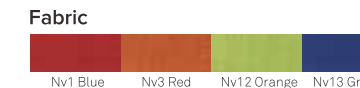



COSTA



OLIVE-SC



OLIVE-DX



FRONTY



DUO-03



DUO-04



NEO



JASMINE C-111



JASMINE C-211



COZY



LOTUS



FITTO-ST



KASAI



VISTA-N/P



COSTA

PRODUCT SPECIFICATIONS

Dimension W x D x H (mm) : 632 x 677 x 931
Weight per Piece (Kg) : 10.7
Contain per Carton : 2
Frame Colour : Chrome Plating
Frame Finishing : Chrome

PRODUCT DIMENSION

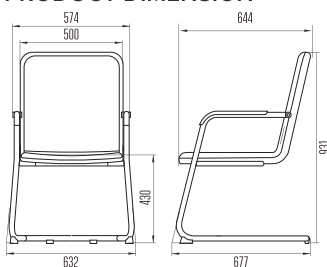

COLOUR OPTIONS & UPHOLSTERY MATERIAL

Oscar

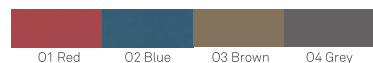

OLIVE-SC

PRODUCT SPECIFICATIONS

Dimension W x D x H (mm) : 495 x 559 x 805
Weight per Piece (Kg) : 4.3
Contain per Carton : 4
Frame Finishing : Powder Coating
 Chrome Plating
Frame Colour : Chrome, White, Ivory
Back Material : Plastic

PRODUCT DIMENSION

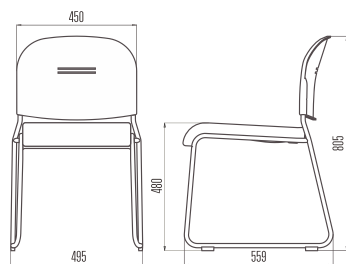

COLOUR OPTIONS & UPHOLSTERY MATERIAL

Oscar



Plastic



OLIVE-DX

PRODUCT SPECIFICATIONS

Dimension W x D x H (mm) : 495 x 559 x 868
Weight per Piece (Kg) : 5.6
Contain per Carton : 4
Frame Finishing : Chrome Plating
Frame Colour : Chrome

PRODUCT DIMENSION

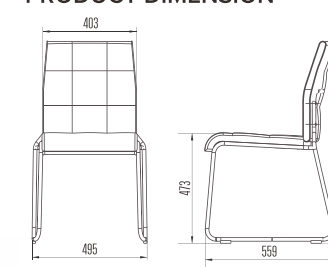

COLOUR OPTIONS & UPHOLSTERY MATERIAL

Oscar



FRONTY

PRODUCT SPECIFICATIONS

Dimension W x D x H (mm) : 538 x 620 x 855
Weight per Piece (Kg) : 8.6
Contain per Carton : 2
Frame Finishing : Powder Coating
Frame Colour : Black

PRODUCT DIMENSION

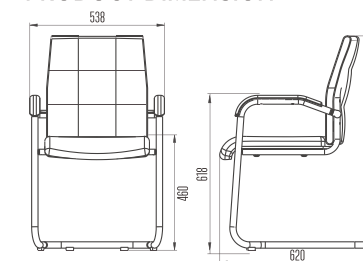

COLOUR OPTIONS & UPHOLSTERY MATERIAL

Oscar



DUO-03

PRODUCT SPECIFICATIONS

Dimension W x D x H (mm) : 437 x 577 x 867
 Weight per Piece (Kg) : 6.5
 Contain per Carton : 2
 Frame Colour : Black
 Frame Finishing : Powder Coating

PRODUCT DIMENSION

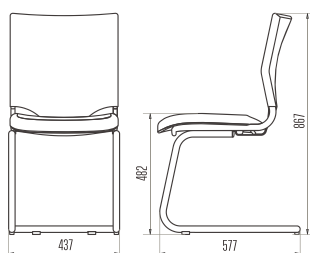

COLOUR OPTIONS & UPHOLSTERY MATERIAL

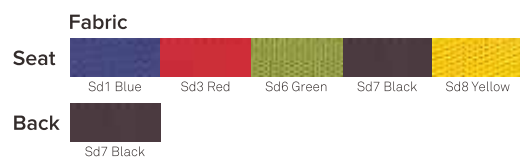

DUO-04

PRODUCT SPECIFICATIONS

Dimension W x D x H (mm) : 490 x 468 x 850
 Weight per Piece (Kg) : 6.0
 Contain per Carton : 4
 Frame Colour : Black
 Frame Finishing : Powder Coating

PRODUCT DIMENSION

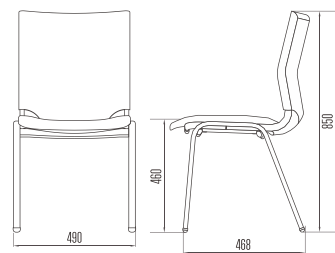

COLOUR OPTIONS & UPHOLSTERY MATERIAL

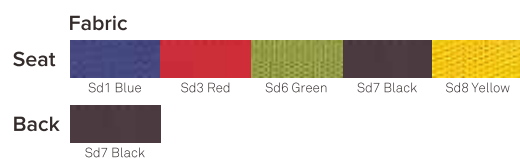

NEO

PRODUCT SPECIFICATIONS

Dimension W x D x H (mm) : 498 x 565 x 800
 Weight per Piece (Kg) : 6.1
 Contain per Carton : 4
 Frame Colour : Black
 Frame Finishing : Powder Coating

PRODUCT DIMENSION

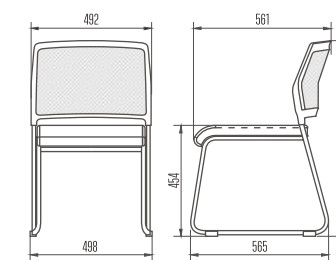

COLOUR OPTIONS & UPHOLSTERY MATERIAL



JASMINE C-111

PRODUCT SPECIFICATIONS

Dimension W x D x H (mm) : 465 x 478 x 747
 Weight per Piece (Kg) : 3.7
 Contain per Carton : 4
 Frame Colour : Chrome
 Frame Finishing : Chrome Plating
 Back Material : Plastic (White, Grey)

PRODUCT DIMENSION

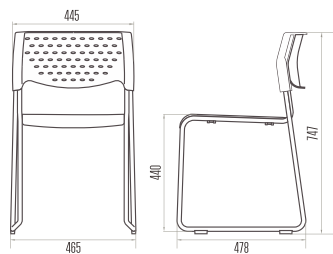

COLOUR OPTIONS & UPHOLSTERY MATERIAL

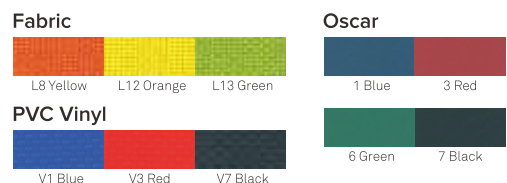

JASMINE C-211

PRODUCT SPECIFICATIONS

Dimension W x D x H (mm) : 445 x 465 x 722
 Weight per Piece (Kg) : 3.8
 Contain per Carton : 4
 Frame Colour : Chrome
 Frame Finishing : Chrome Plating
 Back Material : Plastic

PRODUCT DIMENSION

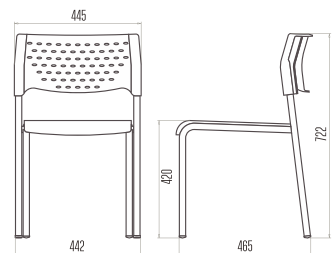

COLOUR OPTIONS & UPHOLSTERY MATERIAL

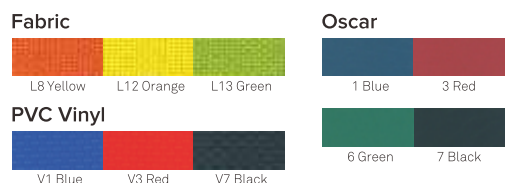

COZY

PRODUCT SPECIFICATIONS

Dimension W x D x H (mm) : 470 x 535 x 778
 Weight per Piece (Kg) : 4.3
 Contain per Carton : 4
 Frame Colour : Chrome Plating
 Frame Finishing : Chrome

PRODUCT DIMENSION

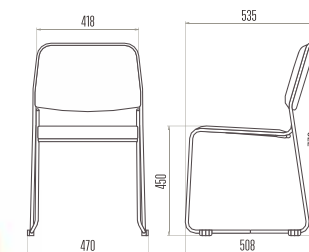

COLOUR OPTIONS & UPHOLSTERY MATERIAL

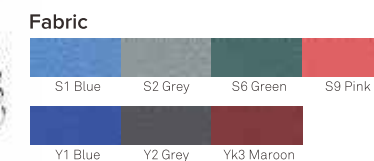

LOTUS

PRODUCT SPECIFICATIONS

Dimension W x D x H (mm) : 500 x 540 x 700
 Weight per Piece (Kg) : 3.5
 Contain per Carton : 4
 Frame Colour : Chrome Plating
 Frame Colour : Chrome
 Back Material : Plastic (Cream, Grey)

PRODUCT DIMENSION

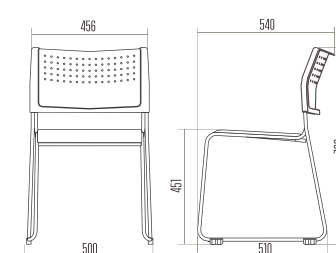

COLOUR OPTIONS & UPHOLSTERY MATERIAL

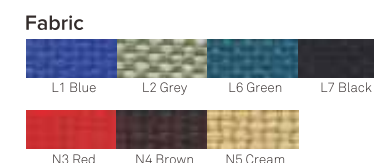

FITTO-ST

PRODUCT SPECIFICATIONS

Dimension W x D x H (mm) : 575 x 520 x 835
 Weight per Piece (Kg) : 6.5
 Contain per Carton : 4
 Frame Colour : Silver
 Frame Finishing : Powder Coating
 Back Material : Plastic PP (Grey)

PRODUCT DIMENSION

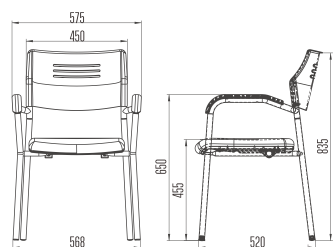

COLOUR OPTIONS & UPHOLSTERY MATERIAL

Fabric

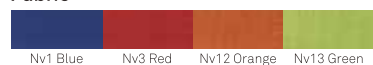

KASAI

PRODUCT SPECIFICATIONS

Dimension W x D x H (mm) : 470 x 480 x 755
 Weight per Piece (Kg) : 3.9
 Contain per Carton : 4
 Frame Colour : Silver
 Frame Finishing : Powder Coating

PRODUCT DIMENSION

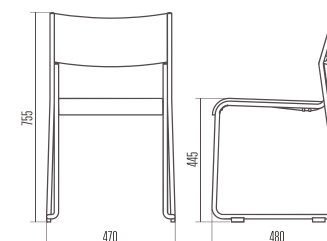

COLOUR OPTIONS & UPHOLSTERY MATERIAL

Fabric

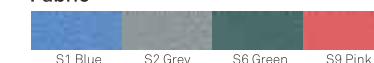

Oscar



VISTA-N/P

PRODUCT SPECIFICATIONS

Dimension W x D x H (mm) : 435 x 560 x 785
 Weight per Piece (Kg) : 6.7
 Contain per Carton : 2
 Frame Colour : Black, Chrome
 Frame Finishing : Powder Coating (P)
 Chrome Plating (N)

PRODUCT DIMENSION

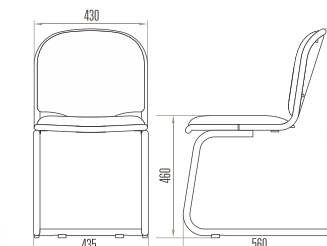

COLOUR OPTIONS & UPHOLSTERY MATERIAL

Fabric

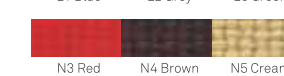
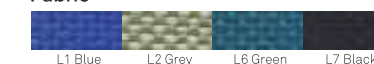



TU-7014



TU-6012



TU-6012 LOW



TU-7575 P



T-5512



T-7014 L/R



T-7014



T-7012



HTU-6014



CHIBA DESK-7014



KUMI-MT



KUMI-WS



KUMI-ED



KUMI-MD



KUMI-SD



KUMI-FD



KUMI AST



KUMI WAGON-2D/3D

T-5512

PRODUCT SPECIFICATIONS

Dimension W x D x H (mm) : 1200 x 550 x 450~460
 Weight per Piece (Kg) : 24
 Contain per Carton : 1
 Table Top Material : Particle Board + MDF
 Covered with PVC
 Frame Colour : Ivory
 Frame Finishing : Powder Coating



PRODUCT DIMENSION

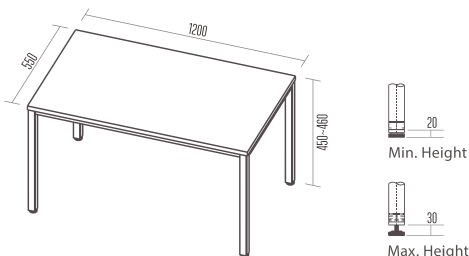

TABLE COLOUR OPTIONS

Particle Board + MDF covered with PVC



T-7014 L/R

PRODUCT SPECIFICATIONS

Dimension W x D x H (mm) : 1400 x 800 x 750~760
 Weight per Piece (Kg) : 27
 Contain per Carton : 1
 Table Top Material : Particle Board
 Covered with PVC
 Frame Colour : Silver
 Frame Finishing : Powder Coating



PRODUCT DIMENSION

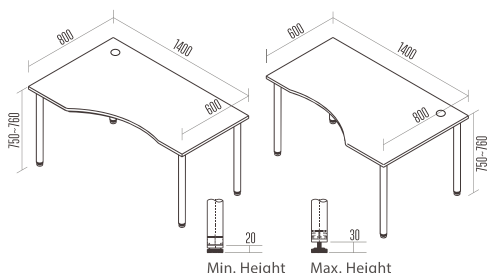

TABLE COLOUR OPTIONS

Particle Board covered with PVC



T-7014

PRODUCT SPECIFICATIONS

Dimension W x D x H (mm) : 1400 x 700 x 750~760
 Weight per Piece (Kg) : 24
 Contain per Carton : 1
 Table Top Material : Particle Board
 Covered with PVC
 Frame Finishing : Powder Coating
 Frame Colour : Silver

PRODUCT DIMENSION

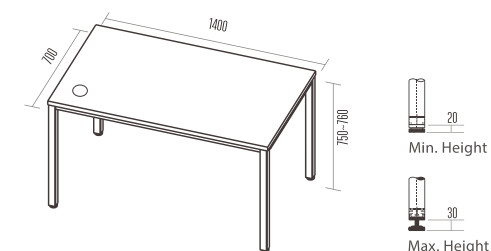

TABLE COLOUR OPTIONS

Particle Board covered with PVC



T-7012

PRODUCT SPECIFICATIONS

Dimension W x D x H (mm) : 1200 x 700 x 750~760
 Weight per Piece (Kg) : 18.5
 Contain per Carton : 1
 Table Top Material : Particle Board
 Covered with PVC
 Frame Finishing : Powder Coating
 Frame Colour : Silver



PRODUCT DIMENSION

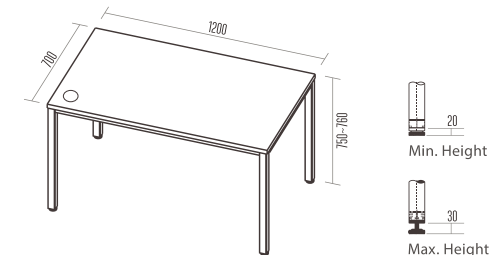

TABLE COLOUR OPTIONS

Particle Board covered with PVC



KUMI WS-1244 / 1424 / 1436



Partisi MDF with fabric cover



Desk Grommate

PRODUCT SPECIFICATIONS

Dimension W x D x H (mm) : 1200 x 2400 x 750 (WS-1224)
 1400 x 2400 x 750 (WS-1424)
 1400 x 3600 x 750 (WS-1436)
 1200 x 30 x 400 (partisi front)
 690 x 30 x 400 (partisi side)

Contain per Carton : 1
 Table Top Material : Particle Board Solid
 Laminated with HPL

Partisi Material : MDF with fabric cover
 Frame Finishing : Powder Coating Doff
 Frame Colour : White Doff, Black Doff

PRODUCT DIMENSION

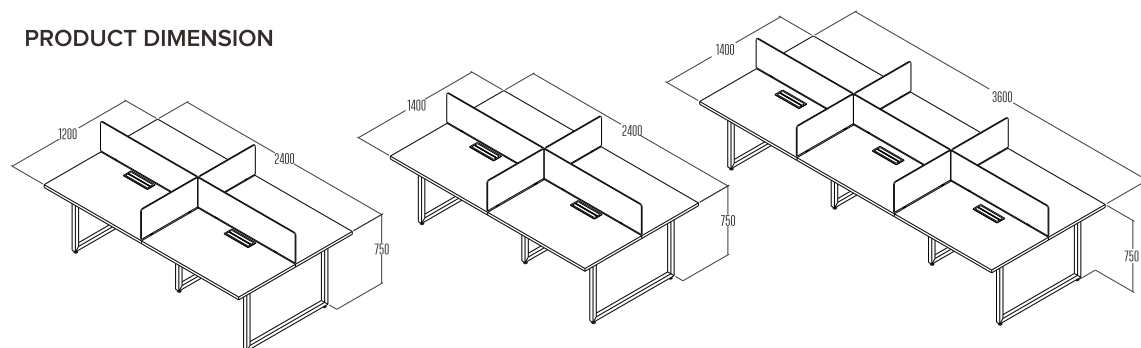

TABLE COLOUR OPTIONS

Particle Board + Laminated HPL



Dark Brown Oak Pastel Oak



KUMI-ED

PRODUCT SPECIFICATIONS

Dimension W x D x H (mm) : 1800 x 700 x 750
 1000 x 600 x 750

Weight per Piece (Kg) : 61.36
 Contain per Carton : 2

Table Top Material : Particle Board Solid
 Laminated with HPL

Frame Finishing : Powder Coating Doff
 Frame Colour : White Doff, Black Doff

PRODUCT DIMENSION

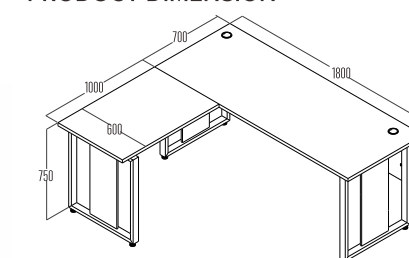

TABLE COLOUR OPTIONS

Particle Board + Laminated HPL



Dark Brown Oak Pastel Oak



KUMI-MD

PRODUCT SPECIFICATIONS

Dimension W x D x H (mm) : 1400 x 700 x 750
 Weight per Piece (Kg) : 45.06

Contain per Carton : 1
 Table Top Material : Particle Board Solid
 Laminated with HPL

Frame Colour : White Doff, Black Doff
 Frame Finishing : Powder Coating Doff

PRODUCT DIMENSION

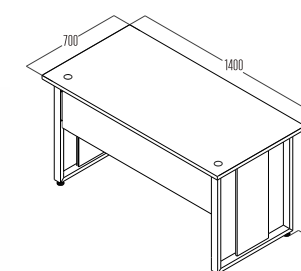

TABLE COLOUR OPTIONS

Particle Board + Laminated with HPL



Dark Brown Oak Pastel Oak

KUMI-SD

PRODUCT SPECIFICATIONS

Dimension W x D x H (mm) : 1200 x 700 x 750
 Weight per Piece (Kg) : 42.33
 Contain per Carton : 1
 Table Top Material : Particle Board Solid
 Laminated with HPL
 Frame Colour : White Doff, Black Doff
 Frame Finishing : Powder Coating Doff

PRODUCT DIMENSION

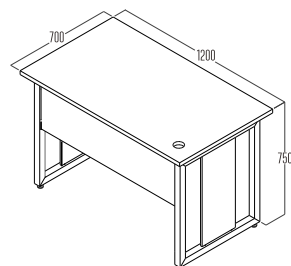

TABLE COLOUR OPTIONS

Particle Board + Laminated with HPL



KUMI-FD

PRODUCT SPECIFICATIONS

Dimension W x D x H (mm) : 1200 x 600 x 750
 Weight per Piece (Kg) : 45.06
 Contain per Carton : 2
 Table Top Material : Particle Board Solid
 Laminated with HPL
 Frame Finishing : Powder Coating
 Frame Colour : White Doff, Black Doff

PRODUCT DIMENSION

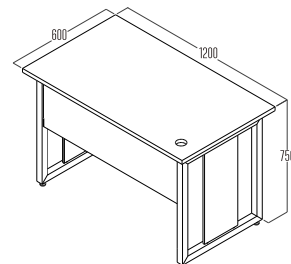
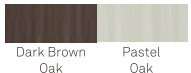

TABLE COLOUR OPTIONS

Particle Board + Laminated HPL



KUMI AST-1200 / 1400

PRODUCT SPECIFICATIONS

Dimension W x D x H (mm) : 1200 x 600 x 750 (AST-1200)
 1400 x 700 x 750 (AST-1400)
 Contain per Carton : -
 Table Top Material : Particle Board Solid
 Laminated with HPL
 Frame Colour : Powder Coating
 Frame Finishing : White Doff, Black Doff

PRODUCT DIMENSION

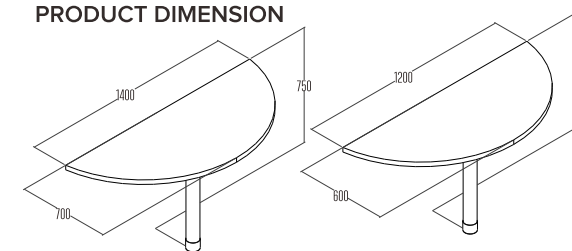

TABLE COLOUR OPTIONS

Particle Board + Laminated HPL



KUMI WAGON-2D / 3 D

PRODUCT SPECIFICATIONS

Dimension W x D x H (mm) : 420 x 500 x 600
 Contain per Carton : 1
 Material : Particle Board
 Covered with PVC

PRODUCT DIMENSION

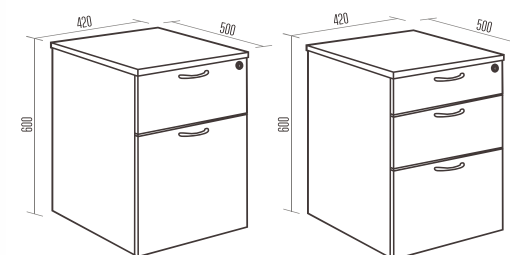

TABLE COLOUR OPTIONS

Particle Board Covered with PVC



KUMI WAGON 2D

KUMI WAGON 3D



CHIBA SC-201



CHIBA SC-202



CHIBA SD-203



CHIBA SD-204



CHIBA SD/G-206



CHIBA SD/G-207



FC-113



FC-114



CHIBA MF/6-18



CHIBA MF/8-18



CHIBA MF/AUM/203



CHIBA MF/AUM/204



LOCKER



CK-810 & CK-1800



MAPPLE RACK-L/M/S

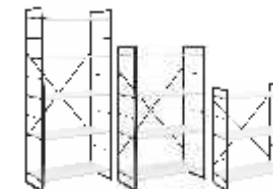

GREY RACK-L/M/S



EXECUTIVE RACK-L/M/S

CHIBA SC-201

PRODUCT SPECIFICATIONS

Dimension W x D x H (mm) : 915 x 460 x 1830
 Panel Material : Steel with PC
 Frame Colour : Light Grey
 Frame Finishing : Powder Coating

PRODUCT DIMENSION

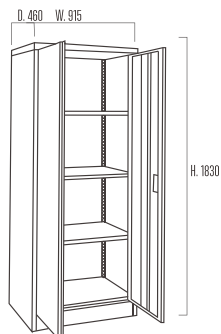

COLOUR OPTIONS

Steel with PC



Light Grey

CHIBA SC-202

PRODUCT SPECIFICATIONS

Dimension W x D x H (mm) : 915 x 460 x 915
 Panel Material : Steel with PC
 Frame Colour : Light Grey
 Frame Finishing : Powder Coating

PRODUCT DIMENSION

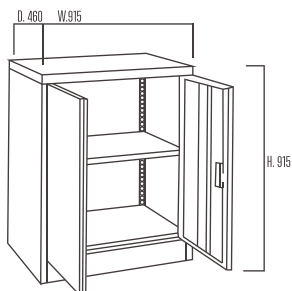

COLOUR OPTIONS

Steel with PC



Light Grey



CHIBA SD-203

PRODUCT SPECIFICATIONS

Dimension W x D x H (mm) : 915 x 460 x 1830
 Panel Material : Steel with PC
 Frame Colour : Light Grey
 Frame Finishing : Powder Coating

PRODUCT DIMENSION



COLOUR OPTIONS

Steel with PC



Light Grey

CHIBA SD-204

PRODUCT SPECIFICATIONS

Dimension W x D x H (mm) : 915 x 460 x 915
 Panel Material : Steel with PC
 Frame Colour : Light Grey
 Frame Finishing : Powder Coating

PRODUCT DIMENSION

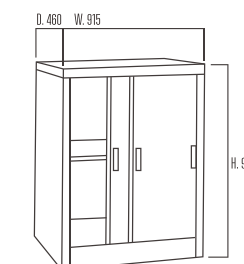

COLOUR OPTIONS

Steel with PC



Light Grey

CHIBA SD/G-206

PRODUCT SPECIFICATIONS

Dimension W x D x H (mm) : 915 x 460 x 1830
 Panel Material : Steel with PC
 Frame Colour : Light Grey
 Frame Finishing : Powder Coating

PRODUCT DIMENSION

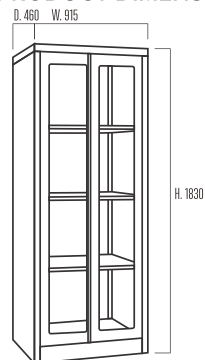

COLOUR OPTIONS

Steel with PC



Light Grey

CHIBA SD/G-207

PRODUCT SPECIFICATIONS

Dimension W x D x H (mm) : 915 x 460 x 915
 Panel Material : Steel with PC
 Frame Colour : Light Grey
 Frame Finishing : Powder Coating

PRODUCT DIMENSION

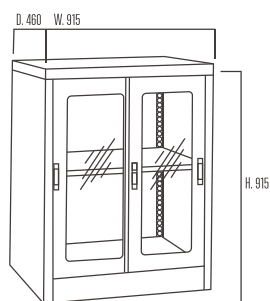

COLOUR OPTIONS

Steel with PC



Light Grey



FC-113

PRODUCT SPECIFICATIONS

Dimension W x D x H (mm) : 465 x 620 x 915
 Panel Material : Steel with PC
 Frame Colour : Light Grey
 Frame Finishing : Powder Coating

PRODUCT DIMENSION

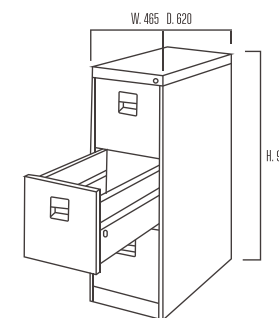

COLOUR OPTIONS

Steel with PC



Light Grey



FC-114

PRODUCT SPECIFICATIONS

Dimension W x D x H (mm) : 465 x 620 x 1300
 Panel Material : Steel with PC
 Frame Colour : Light Grey
 Frame Finishing : Powder Coating

PRODUCT DIMENSION

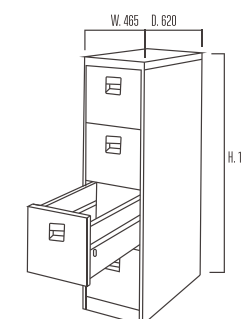

COLOUR OPTIONS

Steel with PC



Light Grey

CHIBA MF/6-18

PRODUCT SPECIFICATIONS

Dimension W x D x H (mm) : 1000 x 3300 x 1830
 Panel Material : Steel with PC
 Frame Colour : Light Grey
 Frame Finishing : Powder Coating

PRODUCT DIMENSION

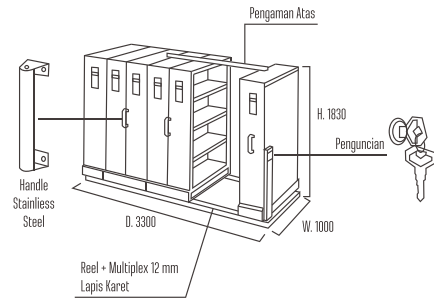

COLOUR OPTIONS

Steel with PC



CHIBA MF/AUM/203

PRODUCT SPECIFICATIONS

Dimension W x D x H (mm) : 2000 x 4400 x 2200
 Panel Material : Steel with PC
 Frame Colour : Light Grey
 Frame Finishing : Powder Coating

PRODUCT DIMENSION

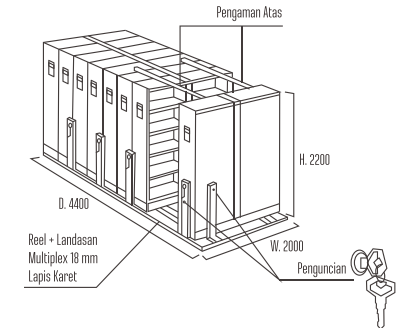

COLOUR OPTIONS

Steel with PC



CHIBA MF/8-18

PRODUCT SPECIFICATIONS

Dimension W x D x H (mm) : 1000 x 4100 x 1830
 Panel Material : Steel with PC
 Frame Colour : Light Grey
 Frame Finishing : Powder Coating

PRODUCT DIMENSION

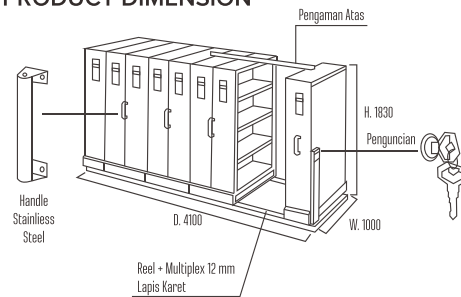

COLOUR OPTIONS

Steel with PC



CHIBA MF/AUM/204

PRODUCT SPECIFICATIONS

Dimension W x D x H (mm) : 2000 x 5200 x 2200
 Panel Material : Steel with PC
 Frame Colour : Light Grey
 Frame Finishing : Powder Coating

PRODUCT DIMENSION

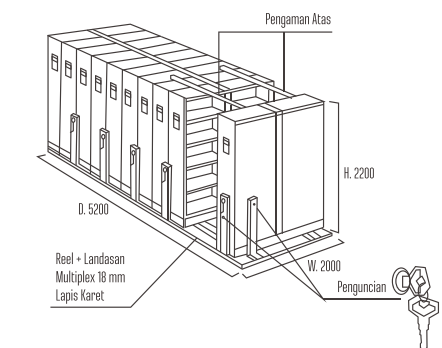

COLOUR OPTIONS

Steel with PC



LOCKER

PRODUCT SPECIFICATIONS

Dimension W x D x H (mm) : 300 x 450 x 1800 (LC-3)
300 x 450 x 1800 (LC-4)
900 x 450 x 1800 (LC-9)
900 x 450 x 1800 (LC-12)

Contain per Carton : 1
Frame Colour : Silver
Frame Finishing : Powder Coating

PRODUCT DIMENSION

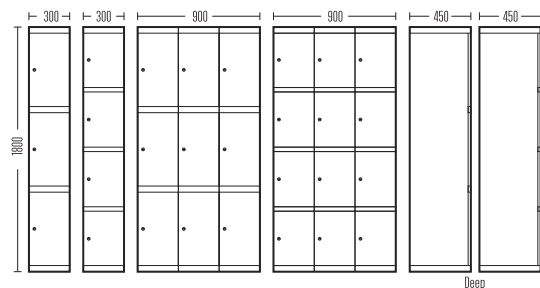

COLOUR OPTIONS

Steel with PC



Light Grey



LC-3

LC-9

CK-810 & CK-1800

PRODUCT SPECIFICATIONS

Dimension W x D x H (mm) : 800 x 400 x 950 (CK-810)
800 x 400 x 1800 (CK-1800)

Contain per Carton : 1
Panel Material : Particle Board
Covered with PVC

PRODUCT DIMENSION

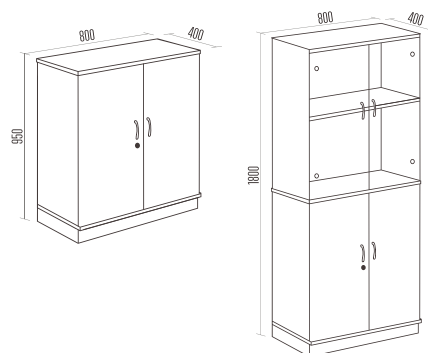

PANEL COLOUR OPTIONS

Particle Board covered with PVC

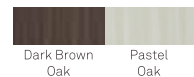

Dark Brown
Oak

Pastel
Oak



CK-810

CK-1800

MAPPLE RACK-L/M/S



PRODUCT SPECIFICATIONS

Dimension W x D x H (mm) : 600 x 400 x 1800 (L)
600 x 400 x 1600 (M)
600 x 400 x 1100 (S)

Weight per Piece (Kg) : 30~32 / 25~27 / 21~23
Contain per Carton : 1
Frame Finishing : Powder Coating
Frame Colour : Silver

COLOUR OPTIONS

Particle Board covered with PVC



Maple

PRODUCT DIMENSION

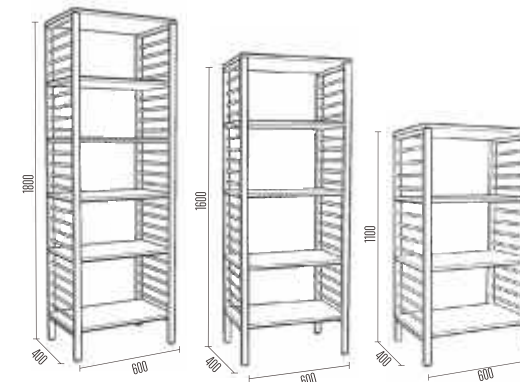

GREY RACK-L/M/S

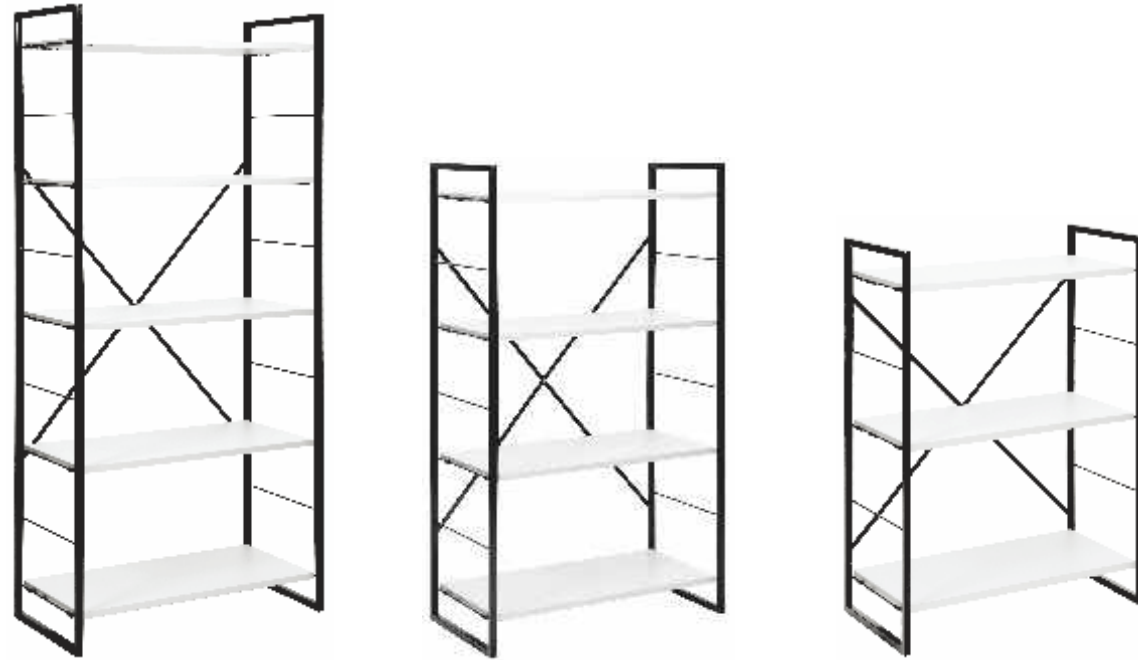

PRODUCT SPECIFICATIONS

Dimension W x D x H (mm) : 800 x 400 x 1800 (L)
800 x 400 x 1400 (M)
800 x 400 x 1000 (S)
Weight per Piece (Kg) : 21~23 / 16~18 / 12~14
Contain per Carton : 1
Frame Finishing : Powder Coating
Frame Colour : Black

COLOUR OPTIONS

Particle Board (Grey Rack)



PRODUCT DIMENSION

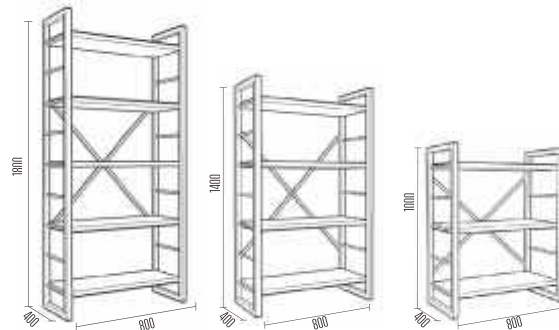

EXECUTIVE RACK-L/M/S



PRODUCT SPECIFICATIONS

Dimension W x D x H (mm) : 800 x 400 x 1800 (L)
800 x 400 x 1400 (M)
800 x 400 x 1000 (S)
Weight per Piece (Kg) : 30~32 / 26~28 / 17~19
Contain per Carton : 1
Frame Finishing : Powder Coating
Frame Colour : Black

COLOUR OPTIONS

Particle Board + MDF covered with PVC (Exe. Rack)



PRODUCT DIMENSION

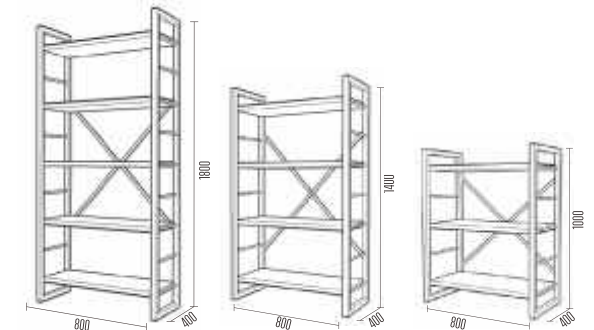



FUJI-SS



FUJI-DS



ASO-SS



ASO-DS



KT-01 CAVIS



KT-02 CAVIS



KT-02 OLIVE



ATC-01



KOGU KT-03



KOGU-PC



KOGU-TS

FUJI-SS

PRODUCT SPECIFICATIONS

Dimension W x D x H (mm) : 675 x 910 x 1000
 Weight per Piece (Kg) : 16.6
 Contain per Carton : 1
 Frame Material : Steel Pipe
 Frame Finishing : Powder Coating

PRODUCT DIMENSION

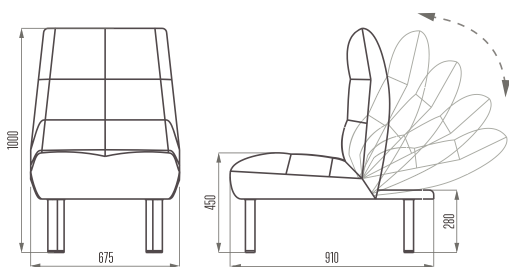

COLOUR OPTIONS & UPHOLATERY MATERIAL

Oscar



FUJI-DS

PRODUCT SPECIFICATIONS

Dimension W x D x H (mm) : 1300 x 910 x 1000
 Weight per Piece (Kg) : 24.6
 Contain per Carton : 1
 Frame Material : Steel Pipe
 Frame Finishing : Powder Coating

PRODUCT DIMENSION

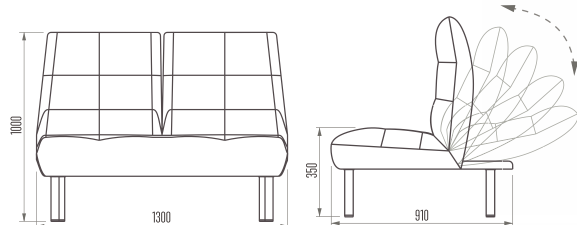

COLOUR OPTIONS & UPHOLATERY MATERIAL

Oscar



ASO-SS

PRODUCT SPECIFICATIONS

Dimension W x D x H (mm) : 780 x 913 x 1000
 Weight per Piece (Kg) : 16.6
 Contain per Carton : 1
 Frame Material : Steel Pipe
 Frame Finishing : Powder Coating

PRODUCT DIMENSION

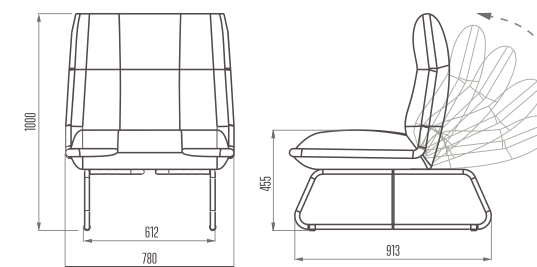

COLOUR OPTIONS & UPHOLATERY MATERIAL

Oscar



ASO-DS

PRODUCT SPECIFICATIONS

Dimension W x D x H (mm) : 1300 x 913 x 1000
 Weight per Piece (Kg) : 18.7
 Contain per Carton : 1
 Frame Material : Steel Pipe
 Frame Finishing : Powder Coating

PRODUCT DIMENSION

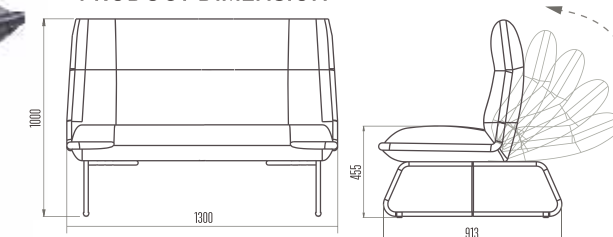

COLOUR OPTIONS & UPHOLATERY MATERIAL

Oscar



KT-01 CAVIS

PRODUCT SPECIFICATIONS

Dimension W x D x H (mm) : 1450 x 535 x 780 (3 Seats)
2060 x 535 x 780 (4 Seats)
Frame Colour : Ivory
Frame Finishing : Powder Coating

PRODUCT DIMENSION

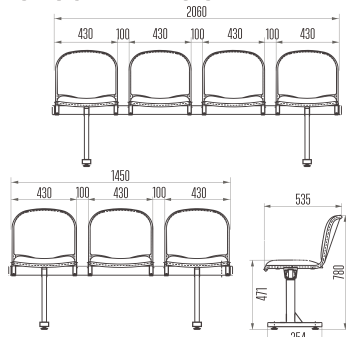

COLOUR OPTIONS & UPHOLSTERY MATERIAL



KT-02 CAVIS

PRODUCT SPECIFICATIONS

Dimension W x D x H (mm) : 1741 x 498 x 780 (3 Seats)
2298 x 498 x 780 (4 Seats)
Frame Color : Grey
Frame Finishing : Powder Coating

PRODUCT DIMENSION

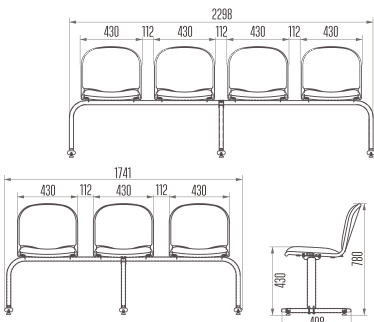

COLOUR OPTIONS & UPHOLSTERY MATERIAL



KT-02 OLIVE

PRODUCT SPECIFICATIONS

Dimension W x D x H (mm) : 1741 x 498 x 798 (3 Seats)
2298 x 498 x 798 (4 Seats)
Frame Colour : Grey
Frame Finishing : Powder Coating

PRODUCT DIMENSION

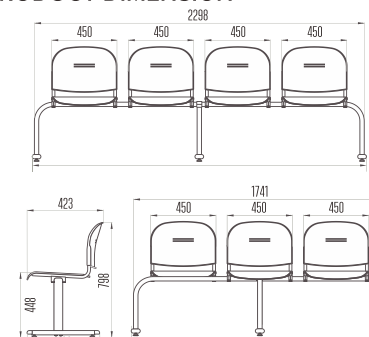

COLOUR OPTIONS & SEAT-BACK MATERIAL

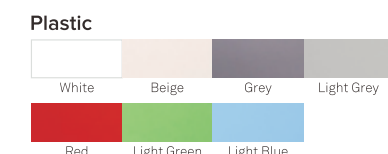

ATC-01

PRODUCT SPECIFICATIONS

Dimension W x D x H (mm) : 1160 x 679 x 865
Contain per Carton : 2
Frame Material : Square Pipe
Frame Finishing : Powder Coating

PRODUCT DIMENSION

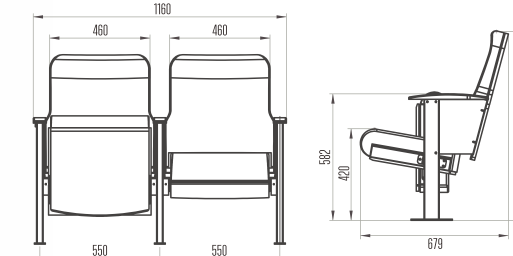

COLOUR OPTIONS & UPHOLSTERY MATERIAL

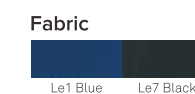

KOGU KT-03



PRODUCT SPECIFICATIONS

Dimension W x D x H (mm) : 1300 x 650 x 870 (2 Seats)
1900 x 650 x 870 (3 Seats)
2500 x 650 x 870 (4 Seats)

Frame Colour : Grey
Frame Finishing : Powder Coating
Leg & Arm : Aluminium Diecast

COLOUR OPTIONS

Steel Pipe



PRODUCT DIMENSION

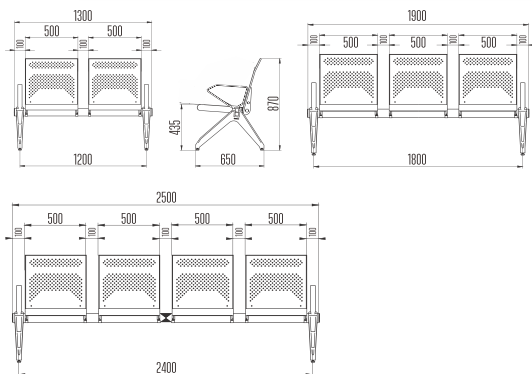

KUGU-TS

PRODUCT SPECIFICATIONS

Dimension W x D x H (mm) : 1520 x 508 x 450 (3 Seats)
2050 x 508 x 450 (4 Seats)

Contain per Carton : 1
Frame Colour : Grey
Frame Finishing : Powder Coating
Seat Material : Plate

PRODUCT DIMENSION

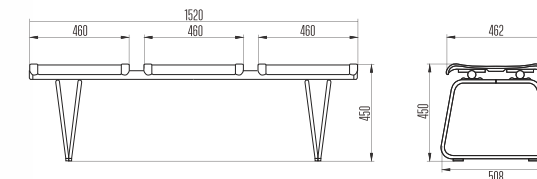

COLOUR OPTIONS

Steel Pipe

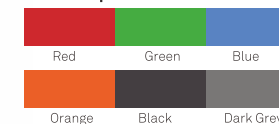

KOGU-PC

PRODUCT SPECIFICATIONS

Dimension W x D x H (mm) : 1300 x 650 x 870 (2 Seats)
1900 x 650 x 870 (3 Seats)
2500 x 650 x 870 (4 Seats)

Contain per Carton : 1
Frame Colour : Silver
Frame Finishing : Powder Coating
Seat-Back Material : Polywood + Foam + Oscar
Leg & Arm : Aluminium Diecast



PRODUCT DIMENSION

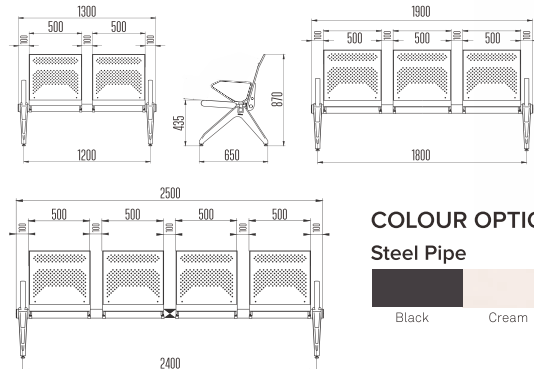

COLOUR OPTIONS

Steel Pipe





accessories



TM-01

*Suitable for Meeting Chair
Cozy, Jasmine C-111, Kasai, Sankei C-371,
Sankei C-395, Yuki



TM-02

*Suitable for Hotel & Restaurant Chair
Caesar, Jiro, Hanako, Taro, Sakata



TF-01

*Suitable for Folding Chair
CAL, Cosmo 541/542, Daishogun, Daishogun Plus,
Yamato AA, Yamato NN, Yamato HAA, Yasuka Sliding



TF-02

*Suitable for Folding Chair
CAL, Cosmo 541/542, Daishogun, Daishogun Plus,
Yamato AA, Yamato NN, Yamato HAA, Yasuka Sliding

Fabric



NEW SCOTLAND (N)
Flammability Complies with BSEN 1021-1:1994-Part 1 (Cigarette) & Californis Technical Bulletin No. 117-1980 Section E. (Note: Flammability Performance is dependent on the foam used).

SPRINGS (S)
Flammability Complies with BSEN 1021-1:2006-(Cigarette). Tested in combination with UBM foam 32 kg/m3.

DALLAS (D)
Flammability Complies with BSEN 1021-1:2006-(Cigarette). Tested in combination with UBM foam 32 kg/m3.



PVC

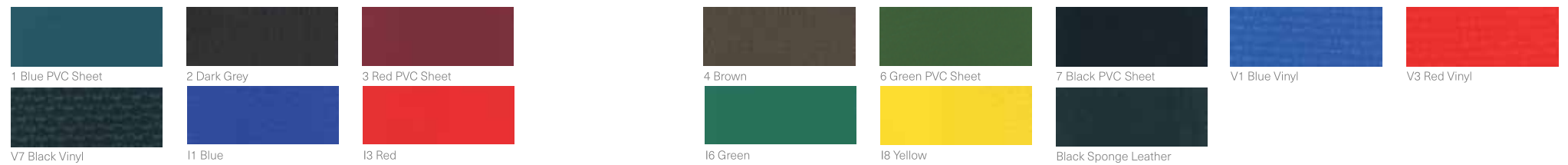

Oscar



Plastic

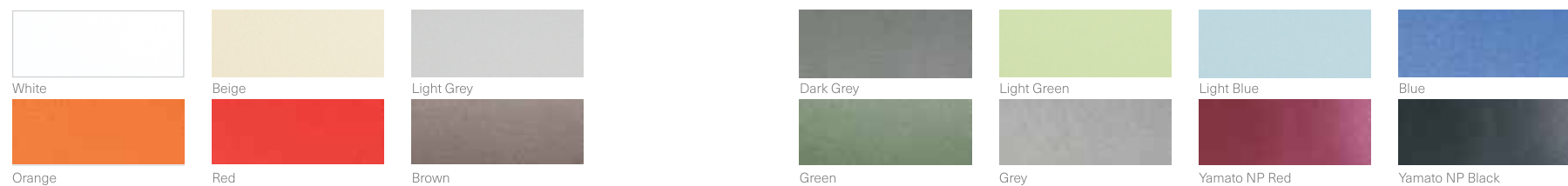

COLOUR SAMPLE

COLOUR SAMPLE

Industrial Standards of Indonesia and Japanese Industrial Standard. This achievement cannot be separated by the three factors that make Chitose stand out from the rest : stability in quality, comfort, safe and healthy for the user, as well as a being aesthetically pleasing. From time to time, the quality of Chitose products has been strictly maintained. It is made possible by the production process; which referred to the integrated system of automation. The implementation of the system result in uniform and consistent shapes and quality for all Chitose products.

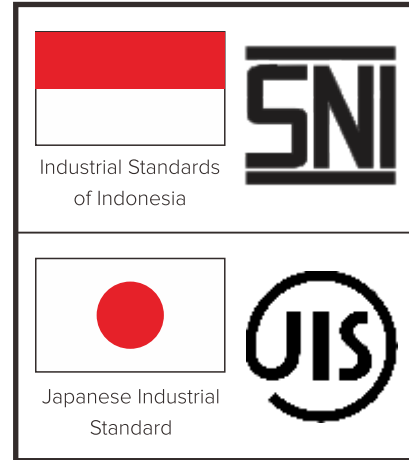

ROTARY TEST

The testing standard for chairs complies with JIS S 1032-1994 (8.3)

Pressure weight 105 kg
Rotation Count 4.255 times

ENDURANCE TEST

The testing standard for chairs complies with JIS S 1032-204 (10.2e)

1ST TEST (FOR SEAT) (JIS S 1203.75)

Hydraulic Pressure 950N : 96.9 kg
Pressure Cycles 20 times/min.
3 sec./cycle
Frequency

- Folding Chair 12.500 times
- Swivel Chair 50.000 times
- Non Swivel Chair 50.000 times
- Stool Chair 50.000 times



2ND TEST (FOR BACK) (JIS S 1203.76)

Hydraulic Pressure 330N : 33.7 kg
Pressure Cycles 20 times/min.
3 sec./cycle
Frequency

- Folding Chair 12.500 times
- Swivel Chair 50.000 times
- Non Swivel Chair 50.000 times



IMPACT TEST

The testing standard for chairs complies with JIS S 1032-2004 (10.3a)

Pressure Weight 25 kg
Frequency 10 times
Stroke Height

- Folding Chair 140 mm
- Swivel Chair 180 mm
- Non Swivel Chair 180 mm
- Stool Chair 180 mm



MOMENTUM TEST

The testing standard for chairs complies with CINT Standard

Load Weight 55 kg
Stroke Height 50 mm
(from bottom of the chair's front feet to the floor)

Impact Count 12.500 times

- Folding Chair 2000 times
- Non Swivel Chair 3000 times
- Stool Chair 3000 times

A

ASO-DS	108
ASO-SS	108
ATC-01	110
AYUMI	36
AYUMI-HD	37

C

CAL	12
CAESAR-N/P	48
CALLISTO-N/P	50
CAVIS	50
CHIBA DESK-7014	87
CHIBA SC-201	95
CHIBA SC-202	95
CHIBA SD-203	96
CHIBA SD-204	96
CHIBA SD/G-206	97
CHIBA SD/G-207	97
CHIBA MF/6-18	99
CHIBA MF/8-18	99
CHIBA MF/AUM/203	100
CHIBA MF/AUM/204	100
CK-810	101
CK-1800	101
COFFEE TABLE R-75	58
COFFEE TABLE T-60	59
COFFEE TABLE T-60 KOTATSU	60
COFFEE TABLE T-60 NE	59
COFFEE TABLE T-60 PL	60
COLOUR BOX-35	42
COLOUR BOX-35 D	42
COLOUR BOX-35 S	42
COLOUR BOX-89	42
COSMO-541	10
COSMO-542	10
COSMO-941	10
COSMO-942	10
COSMO-MNR	18
COSMO-MNR PLUS	19
COSMO-MPR	18
COSMO-MPR PLUS	19
COSMO-LMPR	20
COSTA	73
COZY	78

D

DAISHOGUN	11
DAISHOGUN LMUP	19
DUO-01	67
DUO-02	67
DUO-03	75
DUO-04	75

E

ECHOOL	26
ECHOOL-HD	28
ECHOOL-JP	25
ECHOOL-PLUS	27
EXECUTIVE RACK-L	104
EXECUTIVE RACK-M	104
EXECUTIVE RACK-S	104

F

FC-113	98
FC-114	98
FITTO-FL	69
FITTO-FL-R	70
FITTO-ST	79
FITTO-SW	68
FLORA-H	53
FLORA-SAN	54
FRONTY	74
FTC-6012	61
FTC-6018	62
FTC-6012 NE	62
FUJI-DS	107
FUJI-SS	107

G

GLORY	52
GREY RACK-L	103
GREY RACK-M	103
GREY RACK-S	103

H

HANA-KO-S	47
HOBBY TABLE T-1010	57
HTU-6014	87

J

JASMINE C-111	77
JASMINE C-211	77
JIRO-S	48

K

KASAI	80
KEIKO	35
KEIKO-FB	33
KEIKO-FB HD	34
KEIKO-JP	32
KEIKO-PLUS	35
KOGU KT-03	111
KOGU-PC	111
KOGU-TS	112
KT-01 CAVIS	109
KT-02 CAVIS	109

KT-02 OLIVE	110
KUMI-AST	94
KUMI-ED	90
KUMI-FD	91
KUMI-MD	90
KUMI-MT	88
KUMI-SD	91
KUMI WAGON-2D	92
KUMI WAGON-3D	92
KUMI-WS	89

L

LOCKER	101
LOTUS	78

M

MANABU-AH 01	38
MANABU-AH 01 HD	39
MANABU-AH 02	40
MANABU-P	29
MANABU-P HD	31
MANABU-P JP	29
MANABU-P PLUS	30
MAPPLE RACK-L	102
MAPPLE RACK-M	102
MAPPLE RACK-S	102

N

NEO	76
-----	----

O

OLIVE-A	51
OLIVE A-LM	20
OLIVE-DX	74
OLIVE-SC	73
OLIVE-U	51

P

PRINCE-N/P	49
------------	----

R

RIBBON-P	54
----------	----

S

SAKATA-N/P	49
SAMM	53
SANKEI C -395	52
SHIRO W-1218	42
SHIRO W-1224	42
SHIRO WS-1218	42
SHIRO WS-1224	42

T

T-5512	85
T-7012	86
T-7014	86
T-7014 L/R	85
TABLE T-1010	57
TABLE T-6012 KOTATSU	61
TABLE T-7575	58
TARO-S	47
TF-01	114
TF-02	114
TM-01	114
TM-02	114
TU-6012	83
TU-6012 LOW	84
TU-7014	83
TU-7575 P	84

U

UNI DESK & CHAIR	41
------------------	----

V

VISTA-N/P	80
-----------	----

Y

YAMATO-AA	09
YAMATO-HAA	09
YAMATO-HNN	09
YAMATO-MBD	17
YAMATO-MBD PLUS	17
YAMATO-MND	17
YAMATO-MND PLUS	17
YAMATO-NN	09
YASUKA SLIDING	12



Company Highlights

Company

PT Chitose Internasional, Tbk

Business Line

Manufacturing

Head Office

Jl. Industri III No. 5 Utama
Cimahi 40533, Indonesia

Product Lines

Steel Chair Furnitures & Nursing Bed

Phone | Fax

+62 22 603 1900 | +62 22 603 1855

Product Categories

- Steel Furnitures
(Folding Chair, Folding Chair memo,
Hotel Restaurant & Food Court,
Office Chair, Meeting Chair)
& Nursing Bed
- Desk & Table
- Rack & Storage
- Lobby Space
- School
- Hospital Space

Marketing Office &
Distribution Center

Jl. HMS Mintaredja
Baros Cimahi 40521, Indonesia

Phone

+62 22 2066 4777

E-mail

ask@chitose-indonesia.com

Production Capacity

Steel Chair : 1.200.000 unit/years
Nursing Bed : 10.000 unit/years

Website

www.chitose-indonesia.com

Quality Standard

JIS, SNI, ISO 9001:2015

Year of Establishment

1979

Plant Area

About 25.200 m2

Year of Operation

1981

Building Area

About 17.400 m2

Employees

Aprox. 600 persons

