

Chitose[®]
Innovation by your inspiration



PRODUCT CATALOGUE 2018



Important Notice

- 01 All measurements given are approximate.
- 02 All dimensions are quotes in millimeter (mm).
- 03 Colours shown in this brochure may vary from the actual product.
- 04 The manufacturer reserves the right to change any specifications and design without prior notice due to continuing improvements.
- 05 Responsibility will not be taken if the product encounters any problem or damage due to abnormal usage, or if it has been tempered with.



Innovation by Your Inspiration

PT Chitose Internasional Tbk stands for innovations that are inspired by the users. We are driven by research and development, focusing on the growing need of furniture of Indonesia, yet also catering to demands from various parts of the world. Working in a simple and clean way, borderless, fair and decent, we strive to create a better life for all.

PT Chitose Internasional Tbk dengan bangga menghadirkan produk berkualitas hasil inovasi yang terinspirasi dari para penggunanya. Kami berkembang melalui riset yang tiada henti untuk memenuhi kebutuhan furnitur yang terus meningkat, baik dalam maupun di luar negeri. Dengan filosofi kerja "jujur, bersih, dan tanpa batas" kami berupaya menciptakan kesejahteraan bagi semua.

 **Folding Chair**



Yamato HAA/HNN	10
Yamato AA/NN	10
Yamato NP	11
Cosmo-541/542	11
Cosmo-941/942	12
CAL	12
Daishogun	13
Daishogun Plus	14
Daishogun UP	14
Yasuka Sliding	15

10-15

 **Folding Chair and memo**



Yamato MND	20
Yamato MBD	20
Yamato MND plus	20
Yamato MBD plus	20
Cosmo MNR	21
Cosmo MPR	21
Cosmo MNR plus	21
Cosmo MPR plus	21
Daishogun MUP	22
Daishogun LMUP	22
Cosmo LMPR	23

20-23

 **School**



Echool JP	28
Echool	29
Echool Plus	30
Manabu P JP	31
Manabu P	31
Manabu P Plus	32
Keiko JP / Keiko	33
Keiko FB	34
Keiko Plus	35
Ayumi	36
Echool Art	37
Manabu AH-01	38

Manabu AH-02	39
Uni Desk & Chair	40
TKG-01	41
TKG-02	42
Shiro WS-1224	43
Shiro WS-1218	43
Shiro-1224	43
Shiro-1218	43
Olive A-LM	43
Colour Box 89	44
Colour Box 35 D	44
Colour Box 35 S	44
Colour Box 35	44
Benkyo HSD-01	44
Duo Junior	45
Rack Junior	45

28-45

Hotel Banquet and restaurant

 **Hotel Banquet & Resto Chair**



Taro S	50
Hanako S	50
Jiro S	51
Caesar N/P	51
Prince	52
Sakata N	52
Callisto	53
Cavis	53
Olive A	54
Olive U	54
Sankei C-395	55
Glory	55
SAM	56
Flora H	56
Flora San	57
Ribbon P	57

50-57

 **Hotel Banquet & Resto Table**



Hobby Table T-1010	60
Table T-1010	60
Table T-7575	61
Coffee Table R-75	61
Coffee Table T-60	62
Coffee Table T-60 NE	62
Coffee Table T-60 PL	63
Table T-6012 Kotatsu	63
Coffee Table T-60 Kotatsu	64
FTC-6012	64
FTC-6018	65
FTC-6012 NE	65

60-65

Working and Meeting

 **Office Chair**



AJ Chair	70
CB Chair	71
Sylphy	72
Porus	72
Legno-203	73
Legno-201	73
Medix-611	74
Epo-530	74
Epo-330	75
Epo-130	76
ET-170	77
ET-171	77
Duo-01	78
Duo-02	78
ET D-500 / ET D-501	79
NBK	80
NA	80
NAN	80
NC	80
81T2	81
Fitto SW	81
Fitto FL	82
Fitto FL-A / Fitto FL-R	82
Sankei C-350 C	83
Sankei C-350	83

70-83

Meeting Chair



Olive SC	86
Olive DX	87
Fronty	88
Duo-03	88
Duo-04	89
Jasmine C-211	90
Jasmine C-111	91
Cozy	91
Yuki	92
Lotus	92
Fitto ST	93
Sankei C-371	93
Kasai	94
Leon	94
Vista N/P	95
Costa	95

86-95

Desk & Table



TKM-7012 W / TKM-7014	98
Manifold	99
SW	100
Flaptor	101
Wagon WKM-6040	102
TU-7014	102
TU-6012	103
TU-7575 P	103
T-7014 L/R	104
T-7014	104
T-7012	105
Wagon W-6040	105
HTU-6014	106
FTU-6018	106
Kumi MT	107
Kumi ED	107
Kumi MD	108
Kumi SD	108
Kumi FD	109
Kumi Wagon 2D	109
Kumi Wagon 3D	109

98-109

Rack & Storage



Inexto H-1800 SW	112
Inexto H-1320 SW/SL	112
Inexto H-1020 SW/SL	112
Inexto H-720	112
Inexto Locker 3D	113
Inexto Locker 4D	113
CK-810	114
CK-1800	114
Shelf 7012 / PS 7012 / base	114
Shelf 7090 / PS 7090 / base	115
Shelf 7070 / PS 7070 / base	115
Maple Rack L, M, S	116
Executive Rack L, M, S	118
Grey Rack L, M, S	118

112-119

Lobby Space



Fuji DS	122
Fuji SS	123
TU-6012 Low	124
Aso DS	124
Aso SS	125
T-5512	126
KT-01 Cavis	126
KT-02 Cavis	127
KT-02 Olive	128
ATC-01	128
Kogu KT-03	129
Kogu PC & PP (PU)	129
Kogu TS	129

122-129

Accessories



Trolley TM-01	131
Trolley TM-02	131
Trolley TF-01	131
Trolley TF-02	131

131

Hospital Space



CB-0733 T	136
CB-3300 D ST, D JP & T DX	140
CB-3003 D ST, D JP & D DX	142
CB-3012 D ST, D JP & D4 DX	144
CB-3011 D ST, D JP & D DX	146
CB-135 D ST & D JP	148
CB 535 D ST	148
CB-7003 D (Wider Bed)	150
CB-7012 D (Wider Bed)	150
CB-7011 D (Wider Bed)	150
CB-003 Stretcher	151
CB-002	152
CB-001	153
CB-501 (Wire Mesh)	153
CB-005 (Baby Cot)	154
CB-005 D (Baby Cot 2 Lock)	154
CB-004 Ex (Examination Bed - Flat)	154
CB-004 Ex G (Examination Bed - Gear)	154
ST (H/F Board)	156
ST DB (H/F Board)	156
ST LG (H/F Board)	156
DX (H/F Board)	156
DX DB (H/F Board)	156
DX LG (H/F Board)	157
JP (H/F Board)	157
MT-001 S (Mattress - Standard)	158
MT-001 W (Mattress - Wider)	158
MT-002 S (Mattress - Standard)	158
MT-002 W (Mattress - Wider)	158
MT-003 S (Mattress - Standard)	158
MT-003 W (Mattress - Wider)	158
MT-004 S (Mattress - Standard)	158
CSR-001	159
CSR-002	159
CSR-003	159
FSR-001 (Folding Side Rail)	159
HR-001 (Irrigator Bar)	160
TB-001 (Table Panel)	160
FS-001 (Foot Step)	160
TB-002 (Bed Side Table)	161
CBC-002 (Bed Side Cabinet)	161

136-161

Colour Sample	162
Quality Assurance	164
Index	165
Company Highlights	167





REDIFINING QUALITY





Yamato HAA/HNN

10



Yamato AA/NN

10



Yamato NP

11



Cosmo-541/542

11



Cosmo-941/942

12



CAL

12



Daishogun

13



Daishogun Plus

14



Daishogun UP

14



Yasuka Sliding

15

YAMATO HAA/HNN



Yamato-HNN



Yamato-HAA

PRODUCT SPECIFICATIONS

Dimension W x D x H (mm)	449 X 527 X 807
Weight per Piece (kg)	4.6
Contain per Carton	5
Frame Finishing	Chrome Plating, Powder Coating (HNN Seat Plate)
Frame Colour	Chrome

COLOUR OPTIONS & UPHOLSTERY MATERIAL



PRODUCT DIMENSION

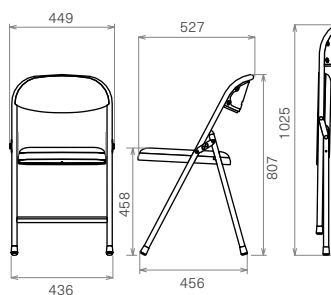

PRODUCT SPECIFICATIONS

Dimension W x D x H (mm)	449 X 513 X 823
Weight per Piece (kg)	4.6 (AA) 4.8 (NN)
Contain per Carton	5
Frame Finishing	Chrome Plating, Powder Coating (NN Seat Plate)
Frame Colour	Chrome

COLOUR OPTIONS & UPHOLSTERY MATERIAL

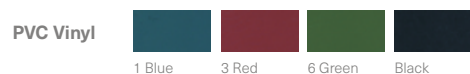

PRODUCT DIMENSION

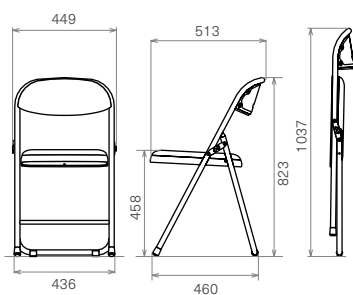

YAMATO AA/NN



Yamato-NN



YAMATO NP



PRODUCT SPECIFICATIONS

Dimension W x D x H (mm)	449 X 513 X 823
Weight per Piece (kg)	4.8
Contain per Carton	5
Frame Finishing	Chrome Plating, Powder Coating (NP Seat Plate)
Frame Colour	Chrome

COLOUR OPTIONS & UPHOLSTERY MATERIAL



PRODUCT DIMENSION

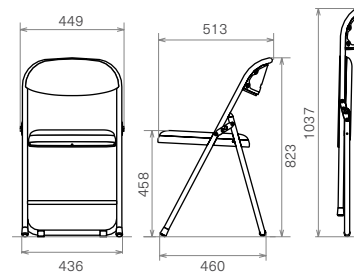

PRODUCT SPECIFICATIONS

Dimension W x D x H (mm)	460 X 446 X 773
Weight per Piece (kg)	4.4
Contain per Carton	5
Frame Finishing	Powder Coating (542)
Frame Colour	Chrome (541)

COLOUR OPTIONS & UPHOLSTERY MATERIAL

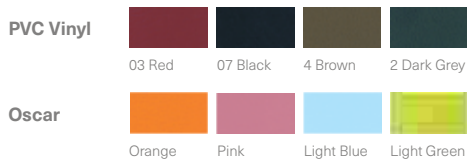

PRODUCT DIMENSION

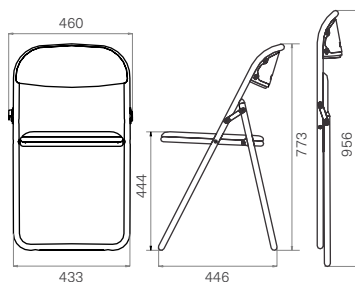

COSMO -541/542



Cosmo-541



Cosmo-542

COSMO-941/942



Cosmo-941



Cosmo-942



Cosmo-941

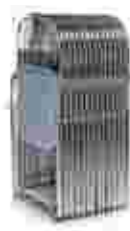

PRODUCT SPECIFICATIONS

Dimension W x D x H (mm)	490 X 449 X 778
Weight per Piece (kg)	4.8
Contain per Carton	5
Frame Finishing	Nickel Chrome (941), Powder Coating (942)
Frame Colour	Chrome (941), Silver (942)

COLOUR OPTIONS & UPHOLSTERY MATERIAL

PVC Vinyl			
	Red	Blue	
Oscar			
	Navy Blue	Brown	Black



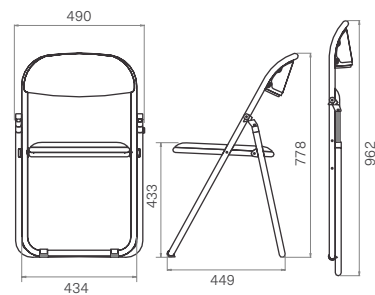



PRODUCT DIMENSION



PRODUCT SPECIFICATIONS

Dimension W x D x H (mm)	450 X 495 X 783
Weight per Piece (kg)	4.1
Contain per Carton	4
Frame Finishing	Powder Coating
Frame Colour	Silver

COLOUR OPTIONS & UPHOLSTERY MATERIAL

Fabric				
	L1 Blue	L2 Grey	L6 Green	L7 Black
				
	N3 Red	N4 Brown	N5 Cream	

PRODUCT DIMENSION

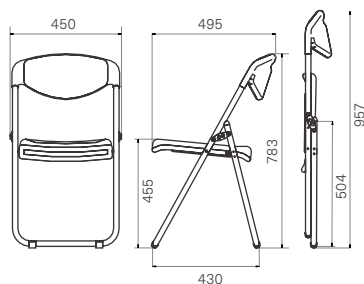

CAL (CHITOSE ALUMINIUM)

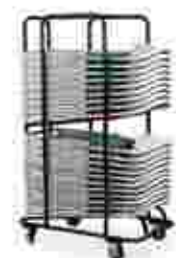

DAISHOGUN



PRODUCT SPECIFICATIONS

Dimension W x D x H (mm)	449 X 493 X 807
Weight per Piece (kg)	4.4
Contain per Carton	4
Frame Finishing	Powder Coating
Frame Colour	Light Grey

COLOUR OPTIONS & UPHOLSTERY MATERIAL



PRODUCT DIMENSION

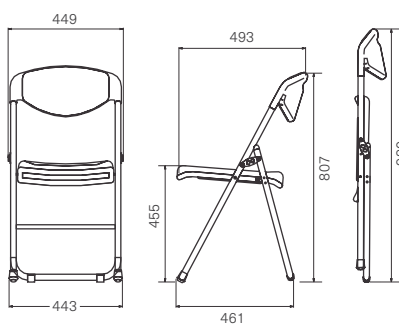

CAL (Chitose Aluminium)

DAISHOGUN PLUS



PRODUCT SPECIFICATIONS

Dimension W x D x H (mm)	465 X 466 X 814
Weight per Piece (kg)	4.4
Contain per Carton	4
Frame Finishing	Powder Coating
Frame Colour	Grey

COLOUR OPTIONS & UPHOLSTERY MATERIAL

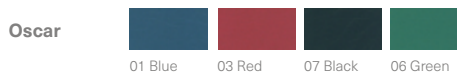

PRODUCT DIMENSION

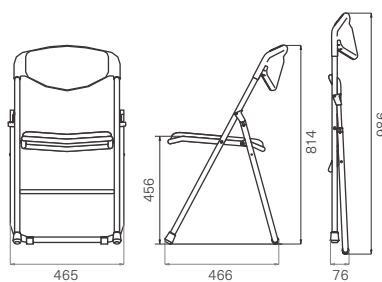

PRODUCT SPECIFICATIONS

Dimension W x D x H (mm)	450 X 500 X 810
Weight per Piece (kg)	4.4
Contain per Carton	4
Frame Finishing	Powder Coating
Frame Colour	Grey

COLOUR OPTIONS & UPHOLSTERY MATERIAL

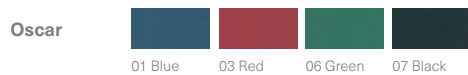

PRODUCT DIMENSION

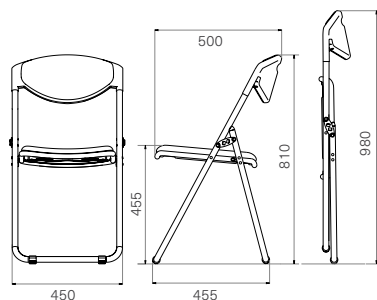

DAISHOGUN UP



YASUKA SLIDING



PRODUCT SPECIFICATIONS

Dimension W x D x H (mm)	417 X 434 X 744
Weight per Piece (kg)	3.9
Contain per Carton	6
Frame Finishing	Chrome Plating
Frame Colour	Chrome

COLOUR OPTIONS & UPHOLSTERY MATERIAL

PVC Vinyl				
	1 Blue	3 Red	6 Green	7 Black

PRODUCT DIMENSION

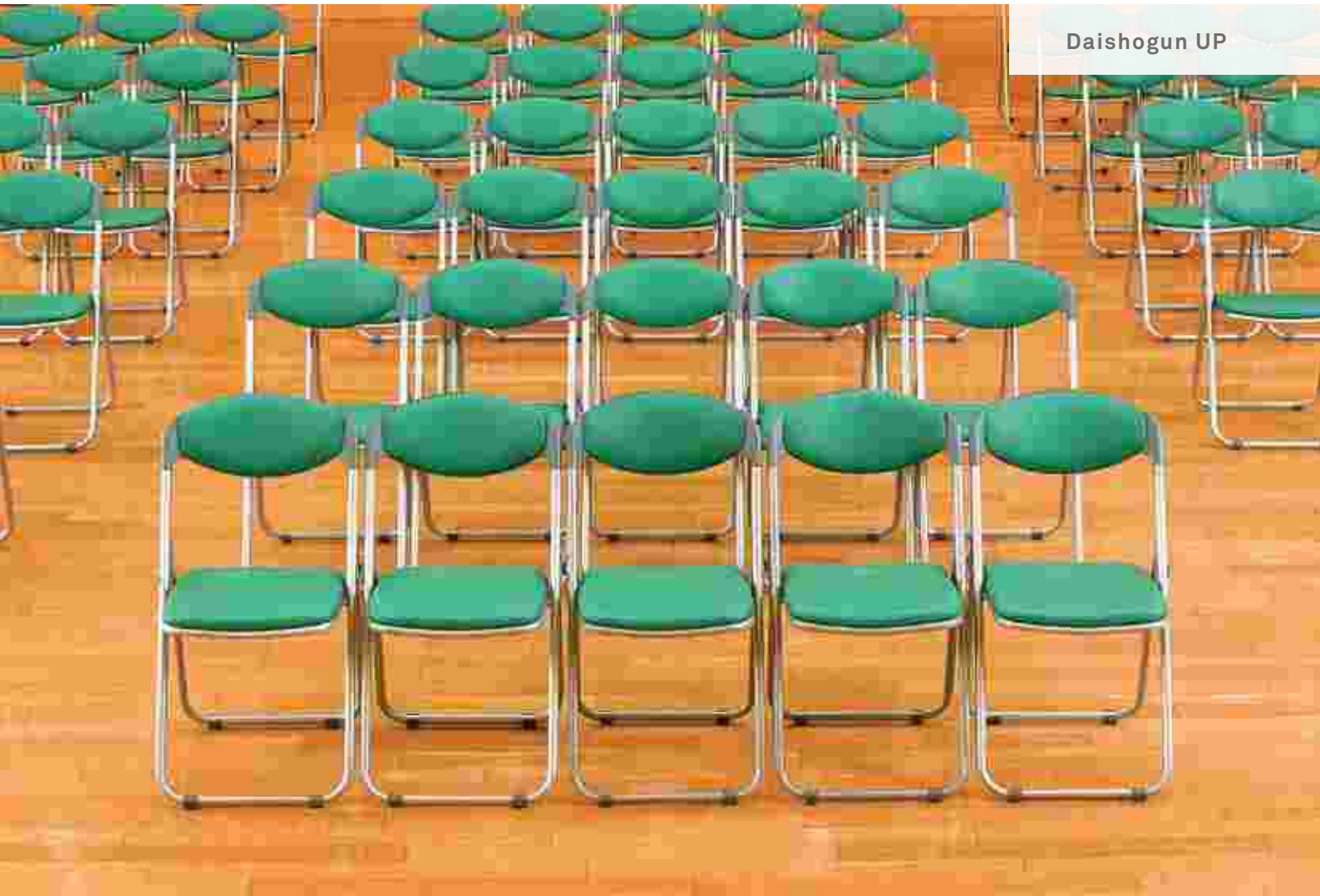
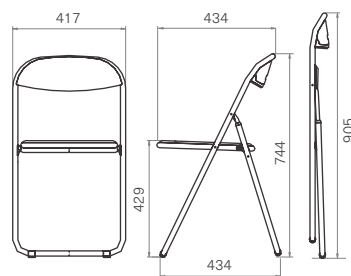

Daishogun UP





DELICATE CREATION





Yamato MND
20



Yamato MBD
20



Yamato MND Plus
20



Yamato MBD Plus
20



Cosmo MNR
21



Cosmo MPR
21



Cosmo MNR Plus
21



Cosmo MPR Plus
21



Daishogun MUP
22



Daishogun LMUP
22



Cosmo LMPR
23



YAMATO MND/MBD



Yamato MBD



Yamato MND



PRODUCT SPECIFICATIONS

Dimension W x D x H (mm)	436 X 732 X 778 H
Weight per Piece (kg)	6.7
Contain per Carton	2
Memo Table Material	Plywood
Frame Finishing	Chrome Plating (MND), Powder Coating (MBD)
Frame Colour	Chrome, Black

COLOUR OPTIONS & UPHOLSTERY MATERIAL

PVC

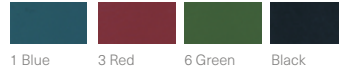

PRODUCT DIMENSION

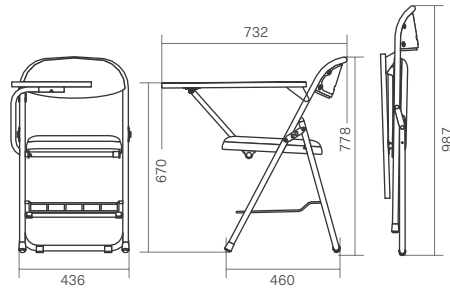

PRODUCT SPECIFICATIONS

Dimension W x D x H (mm)	436 X 732 X 778
Weight per Piece (kg)	6.0
Contain per Carton	2
Memo Table Material	Plastic
Frame Finishing	Chrome Plating (MND Plus) Powder Coating (MBD Plus)
Frame Colour	Chrome, Black

COLOUR OPTIONS & UPHOLSTERY MATERIAL

PVC



Plastic

(Memo Table)



* Memo Table Made of High Quality Plastic

PRODUCT DIMENSION

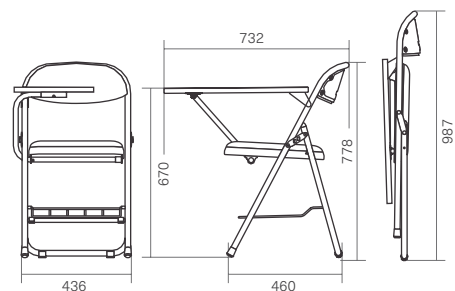

YAMATO MND/MBD PLUS



* Memo Table Made of High Quality Plastic

Yamato MBD Plus



Yamato MND Plus

COSMO MNR/MPR



Cosmo MNR



Cosmo MPR

PRODUCT SPECIFICATIONS

Dimension W x D x H (mm)	471 X 714 X 771
Weight per Piece (kg)	6.0
Contain per Carton	2
Memo Table Material	Plywood
Frame Finishing	Chrome Plating (MNR), Powder Coating (MPR)
Frame Colour	Chrome, Silver

COLOUR OPTIONS & UPHOLSTERY MATERIAL

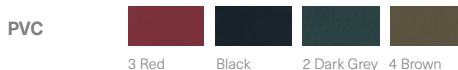

PRODUCT DIMENSION

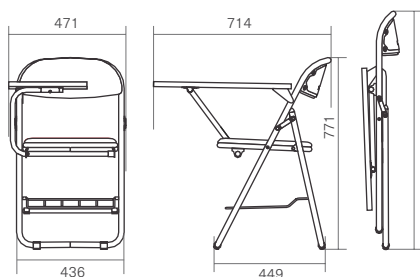

PRODUCT SPECIFICATIONS

Dimension W x D x H (mm)	471 X 714 X 771
Weight per Piece (kg)	6.0
Contain per Carton	2
Memo Table Material	Plastic
Frame Finishing	Chrome Plating (MNR Plus) Powder Coating (MPR Plus)
Frame Colour	Chrome, Silver

COLOUR OPTIONS & UPHOLSTERY MATERIAL

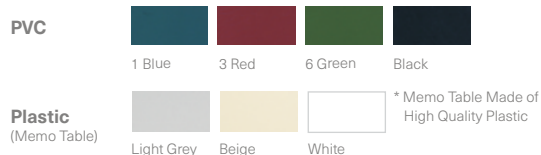

PRODUCT DIMENSION

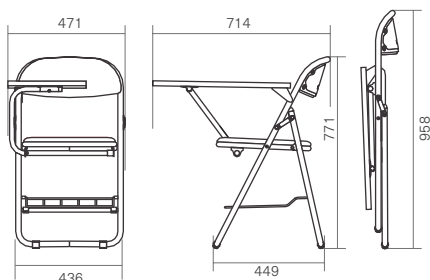

COSMO MNR/MPR PLUS



Cosmo MPR Plus



Cosmo MNR Plus



DAISHOGUN MUP

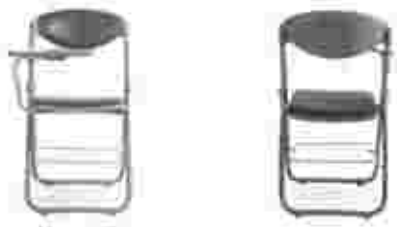

PRODUCT SPECIFICATIONS

Dimension W x D x H (mm)	430 X 455 X 809
Weight per Piece (kg)	6.0
Contain per Carton	2
Memo Table Material	Plywood
Frame Finishing	Powder Coating
Frame Colour	Grey

COLOUR OPTIONS & UPHOLSTERY MATERIAL

PVC 
Black

PRODUCT DIMENSION

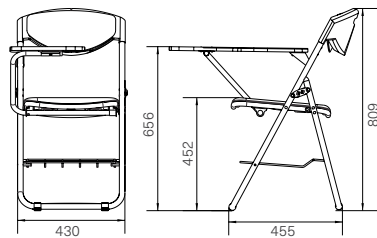

PRODUCT SPECIFICATIONS

Dimension W x D x H (mm)	430 X 456 X 809
Weight per Piece (kg)	7.4
Contain per Carton	2
Memo Table Material	Particle Board
Frame Finishing	Powder Coating
Frame Colour	Chrome, Black

DAISHOGUN LMUP



Large Memo Table

COLOUR OPTIONS & UPHOLSTERY MATERIAL

PVC 
Black

PRODUCT DIMENSION

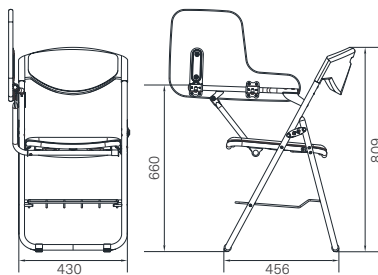

COSMO LMPR



Large Memo Table



PRODUCT SPECIFICATIONS

Dimension W x D x H (mm)	430 X 456 X 814
Weight per Piece (kg)	7.1
Contain per Carton	2
Memo Table Material	Particle Board
Frame Finishing	Powder Coating
Frame Colour	Silver

COLOUR OPTIONS & UPHOLSTERY MATERIAL



PRODUCT DIMENSION

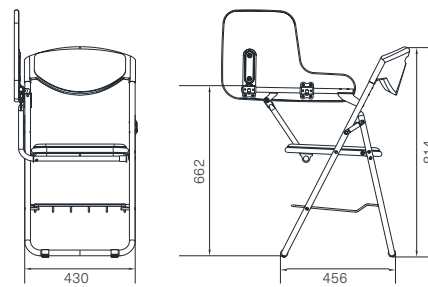





ENJOYABLE LESSON

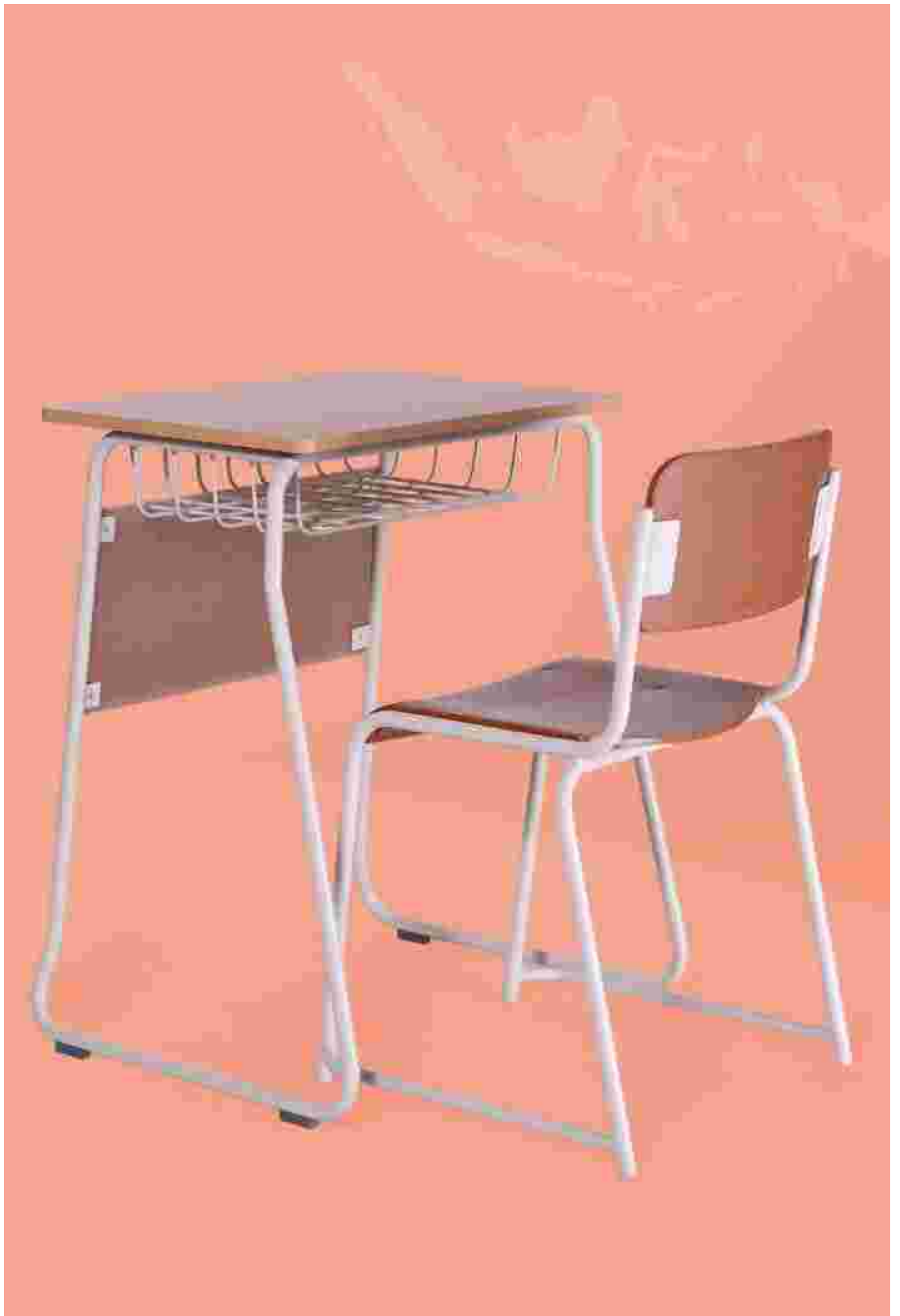



Echool JP
28



Echool
29



Echool Plus
30



Manabu P JP / Manabu P
31



Manabu P Plus
32



Keiko JP / Keiko
33



Keiko FB
34



Keiko Plus
35



Ayumi
36



Echool Art
37



Manabu AH-01
38



Manabu AH-02
39



Uni Desk & Uni Chair
40



TKG-01
41



TKG-02
42



Shiro WS 1224/1218
Shiro 1224/1218
43



OLIVE A-LM
43



Colour Box
44



Benkyo HSD-01
Duo Junior & Rack Junior
44 - 45

ECHOOL JP



2 113-126 cm

3 127-141 cm

4 142-156 cm

5 157-172 cm

6 173-180 cm

PRODUCT SPECIFICATIONS

TABLE

Dimension W x D x H (mm)	650 X 450 X 525 (No.2) 650 X 450 X 585 (No.3) 650 X 450 X 645 (No.4) 650 X 450 X 705 (No.5) 650 X 450 X 765 (No.6)
Weight per Piece (kg)	6.4 / 6.6 / 6.8 / 7.0 / 7.15
Contain per Carton	4
Table Top Material	Plywood
Drawer Material	Plastic
Frame Finishing	Powder Coating
Frame Colour	Ivory

CHAIR

Dimension (mm)	420 X 362 X 570 (No.2) 420 X 368 X 640 (No.3) 420 X 394 X 685 (No.4) 420 X 420 X 740 (No.5) 420 X 441 X 830 (No.6)
Weight per Piece (kg)	3.3 / 3.5 / 3.6 / 3.8 / 4.3
Contain per Carton	4
Frame Colour	Ivory
Seat & Back Material	Plywood
Frame Finishing	Powder Coating

SIZE

Table Height	Person Height	Range Height	Label
525 mm	120 cm	113-126 cm	2 113-126 cm
585 mm	135 cm	127-141 cm	3 127-141 cm
645 mm	150 cm	142-156 cm	4 142-156 cm
705 mm	165 cm	157-172 cm	5 157-172 cm
765 mm	180 cm	173-180 cm	6 173-180 cm

PRODUCT DIMENSION

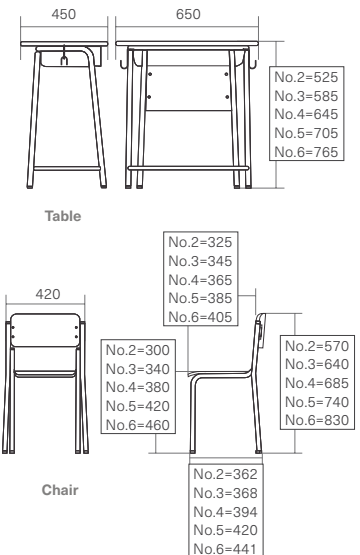

ECHOOL



PRODUCT SPECIFICATIONS

TABLE

Dimension W x D x H (mm)	650 X 450 X 525 (No.2) 650 X 450 X 585 (No.3) 650 X 450 X 645 (No.4) 650 X 450 X 705 (No.5) 650 X 450 X 765 (No.6)
Weight per Piece (kg)	6.4 / 6.6 / 6.8 / 7.0 / 7.15
Contain per Carton	4
Table Top Material	Plywood
Drawer Material	Plastic
Frame Colour	Ivory
Frame Finishing	Powder Coating

CHAIR

Dimension (mm)	420 X 362 X 570 (No.2) 420 X 368 X 640 (No.3) 420 X 394 X 685 (No.4) 420 X 420 X 740 (No.5) 420 X 441 X 830 (No.6)
Weight per Piece (kg)	3.3 / 3.5 / 3.6 / 3.8 / 4.3
Contain per Carton	4
Frame Colour	Ivory
Seat & Back Material	Plywood
Frame Finishing	Powder Coating

SIZE

Table Height	Person Height	Range Height	Label
525 mm	120 cm	113-126 cm	2 113-126 cm
585 mm	135 cm	127-141 cm	3 127-141 cm
645 mm	150 cm	142-156 cm	4 142-156 cm
705 mm	165 cm	157-172 cm	5 157-172 cm
765 mm	180 cm	173-180 cm	6 173-180 cm

PRODUCT DIMENSION

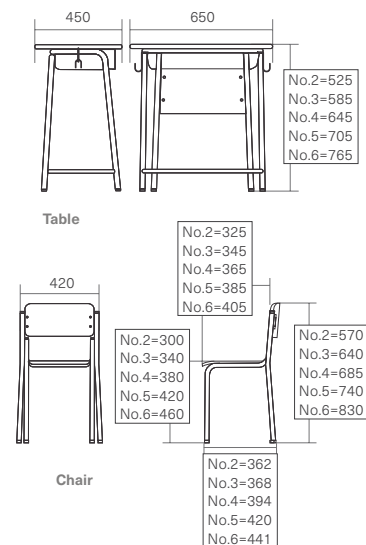

ECHOOL PLUS



2 113-126 cm

3 127-141 cm

4 142-156 cm

5 157-172 cm

6 173-180 cm

PRODUCT SPECIFICATIONS

TABLE

Dimension W x D x H (mm)	650 X 450 X 535 (No.2) 650 X 450 X 595 (No.3) 650 X 450 X 655 (No.4) 650 X 450 X 715 (No.5) 650 X 450 X 775 (No.6)
Weight per Piece (kg)	3.8 / 3.9 / 4.0 / 4.2 / 4.3
Contain per Carton	4
Table Top Material	Plastic
Drawer Material	Plastic
Front Board Material	Plastic
Frame Finishing	Powder Coating
Frame Colour	Ivory

CHAIR

Dimension (mm)	420 X 362 X 570 (No.2) 420 X 368 X 640 (No.3) 420 X 394 X 685 (No.4) 420 X 420 X 740 (No.5) 420 X 441 X 830 (No.6)
Weight per Piece (kg)	2.6 / 2.6 / 2.9 / 3.2 / 3.3
Contain per Carton	4
Seat & Back Material	Plastic
Frame Finishing	Powder Coating
Frame Colour	Ivory

SIZE

Table Height	Person Height	Range Height	Label
535 mm	120 cm	113-126 cm	2 113-126 cm
595 mm	135 cm	127-141 cm	3 127-141 cm
655 mm	150 cm	142-156 cm	4 142-156 cm
715 mm	165 cm	157-172 cm	5 157-172 cm
775 mm	180 cm	173-180 cm	6 173-180 cm

PRODUCT DIMENSION

* Seat, Back, Table Top and Front Board Made of High Quality Plastic

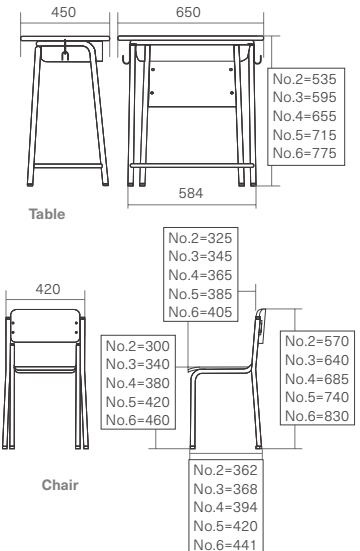

MANABU P JP / MANABU P



Manabu P



Manabu P JP



4 142-156 cm



5 157-172 cm



6 173-180 cm

PRODUCT SPECIFICATIONS

TABLE

Dimension W x D x H (mm)	650 X 450 X 640 (No.4) 650 X 450 X 700 (No.5) 650 X 450 X 760 (No.6)
Weight per Piece (kg)	8.4 / 8.5 / 8.57
Contain per Carton	4
Table Top Material	Particle Board (P), Plywood (JP)
Drawer Material	Astal
Frame Colour	Ivory
Frame Finishing	Powder Coating

CHAIR

Dimension (mm)	462 X 434 X 750 (No.4) 462 X 438 X 790 (No.5) 462 X 441 X 830 (No.6)
Weight per Piece (kg)	3.0 / 3.6 / 4.2
Contain per Carton	4
Frame Colour	Ivory
Frame Finishing	Powder Coating

SIZE

Table Height	Person Height	Range Height	Label
640 mm	150 cm	142-156 cm	4 142-156 cm
700 mm	165 cm	157-172 cm	5 157-172 cm
760 mm	180 cm	173-180 cm	6 173-180 cm

SEAT - BACK MATERIAL & COLOURS



PRODUCT DIMENSION

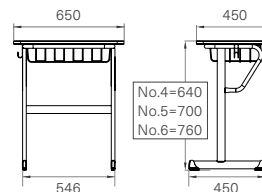

Table

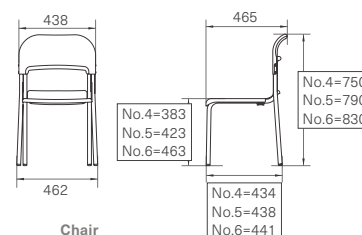

Chair

MANABU P PLUS

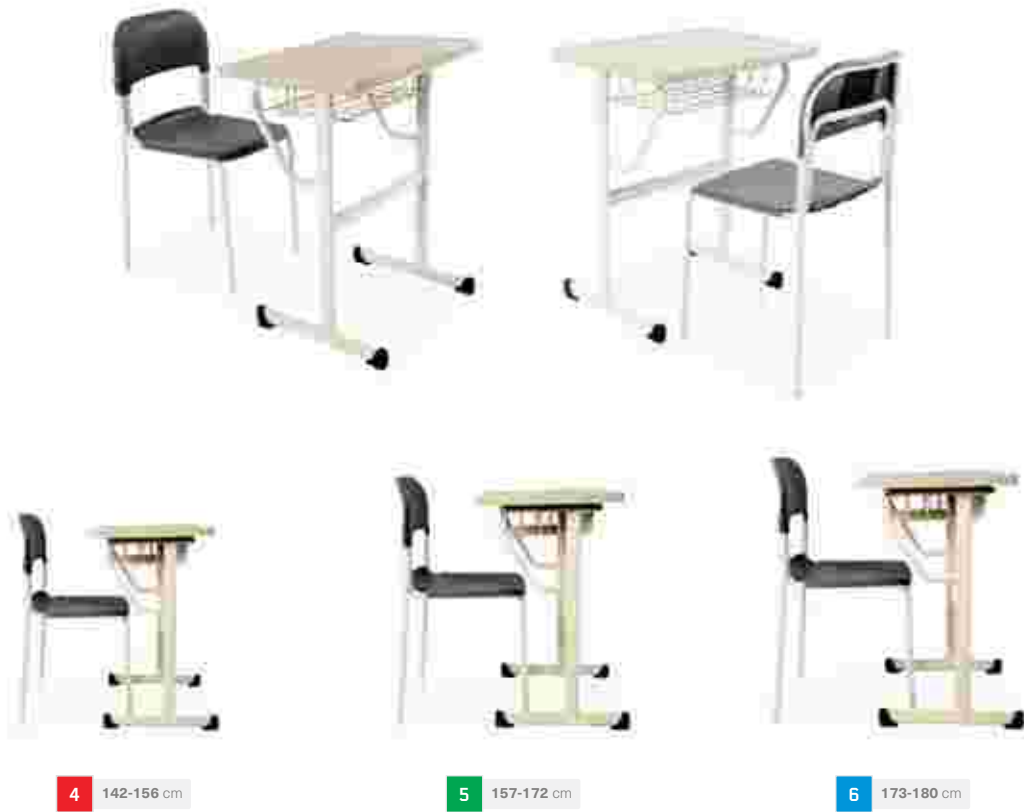

PRODUCT SPECIFICATIONS

TABLE

Dimension W x D x H (mm)	650 X 450 X 651 (No.4) 650 X 450 X 711 (No.5) 650 X 450 X 771 (No.6)
Weight per Piece (kg)	8.4 / 8.53 / 8.57
Contain per Carton	4
Table Top Material	Plastic
Drawer Material	Astal
Frame Colour	Ivory
Frame Finishing	Powder Coating

SIZE

Table Height	Person Height	Range Height	Label
651 mm	150 cm	142-156 cm	4 142-156 cm
711 mm	165 cm	157-172 cm	5 157-172 cm
771 mm	180 cm	173-180 cm	6 173-180 cm

SEAT - BACK MATERIAL & COLOURS



PRODUCT DIMENSION

* Seat, Back, Table Top and Front Board Made of High Quality Plastic

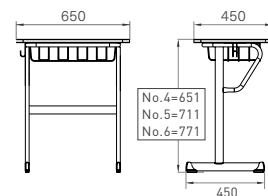

Table

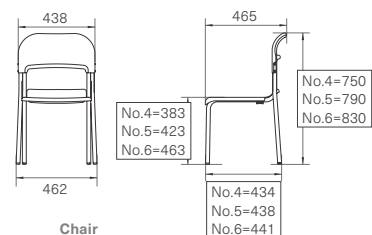

Chair

CHAIR

Dimension (mm)	462 X 434 X 750 (No.4) 462 X 438 X 790 (No.5) 462 X 441 X 830 (No.6)
Weight per Piece (kg)	3.0 / 3.6 / 4.2
Contain per Carton	4
Frame Colour	Ivory
Frame Finishing	Powder Coating

KEIKO JP / KEIKO



Keiko



Keiko JP



4 142-156 cm



5 157-172 cm



6 173-180 cm

PRODUCT SPECIFICATIONS

TABLE

Dimension W x D x H (mm)	650 X 450 X 640 (No.4) 650 X 450 X 700 (No.5) 650 X 450 X 760 (No.6)
Weight per Piece (kg)	7.59 / 7.63 / 7.67
Contain per Carton	4
Table Top Material	Particle Board, Plywood (JP)
Drawer Material	Astal
Frame Colour	Ivory
Frame Finishing	Powder Coating

CHAIR

Dimension (mm)	462 X 434 X 750 (No.4) 462 X 438 X 790 (No.5) 462 X 441 X 830 (No.6)
Weight per Piece (kg)	3.0 / 3.6 / 4.2
Contain per Carton	4
Frame Colour	Ivory
Frame Finishing	Powder Coating

SIZE

Table Height	Person Height	Range Height	Label
640 mm	150 cm	142-156 cm	4 142-156 cm
700 mm	165 cm	157-172 cm	5 157-172 cm
760 mm	180 cm	173-180 cm	6 173-180 cm

SEAT - BACK MATERIAL & COLOURS



PRODUCT DIMENSION

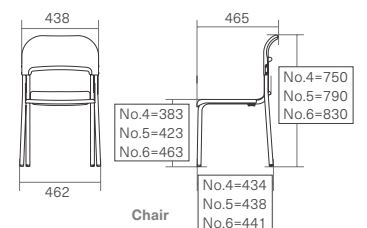
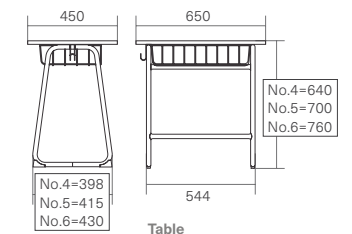

KEIKO FB



4 142-156 cm

5 157-172 cm

6 173-180 cm

PRODUCT SPECIFICATIONS

TABLE

Dimension W x D x H (mm)	650 X 450 X 640 (No.4) 650 X 450 X 700 (No.5) 650 X 450 X 760 (No.6)
Weight per Piece (kg)	8.0 / 8.15 / 8.3
Contain per Carton	4
Table Top Material	Plywood
Drawer Material	Astal
Frame Colour	Ivory
Frame Finishing	Powder Coating

SIZE

Table Height	Person Height	Range Height	Label
640 mm	150 cm	142-156 cm	4 142-156 cm
700 mm	165 cm	157-172 cm	5 157-172 cm
760 mm	180 cm	173-180 cm	6 173-180 cm

SEAT - BACK MATERIAL & COLOURS

Plastic



PRODUCT DIMENSION

CHAIR

Dimension (mm)	462 X 434 X 750 (No.4) 462 X 438 X 790 (No.5) 462 X 441 X 830 (No.6)
Weight per Piece (kg)	3.0 / 3.6 / 4.2
Contain per Carton	4
Frame Colour	Ivory
Frame Finishing	Powder Coating

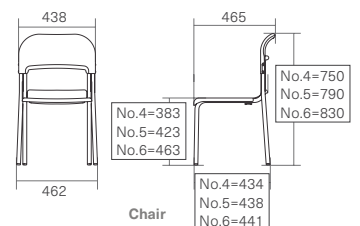
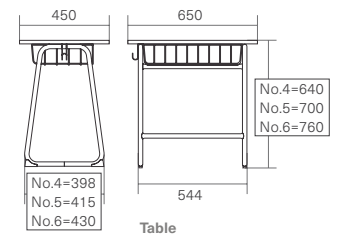

KEIKO PLUS



4 142-156 cm

5 157-172 cm

6 173-180 cm

PRODUCT SPECIFICATIONS

TABLE

Dimension W x D x H (mm)	650 X 450 X 646 (No.4) 650 X 450 X 706 (No.5) 650 X 450 X 766 (No.6)
Weight per Piece (kg)	7.59 / 7.63 / 7.67
Contain per Carton	4
Table Top Material	Plastic
Drawer Material	Astal
Frame Colour	Ivory
Frame Finishing	Powder Coating

SIZE

Table Height	Person Height	Range Height	Label
646 mm	150 cm	142-156 cm	4 142-156 cm
706 mm	165 cm	157-172 cm	5 157-172 cm
766 mm	180 cm	173-180 cm	6 173-180 cm

SEAT - BACK MATERIAL & COLOURS



CHAIR

Dimension (mm)	462 X 434 X 750 (No.4) 462 X 438 X 790 (No.5) 462 X 441 X 830 (No.6)
Weight per Piece (kg)	3.0 / 3.6 / 4.2
Contain per Carton	4
Frame Colour	Ivory
Frame Finishing	Powder Coating

PRODUCT DIMENSION

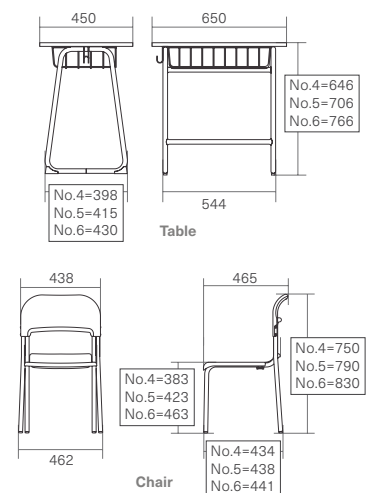

AYUMI



4 142-156 cm

5 157-172 cm

6 173-180 cm

PRODUCT SPECIFICATIONS

TABLE

Dimension W x D x H (mm)	600 X 498 X 640 (No.4) 600 X 519 X 700 (No.5) 600 X 540 X 760 (No.6)
Weight per Piece (kg)	6.43 / 6.47 / 6.74
Contain per Carton	4
Table Top Material	Particle Board
Frame Colour	Ivory
Frame Finishing	Powder Coating

SIZE

Table Height	Person Height	Range Height	Label
640 mm	150 cm	142-156 cm	4 142-156 cm
700 mm	165 cm	157-172 cm	5 157-172 cm
760 mm	180 cm	173-180 cm	6 173-180 cm

SEAT - BACK MATERIAL & COLOURS

Plastic



CHAIR

Dimension (mm)	495 X 403 X 690 (No.4) 495 X 448 X 730 (No.5) 495 X 463 X 770 (No.6)
Weight per Piece (kg)	3.2 / 3.27 / 3.36
Contain per Carton	4
Seat & Back Material	Plastic
Frame Colour	Ivory
Frame Finishing	Powder Coating

PRODUCT DIMENSION

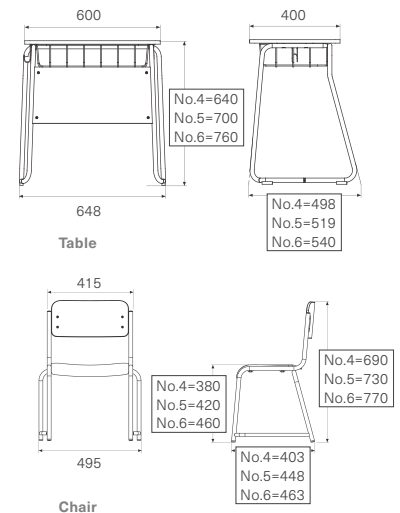

ECHOOL ART



PRODUCT SPECIFICATIONS

TABLE

Dimension W x D x H (mm)	852 X 450 X 754
Weight per Piece (kg)	10
Contain per Carton	1
Top & Side Table Material	Plywood
Frame Colour	Silver
Frame Finishing	Powder Coating

PRODUCT DIMENSION

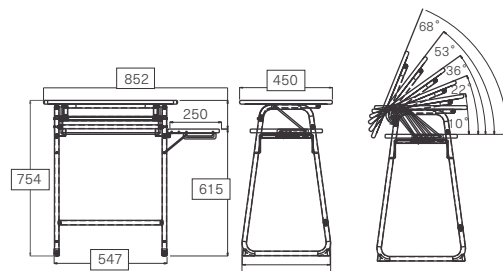

Table

CHAIR (Echool plus no. 6)

Dimension (mm)	420 X 441 X 830
Weight per Piece (kg)	3.3
Contain per Carton	1
Seat & Back Material	Plastic
Frame Colour	Silver
Frame Finishing	Powder Coating

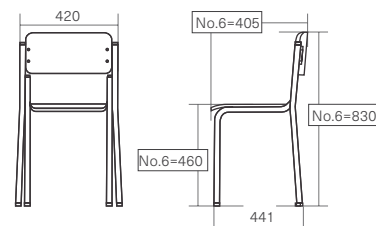

Chair

MANABU AH-01



Chair & Table : Adjustable Height Level



3 127-141 cm



4 142-156 cm



5 157-172 cm



6 173-180 cm

PRODUCT SPECIFICATIONS

TABLE

Dimension W x D x H (mm)	650 X 450 X 580 (No.3) 650 X 450 X 640 (No.4) 650 X 450 X 700 (No.5) 650 X 450 X 760 (No.6)
Weight per Piece (kg)	11
Contain per Carton	4
Table Top Material	Plywood
Frame Colour	Ivory
Frame Finishing	Powder Coating

SIZE

Table Height	Person Height	Range Height	Label
580 mm	135 cm	127-141 cm	3 127-141 cm
640 mm	150 cm	142-156 cm	4 142-156 cm
700 mm	165 cm	157-172 cm	5 157-172 cm
760 mm	180 cm	173-180 cm	6 173-180 cm

CHAIR

Dimension (mm)	360 X 440 X 650 (No.3) 360 X 440 X 690 (No.4) 360 X 440 X 730 (No.5) 360 X 440 X 770 (No.6)
Weight per Piece (kg)	6.7
Contain per Carton	4
Seat & Back Material	Plywood
Frame Colour	Ivory
Frame Finishing	Powder Coating

PRODUCT DIMENSION

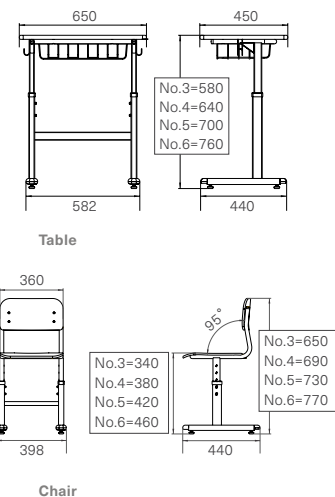

MANABU AH-02



Chair & Table : Adjustable Height Level



3 127-141 cm

4 142-156 cm

5 157-172 cm

6 173-180 cm

PRODUCT SPECIFICATIONS

TABLE

Dimension W x D x H (mm)	1200 X 450 X 580 (No.3) 1200 X 450 X 640 (No.4) 1200 X 450 X 700 (No.5) 1200 X 450 X 760 (No.6)
Weight per Piece (kg)	13.5
Contain per Carton	4
Table Top Material	Plywood
Frame Colour	Ivory
Frame Finishing	Powder Coating

SIZE

Table Height	Person Height	Range Height	Label
580 mm	135 cm	127-141 cm	3 127-141 cm
640 mm	150 cm	142-156 cm	4 142-156 cm
700 mm	165 cm	157-172 cm	5 157-172 cm
760 mm	180 cm	173-180 cm	6 173-180 cm

CHAIR

Dimension (mm)	360 X 440 X 650 (No.3) 360 X 440 X 690 (No.4) 360 X 440 X 730 (No.5) 360 X 440 X 770 (No.6)
Weight per Piece (kg)	6.7
Contain per Carton	4
Seat & Back Material	Plywood
Frame Colour	Ivory
Frame Finishing	Powder Coating

PRODUCT DIMENSION

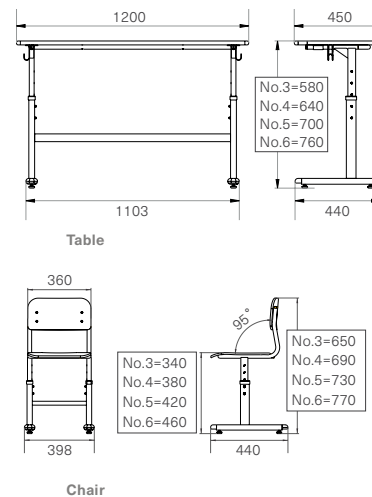

UNI DESK & CHAIR (HIGH & LOW)



PRODUCT SPECIFICATIONS

UNI DESK (High & Low)

Dimension W x D x H (mm)	1290 X 400 X 700 (High) 1290 X 400 X 600 (Low)
Weight per Piece (kg)	11.30 (High) / 11.10 (Low)
Contain per Carton	1
Table Top Material	Plywood
Frame Colour	Silver
Frame Finishing	Powder Coating

PRODUCT DIMENSION

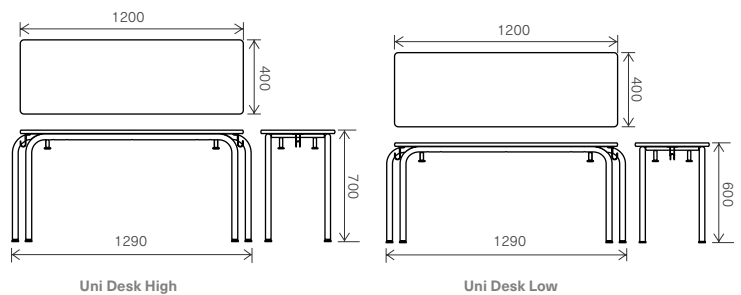

CHAIR (High & Low)

Dimension (mm)	450 X 385 X 738 (High) 437 X 345 X 640 (Low)
Contain per Carton	4
Seat & Back Material	Plywood
Frame Colour	Ivory
Frame Finishing	Powder Coating

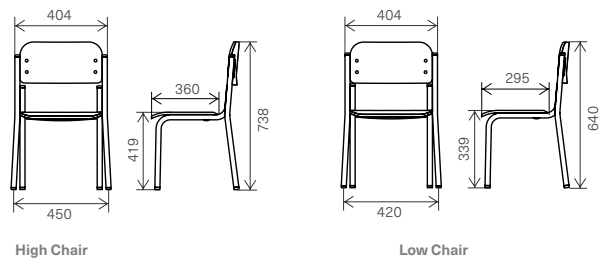

TKG-01



PRODUCT SPECIFICATIONS

TABLE

Dimension W x D x H (mm)	1200 X 550 X 450
Weight per Piece (kg)	25
Contain per Carton	1
Frame Colour	Ivory, Yellow, Light Blue
Frame Finishing	Powder Coating

CHAIR (Echool Plus 2)

Dimension (mm)	420 X 362 X 570
Weight per Piece (kg)	2.6
Contain per Carton	4
Seat & Back Material	Plastic
Frame Colour	Ivory, Yellow, Light Blue
Frame Finishing	Powder Coating

TABLE TOP MATERIAL & COLOURS

Particle Board covered with PVC



PRODUCT DIMENSION

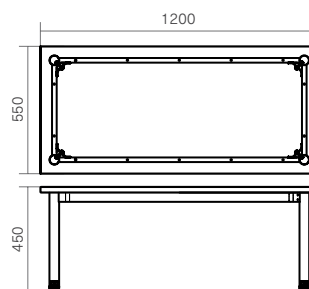

Table

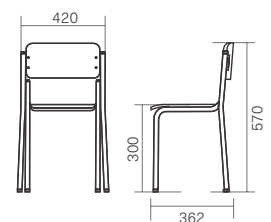

Chair

TKG-02



Stackable
(max 3 levels)



PRODUCT SPECIFICATIONS

TABLE

Dimension W x D x H (mm)	1284 X 600 X 520
Weight per Piece (kg)	13.6
Contain per Carton	2
Frame Colour	Silver
Frame Finishing	Powder Coating

CHAIR (Echool Plus 2)

Dimension (mm)	420 X 362 X 570
Weight per Piece (kg)	2.6
Contain per Carton	4
Seat & Back Material	Plastic
Frame Colour	Silver
Frame Finishing	Powder Coating

TABLE TOP MATERIAL & COLOURS

Particle Board + MDF



PRODUCT DIMENSION

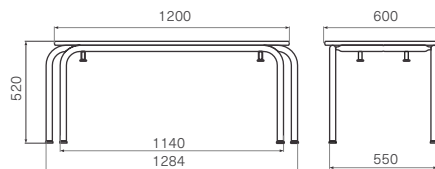

Table

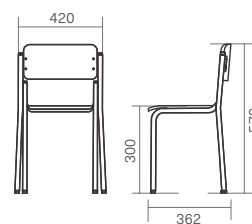

Chair

**SHIRO WS-1224 /
SHIRO WS-1218 (WITH LEG)
SHIRO-1224 /
SHIRO-1218 (WITHOUT LEG)**

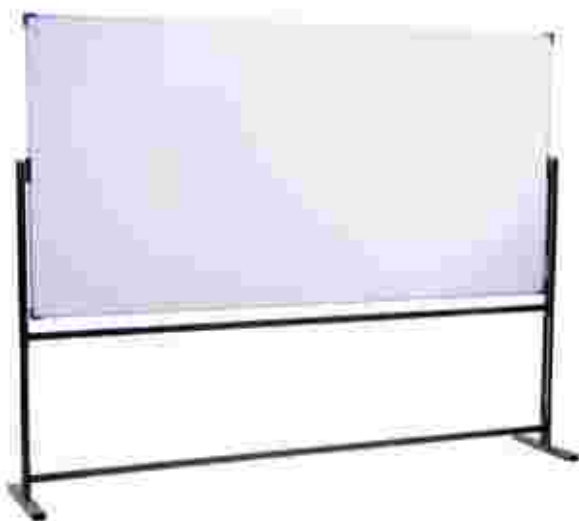

PRODUCT SPECIFICATIONS

Dimension W x H (mm) (Board Only)	2400 X 1200 (WS-1224) 1800 X 1200 (WS-1218)
Contain per Carton	1
Frame Finishing	Powder Coating
Frame Colour	Black
Panel Board Material	Particle Board + Melamine

PRODUCT DIMENSION

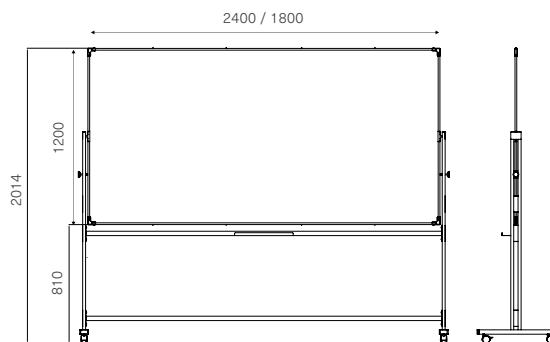

PRODUCT SPECIFICATIONS

Dimension W x D x H (mm)	511 X 582 X 795
Contain per Carton	4
Memo Table Material	Particle Board
Frame Colour	Silver
Frame Finishing	Powder Coating

SEAT - BACK MATERIAL & COLOURS

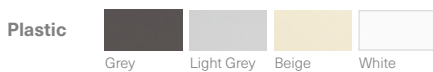

PRODUCT DIMENSION

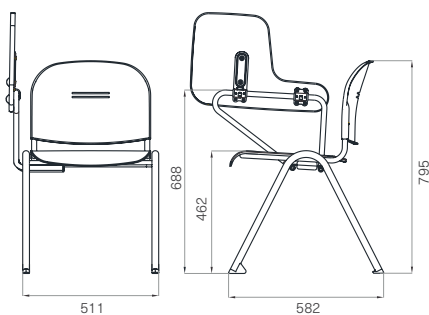

OLIVE A-LM



Large Memo



COLOUR BOX



Colour Box 89



Colour Box 35 S



Colour Box 35



Colour Box 35 D

PRODUCT SPECIFICATIONS

Dimension W x D x H (mm)	350 X 292 X 350 (35, 35S, 35D)
	420 X 290 X 890 (89)
Weight per Piece (kg)	3.6 / 4.4 / 4.4 / 8.8
Contain per Carton	1

PRODUCT DIMENSION

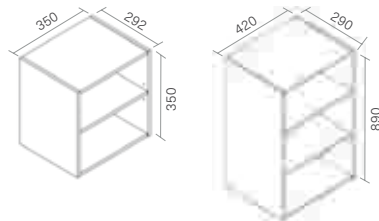

COLOUR OPTIONS & MATERIAL

Particle Board with Back Panel MDF

Colour Box 35, 35 S, 35 D

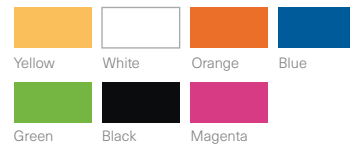

Colour Box 89



PRODUCT SPECIFICATIONS

Dimension W x D x H (mm)	1000 X 600 X 1200
Contain per Carton	1
Frame Colour	Light Grey
Frame Finishing	Powder Coating

COLOUR OPTIONS (DRAWER) & TABLE MATERIAL

Particle Board + PVC



PRODUCT DIMENSION

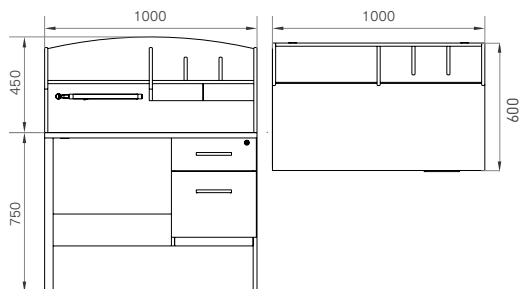

BENKYO HSD-01



DUO JUNIOR



PRODUCT SPECIFICATIONS

Dimension W x D x H (mm)	550 X 550 X 565-895
Weight per Piece (kg)	7
Contain per Carton	1
Frame Colour	Black

COLOUR OPTIONS & UPHOLSTERY MATERIAL

Fabric



S1 Blue

S2 Grey

S9 Pink

Black

BACK SEAT COLOUR

PRODUCT DIMENSION

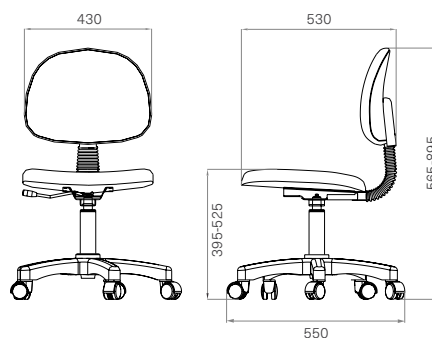

PRODUCT SPECIFICATIONS

Dimension W x D x H (mm)	570 X 370 X 750
Contain per Carton	1
Frame Finishing	Powder Coating

COLOUR OPTION & PANEL MATERIAL



Maple

PRODUCT DIMENSION

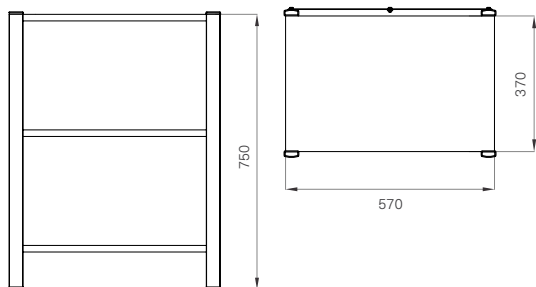

RACK JUNIOR







CELEBRATING MOMENT





Taro S
50



Hanako S
50



Jiro S
51



Caesar N/P
51



Prince
52



Sakata N
52



Callisto
53



Cavis
53



Olive A
54



Olive U
54



Sankei C-395
55



Glory
55



SAM
56



Flora H
56



Flora San
57



Ribbon P
57



TARO S



PRODUCT SPECIFICATIONS

Dimension W x D x H (mm)	455 X 463 X 890
Weight per Piece (kg)	6.5
Contain per Carton	4
Frame Finishing	Powder Coating
Frame Colour	Silver, Gold, Cream

COLOUR OPTIONS & UPHOLSTERY MATERIAL

Fabric				
	D1	D3	D6	D7
	A1 Blue	A3 Red	A4 Brown	A5 Cream

PRODUCT DIMENSION

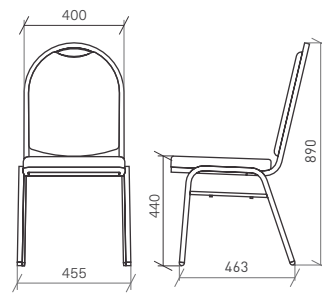

PRODUCT SPECIFICATIONS

Dimension W x D x H (mm)	455 X 463 X 890
Weight per Piece (kg)	6.8
Contain per Carton	4
Frame Finishing	Powder Coating
Frame Colour	Silver, Gold, Cream

COLOUR OPTIONS & UPHOLSTERY MATERIAL

Fabric				
	D1	D3	D6	D7
	A1 Blue	A3 Red	A4 Brown	A5 Cream

PRODUCT DIMENSION

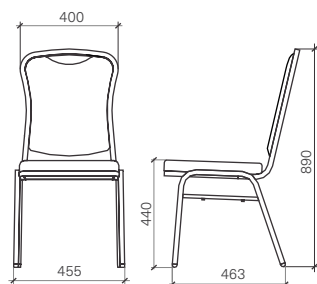

HANAKO S











JIRO S



PRODUCT SPECIFICATIONS

Dimension W x D x H (mm)	455 X 463 X 890
Weight per Piece (kg)	6.5
Contain per Carton	4
Frame Finishing	Powder Coating
Frame Colour	Silver, Gold, Cream

COLOUR OPTIONS & UPHOLSTERY MATERIAL

Fabric				
	D1	D3	D6	D7
				
	A1 Blue	A3 Red	A4 Brown	A5 Cream

PRODUCT DIMENSION

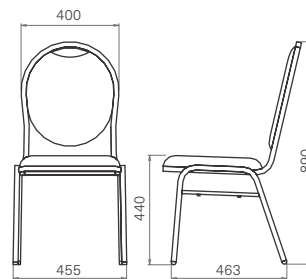

PRODUCT SPECIFICATIONS

Dimension W x D x H (mm)	420 X 505 X 868
Weight per Piece (kg)	5.3
Contain per Carton	4
Frame Finishing	Chrome Plating (N) Powder Coating (P)
Frame Colour	Black, Silver

COLOUR OPTIONS & UPHOLSTERY MATERIAL

Fabric							
	N3	N4	N5	L1	L2	L6	L7
PVC							
	V1	V3	V7				

PRODUCT DIMENSION

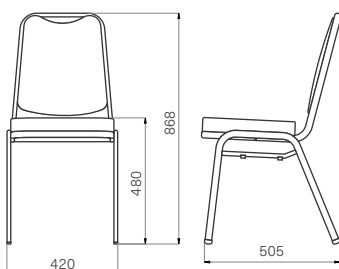

CAESAR N/P





PRINCE



PRODUCT SPECIFICATIONS

Dimension W x D x H (mm)	456 X 585 X 896
Weight per Piece (kg)	3.2
Contain per Carton	4
Frame Finishing	Chrome Plating Powder Coating
Frame Colour	Chrome, Gold, Silver

COLOUR OPTIONS & UPHOLSTERY MATERIAL



PRODUCT DIMENSION

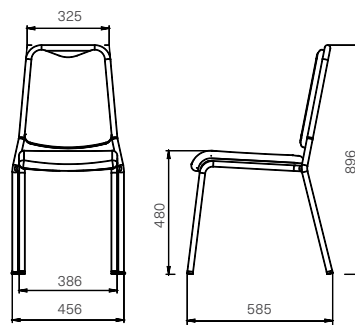

PRODUCT SPECIFICATIONS

Dimension W x D x H (mm)	435 X 512 X 895
Weight per Piece (kg)	4.8
Contain per Carton	4
Frame Finishing	Chrome Coating
Frame Colour	Chrome

COLOUR OPTIONS & UPHOLSTERY MATERIAL

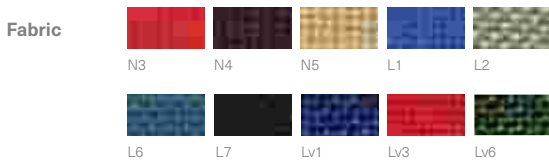

PRODUCT DIMENSION

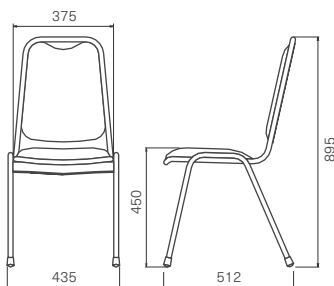

SAKATA N



CALLISTO



PRODUCT SPECIFICATIONS

Dimension W x D x H (mm)	460 X 527 X 900
Contain per Carton	2
Frame Finishing	Chrome Plating Powder Coating
Frame Colour	Grey

COLOUR OPTIONS & UPHOLSTERY MATERIAL

Fabric			
	N3 Red	L1 Blue	N4 Brown

PRODUCT DIMENSION

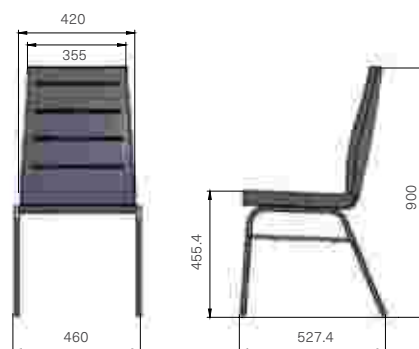

PRODUCT SPECIFICATIONS

Dimension W x D x H (mm)	476 X 507 X 780
Weight per Piece (kg)	5.3
Contain per Carton	4
Frame Finishing	Powder Coating
Frame Colour	Light, Grey, Ivory

COLOUR OPTIONS & UPHOLSTERY MATERIAL

Fabric							
	N3	N4	N5	L1	L2	L6	L7
PVC							
	V1	V3	V7				

PRODUCT DIMENSION

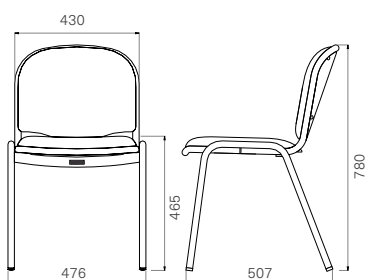

CAVIS





OLIVE A



PRODUCT SPECIFICATIONS

Dimension W x D x H (mm)	515 X 585 X 795
Weight per Piece (kg)	4.2
Contain per Carton	4
Frame Finishing	Powder Coating
Frame Colour	Silver

COLOUR OPTIONS & SEAT-BACK MATERIAL

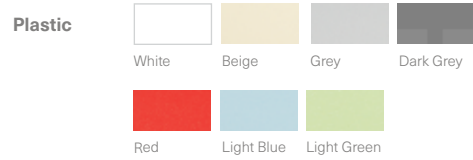

PRODUCT DIMENSION

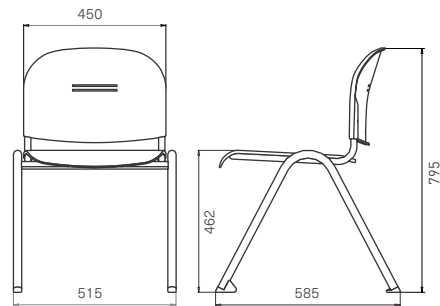

PRODUCT SPECIFICATIONS

Dimension W x D x H (mm)	480 X 555 X 806
Weight per Piece (kg)	4.1
Contain per Carton	4
Frame Finishing	Chrome Plating
Frame Colour	Chrome

COLOUR OPTIONS & SEAT-BACK MATERIAL

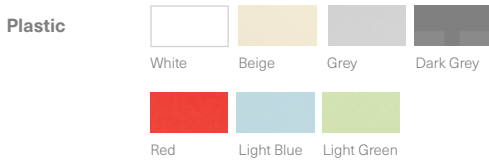

PRODUCT DIMENSION

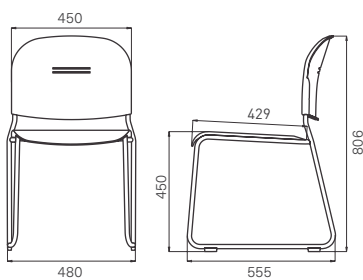

OLIVE U



SANKEI C-395



PRODUCT SPECIFICATIONS

Dimension W x D x H (mm)	478 X 510 X 775
Weight per Piece (kg)	3.4
Contain per Carton	4
Frame Finishing	Chrome Plating
Frame Colour	Chrome

COLOUR OPTIONS & SEAT-BACK MATERIAL



PRODUCT DIMENSION

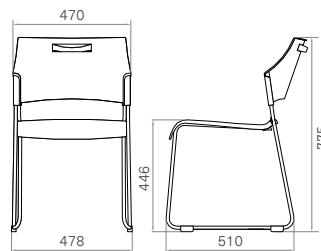

PRODUCT SPECIFICATIONS

Dimension W x D x H (mm)	437 X 436 X 807
Weight per Piece (kg)	3
Contain per Carton	4
Frame Finishing	Powder Coating
Frame Colour	White, Silver

COLOUR OPTIONS & SEAT-BACK MATERIAL



PRODUCT DIMENSION

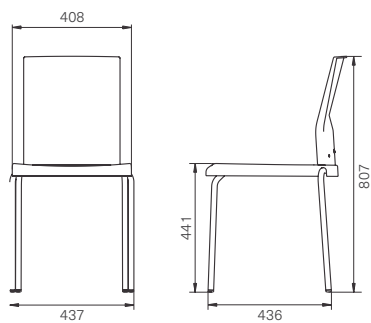

GLORY





SAM



PRODUCT SPECIFICATIONS

Dimension W x D x H (mm)	453 X 456 X 770
Weight per Piece (kg)	4.7
Contain per Carton	4
Frame Finishing	Powder Coating
Frame Colour	Grey, Silver, White, Orange

COLOUR OPTIONS & SEAT-BACK MATERIAL



PRODUCT DIMENSION

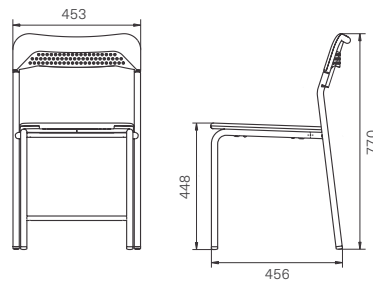

PRODUCT SPECIFICATIONS

Dimension W x D x H (mm)	495 X 415 X 675
Weight per Piece (kg)	3.8
Contain per Carton	4
Frame Finishing	Powder Coating
Frame Colour	Blue, Red, Green, Yellow, Pink, Cream, Light Blue, Light Green, Orange, Ivory

COLOUR OPTIONS & UPHOLSTERY MATERIAL

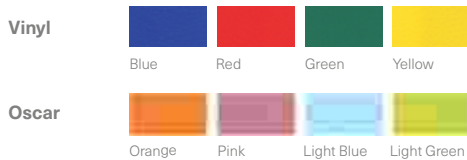

PRODUCT DIMENSION

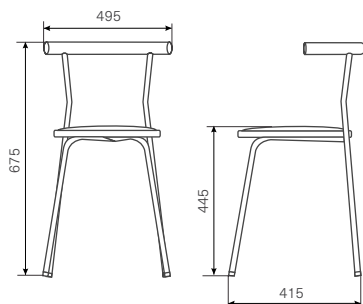

FLORA H



FLORA SAN



PRODUCT SPECIFICATIONS

Dimension W x D x H (mm)	515 X 515 X 445
Weight per Piece (kg)	2.5
Contain per Carton	6
Frame Finishing	Chrome Plating
Frame Colour	Chrome

COLOUR OPTIONS & UPHOLSTERY MATERIAL



PRODUCT DIMENSION

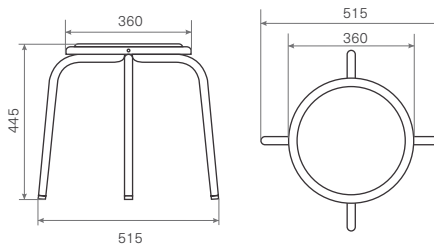

PRODUCT SPECIFICATIONS

Dimension W x D x H (mm)	435 X 435 X 462
Weight per Piece (kg)	1.6
Contain per Carton	6
Frame Finishing	Powder Coating
Frame Colour	Yellow, Black, Grey, Silver

COLOUR OPTIONS & SEAT MATERIAL



PRODUCT DIMENSION

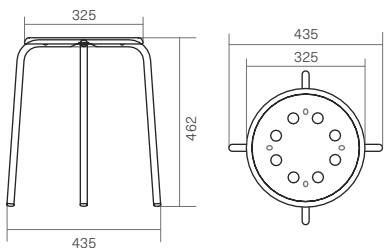

RIBBON P







Hobby Table T-1010
60



Table T-1010
60



Table T-7575
61



Coffee Table R-75
61



Coffee Table T-60
62



Coffee Table T-60 NE
62



Coffee Table T-60 PL
63



Table T-6012 Kotatsu
63



Coffee Table T-60 Kotatsu
64



FTC-6012
64



FTC-6018
65



FTC-6012 NE
65

HOBBY TABLE T-1010



PRODUCT SPECIFICATIONS

Dimension W x D x H (mm)	1000 X 1000 X 750
Table Top Material	Plate
Contain per Carton	1
Frame Finishing	Powder Coating
Frame Colour	Ivory

TABLE COLOUR OPTION



Cream (Hammerstone)

PRODUCT DIMENSION

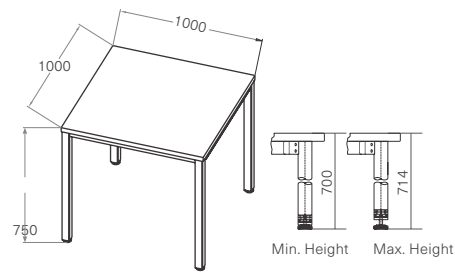

PRODUCT SPECIFICATIONS

Dimension W x D x H (mm)	1000 X 1000 X 700
Table Top Material	Particle Board Solid covered with PVC
Contain per Carton	1
Frame Finishing	Powder Coating
Frame Colour	Ivory, Light Grey

TABLE COLOUR OPTIONS



Light Grey Maple

PRODUCT DIMENSION

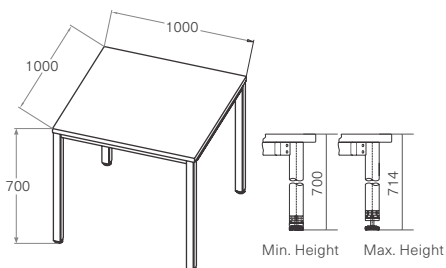

TABLE T-1010



TABLE T-7575



PRODUCT SPECIFICATIONS

Dimension W x D x H (mm)	750 X 750 X 700
Table Top Material	Particle Board Covered with PVC
Contain per Carton	1
Frame Finishing	Powder Coating
Frame Colour	Ivory, Light Grey

TABLE COLOUR OPTIONS



Light Grey Maple

PRODUCT DIMENSION

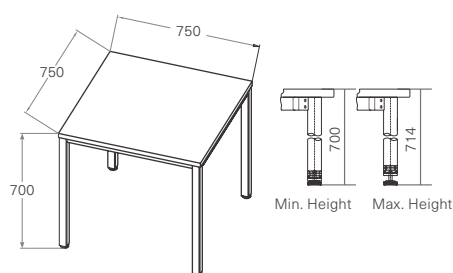

PRODUCT SPECIFICATIONS

Dimension W x D x H (mm)	750 X 750 X 700
Table Top Material	Particle Board Solid covered with PVC + MDF
Contain per Carton	1
Frame Colour	Grey, Black
Frame Finishing	Powder Coating

TABLE COLOUR OPTION



Maple

PRODUCT DIMENSION

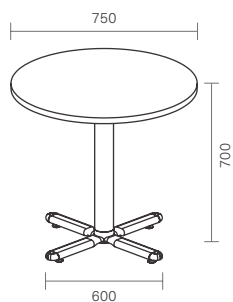

COFFEE TABLE R-75



COFFEE TABLE T-60



PRODUCT SPECIFICATIONS

Dimension W x D x H (mm)	600 X 600 X 700
Table Top Material	Particle Board covered with PVC + MDF
Contain per Carton	1
Frame Colour	Grey, Black
Frame Finishing	Powder Coating

TABLE COLOUR OPTION



Maple

PRODUCT DIMENSION

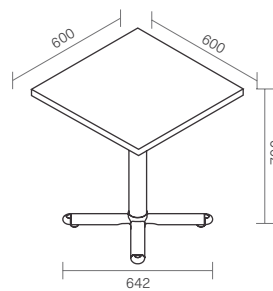

PRODUCT SPECIFICATIONS

Dimension W x D x H (mm)	600 X 600 X 700
Table Top Material	Particle Board Solid Laminated with HPL (Top), PVC (Bottom)
Frame Finishing	Powder Coating
Contain per Carton	1
Frame Colour	Grey, Black

TABLE COLOUR OPTION



White

PRODUCT DIMENSION

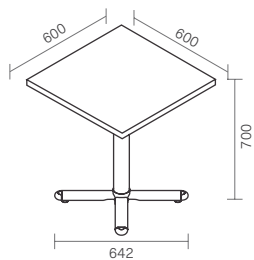

COFFEE TABLE T-60 NE



COFEE TABLE T-60 PL



PRODUCT SPECIFICATIONS

Dimension W x D x H (mm)	600 X 600 X 700
Table Top Material	Plate
Frame Finishing	Powder Coating
Contain per Carton	1
Frame Colour	Grey, Black

TABLE COLOUR OPTION



Cream (Hammertone)

PRODUCT DIMENSION

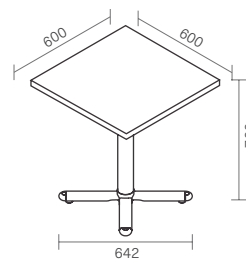

PRODUCT SPECIFICATIONS

Dimension W x D x H (mm)	1200 X 600 X 700
Table Top Material	MDF Honeycomb Paper + Particle Board
Contain per Carton	1
Frame Finishing	Powder Coating
Frame Colour	Black

TABLE COLOUR OPTION



Brown

PRODUCT DIMENSION

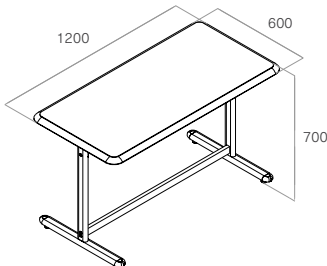

TABLE T-6012 KOTATSU





COFFEE TABLE T-60 KOTATSU



PRODUCT SPECIFICATIONS

Dimension W x D x H (mm)	600 X 600 X 700
Table Top Material	MDF Honeycomb Paper + Particle Board
Contain per Carton	1
Frame Finishing	Powder Coating
Frame Colour	Black

TABLE COLOUR OPTION



Brown

PRODUCT DIMENSION

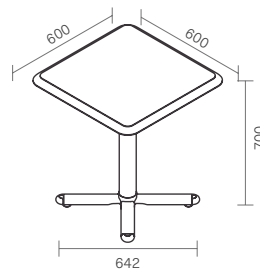

PRODUCT SPECIFICATIONS

Dimension W x D x H (mm)	1200 X 600 X 750
Table Top Material	Particle Board Solid
Contain per Carton	1
Frame Finishing	Powder Coating
Frame Colour	Grey Hammertone

FTC-6012

TABLE COLOUR OPTIONS



Light Grey Maple

PRODUCT DIMENSION

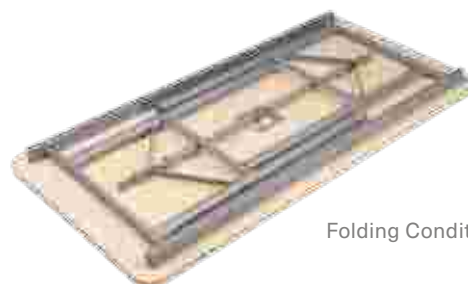
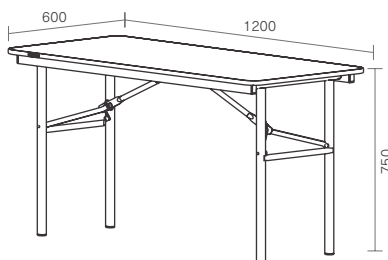

Folding Condition

FTC-6018

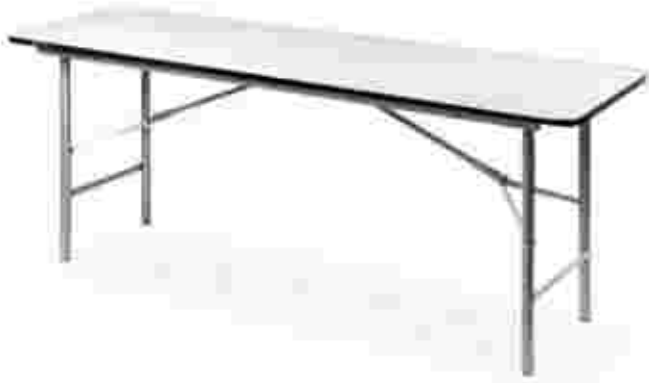

PRODUCT SPECIFICATIONS

Dimension W x D x H (mm)	1800 X 600 X 750
Table Top Material	Particle Board Solid Laminated with HPL
Contain per Carton	1
Frame Finishing	Powder Coating
Frame Colour	Grey Hammertone

TABLE COLOUR OPTIONS

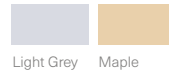

Light Grey Maple

PRODUCT DIMENSION

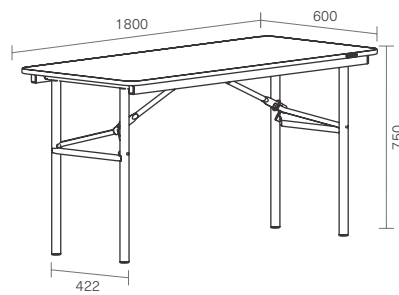

PRODUCT SPECIFICATIONS

Dimension W x D x H (mm)	1200 X 600 X 700
Table Top Material	Particle Board Solid Laminated with HPL (Top), PVC (Bottom)
Contain per Carton	1
Frame Finishing	Powder Coating
Frame Colour	Grey Hammertone

TABLE COLOUR OPTION



White

PRODUCT DIMENSION

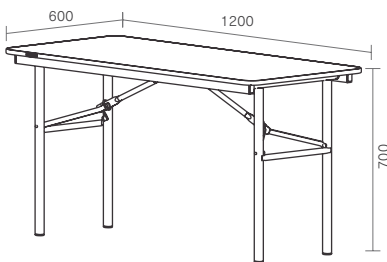

FTC-6012 NE







DELIGHTFUL FEELING



AJ Chair
70



CB Chair
71



Sylphy
72



Porus
72



Legno-203
73



Legno-201
73



Medix-611
74



Epo-530
74



Epo-330
75



Epo-130
76



ET-170
77



ET-171
77



Duo-01
78



Duo-02
78



ET D-500 / ET D-501
79



NBK
80



NA
80



NAN
80



NC
80



81T2
81



Fitto SW
81



Fitto FL
82



Fitto FL-A
82



Fitto FL-R
82



Sankei C-350 C
83



Sankei C-350
83







AJ CHAIR



PRODUCT SPECIFICATIONS

Dimension W x D x H (mm)	670 X 605 X 965-1065
Weight per Piece (kg)	17.2
Contain per Carton	1
Frame Colour	Black

COLOUR OPTIONS & UPHOLSTERY MATERIAL

Fabric				
	Red	Green	Blue	Grey
Plastic (back)				
	Black			

PRODUCT DIMENSION

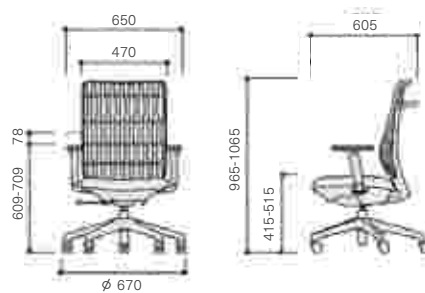

AJ Chair

CB CHAIR



Produced by Okamura-Japan



PRODUCT SPECIFICATIONS

Dimension W x D x H (mm)	630 X 640 X 890-986
Weight per Piece (kg)	16.5
Contain per Carton	1
Back Material Frame Colour	Mesh with "Wing Back Support"

COLOUR OPTIONS & UPHOLSTERY MATERIAL

Fabric				
	Black	Green	Blue	Orange

PRODUCT DIMENSION

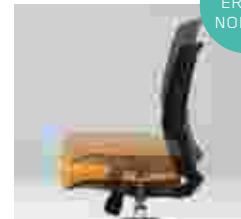
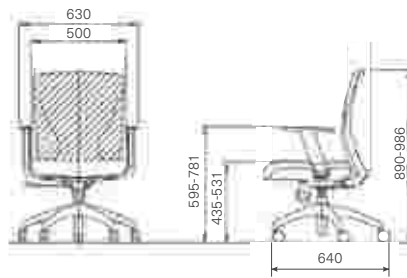



SYLPHY

Produced by Okamura-Japan



PRODUCT SPECIFICATIONS

Dimension W x D x H (mm)	648 X 717 X 960-1080
Weight per Piece (kg)	21.7
Contain per Carton	1

COLOUR OPTIONS & UPHOLSTERY MATERIAL

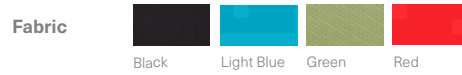

PRODUCT DIMENSION

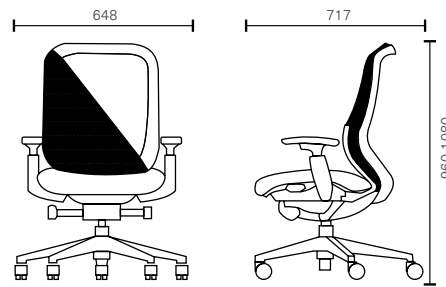

PRODUCT SPECIFICATIONS

Dimension W x D x H (mm)	646 X 576 X 982-1082
Contain per Carton	1

COLOUR OPTIONS & UPHOLSTERY MATERIAL

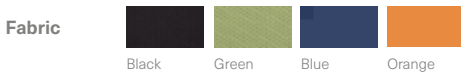

PRODUCT DIMENSION

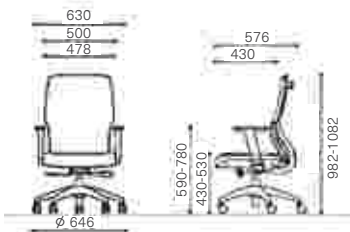

PORUS



LEGNO-203 (HIGH BACK)



PRODUCT SPECIFICATIONS

Dimension W x D x H (mm)	595 X 595 X 910-1000
Weight per Piece (kg)	15
Contain per Carton	1
Frame Colour	Grey

COLOUR OPTIONS & UPHOLSTERY MATERIAL

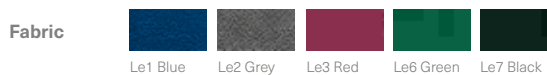

PRODUCT DIMENSION

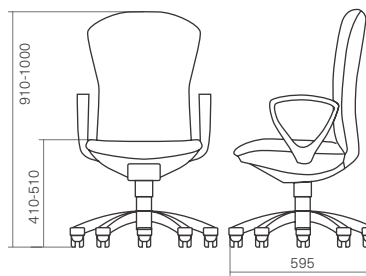

PRODUCT SPECIFICATIONS

Dimension W x D x H (mm)	595 X 595 X 840-930
Weight per Piece (kg)	14
Contain per Carton	1
Frame Colour	Grey

COLOUR OPTIONS & UPHOLSTERY MATERIAL

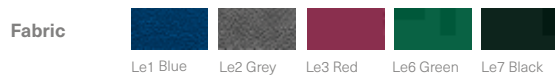

PRODUCT DIMENSION

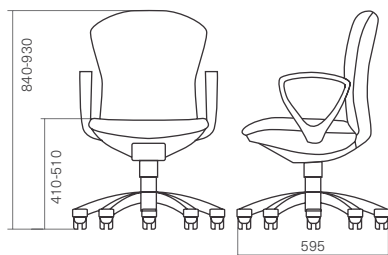

LEGNO-201 (LOW BACK)





MEDIX-611



PRODUCT SPECIFICATIONS

Dimension W x D x H (mm)	595 X 595 X 825-935
Weight per Piece (kg)	13
Contain per Carton	1
Frame Colour	Grey

COLOUR OPTIONS & UPHOLSTERY MATERIAL

Fabric				
	Md1 Blue	Md2 Grey	Md3 Pink	Md6 Green

PRODUCT DIMENSION

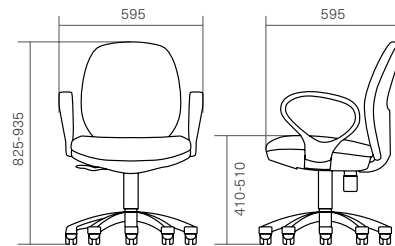

PRODUCT SPECIFICATIONS

Dimension W x D x H (mm)	600 X 567 X 930-1038
Weight per Piece (kg)	13
Contain per Carton	1
Frame Finishing	AL Anodizing + Plastic Shibo
Frame Colour	Black

COLOUR OPTIONS & UPHOLSTERY MATERIAL

Fabric					
	W1 Blue	W2 Grey	W3 Red	W6 Green	W7 Black

PRODUCT DIMENSION

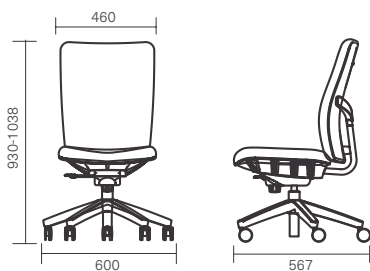

EPO-530



EPO-330



PRODUCT SPECIFICATIONS

Dimension W x D x H (mm)	600 X 567 X 816-916
Weight per Piece (kg)	14.5
Contain per Carton	1
Frame Finishing	AL Anodizing + Plastic Shibo
Frame Colour	Alumunium Black

COLOUR OPTIONS & UPHOLSTERY MATERIAL

Fabric					
	W1 Blue	W2 Grey	W3 Pink	W6 Green	W6 Black

PRODUCT DIMENSION

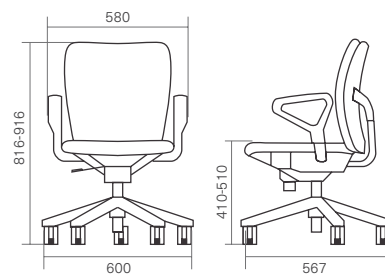

Epo-530





EPO-130



PRODUCT SPECIFICATIONS

Dimension W x D x H (mm)	600 X 567 X 760-860
Weight per Piece (kg)	13
Contain per Carton	1
Frame Finishing	AL Anodizing + Plastic Shibo
Frame Colour	Aluminium Black

COLOUR OPTIONS & UPHOLSTERY MATERIAL

Fabric					
	W1 Blue	W2 Grey	W3 Red	W6 Green	W7 Black

PRODUCT DIMENSION

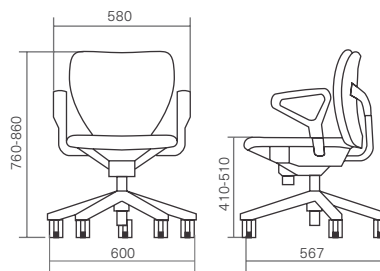

Epo-330







ET-170



PRODUCT SPECIFICATIONS

Dimension W x D x H (mm)	460 X 620 X 845-925
Weight per Piece (kg)	13.5
Contain per Carton	1
Frame Colour	Grey

COLOUR OPTIONS & UPHOLSTERY MATERIAL

Fabric			
	N3 Red	N4 Brown	N5 Cream
			
	L1 Blue	L2 Grey	L6 Green
			
			L7 Black



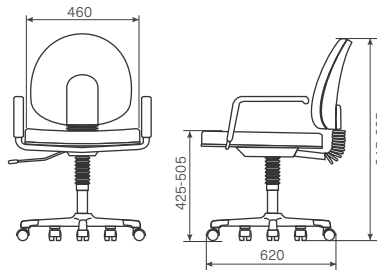



PRODUCT DIMENSION



PRODUCT SPECIFICATIONS

Dimension W x D x H (mm)	460 X 620 X 845-925
Weight per Piece (kg)	10.6
Contain per Carton	1
Frame Colour	Grey

COLOUR OPTIONS & UPHOLSTERY MATERIAL

Fabric			
	N3 Red	N4 Brown	N5 Cream
			
	L1 Blue	L2 Grey	L6 Green
			
			L7 Black

PRODUCT DIMENSION

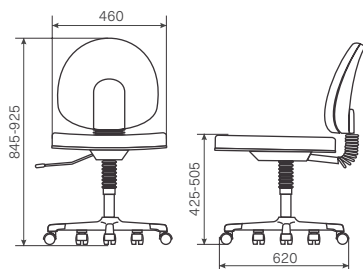

ET-171





DUO-01



PRODUCT SPECIFICATIONS

Dimension W x D x H (mm)	465 X 550 X 870-985
Weight per Piece (kg)	8.8
Contain per Carton	1
Frame Colour	Black

COLOUR OPTIONS & UPHOLSTERY MATERIAL

Fabric



Sd3 Red Sd8 Yellow Sd6 Green



Sd1 Blue Sd7 Black

BACK COLOUR



Sd7 Black

PRODUCT DIMENSION

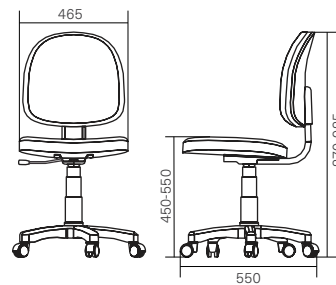

PRODUCT SPECIFICATIONS

Dimension W x D x H (mm)	424 X 550 X 870-950
Weight per Piece (kg)	7.3
Contain per Carton	1
Frame Colour	Black

COLOUR OPTIONS & UPHOLSTERY MATERIAL

Fabric



Sd3 Red Sd8 Yellow Sd6 Green



Sd1 Blue Sd7 Black

BACK COLOUR



Sd7 Black

PRODUCT DIMENSION

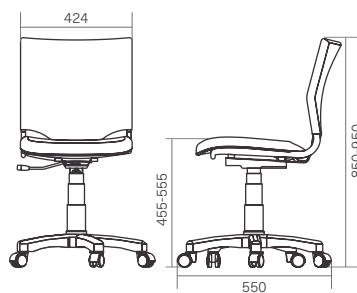

DUO 02



ET D-500 / ET D-501



ET D-500







ET D-501

PRODUCT SPECIFICATIONS

Dimension W x D x H (mm)	452 X 550 X 840-950
Weight per Piece (kg)	10.5 (ET D-500), 9.3 (ET D-501)
Contain per Carton	1
Frame Colour	Black

COLOUR OPTIONS & UPHOLSTERY MATERIAL

Oscar		
	07 Black	T14 Navy Blue
Fabric		
	L1 Blue	L7 Black

PRODUCT DIMENSION

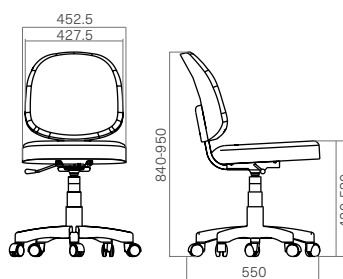

ET D-500





NBK / NA

PRODUCT SPECIFICATIONS

Dimension W x D x H (mm)	395 X 510 X 770-860
Weight per Piece (kg)	9.1 (NBK), 6.5 (NA)
Contain per Carton	2
Frame Finishing	Hammertone, Powder Coating



NBK



NA

COLOUR OPTIONS & UPHOLSTERY MATERIAL

PVC



V7 Black Vinyl

PRODUCT DIMENSION

NBK

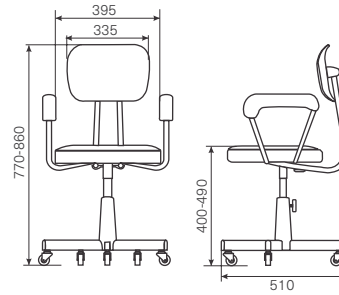

NA

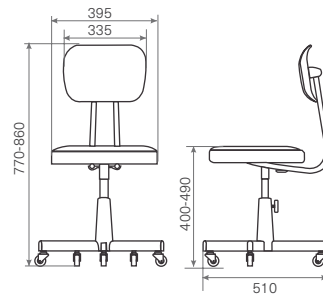

NAN / NC

PRODUCT SPECIFICATIONS

Dimension W x D x H (mm)	395 X 510 X 710-800 (NAN) 395 X 510 X 920-1010 (NC)
Contain per Carton	2
Weight per Piece (kg)	6.5 (NAN), 8.2 (NC)
Frame Finishing	Hammertone, Powder Coating



NAN



NC

COLOUR OPTIONS & UPHOLSTERY MATERIAL

PVC



V7 Black Vinyl

PRODUCT DIMENSION

NAN

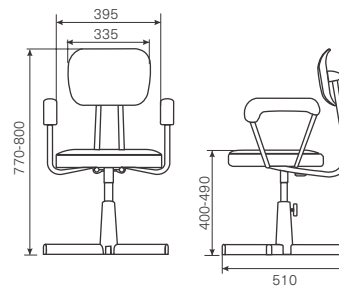

NC

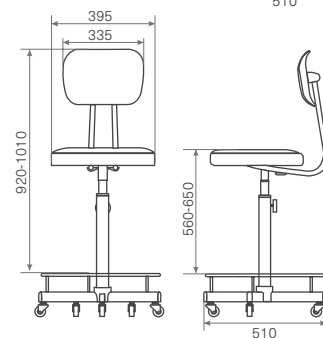

81T2



Nesting



Stacking
(up to 4 chairs)







Produced by Okamura-Japan



PRODUCT SPECIFICATIONS

Dimension W x D x H (mm)	560 X 504 X 783
Weight per Piece (kg)	7.5
Contain per Carton	2
Back Material	Plastic

COLOUR OPTIONS & UPHOLSTERY MATERIAL

Fabric				
	Black	Light Green	Light Blue	Orange

PRODUCT DIMENSION

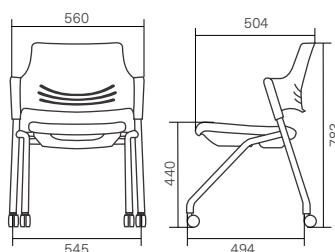

PRODUCT SPECIFICATIONS

Dimension W x D x H (mm)	588 X 550 X 802-902
Weight per Piece (kg)	6.8
Contain per Carton	1
Frame Finishing	Powder Coating
Frame Colour	Silver
Back Material	Plastic PP (Grey)

COLOUR OPTIONS & UPHOLSTERY MATERIAL

Fabric				
	Red	Orange	Green	Blue

PRODUCT DIMENSION

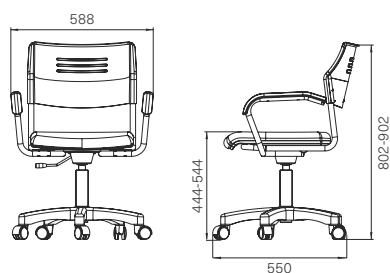

FITTO SW





FITTO FL



PRODUCT SPECIFICATIONS

Dimension W x D x H (mm)	557 X 571 X 850
Weight per Piece (kg)	5.9
Contain per Carton	4
Frame Finishing	Powder Coating
Frame Colour	Silver
Back Material	Plastic PP (Grey)

COLOUR OPTIONS & UPHOLSTERY MATERIAL



PRODUCT DIMENSION

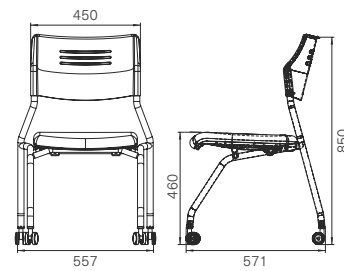

PRODUCT SPECIFICATIONS

Dimension W x D x H (mm)	589 X 554 X 850 (Fitto FL-A) 557 X 571 X 850 (Fitto FL-R)
Weight per Piece (kg)	5.9
Contain per Carton	4
Frame Finishing	Powder Coating
Frame Colour	Silver
Back Material	Plastic PP (Grey)

COLOUR OPTIONS & UPHOLSTERY MATERIAL



PRODUCT DIMENSION

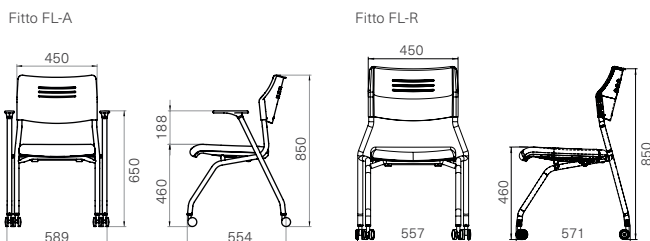

FITTO FL-A / FITTO FL-R



Fitto FL-A



Fitto FL-R



Fitto FL-R



Fitto FL-A

SANKEI C-350 C (WITH CASTER)



PRODUCT SPECIFICATIONS

Dimension W x D x H (mm)	565 X 500 X 760
Weight per Piece (kg)	6.1
Contain per Carton	2
Frame Finishing	Powder Coating
Frame Colour	Grey

COLOUR OPTIONS & UPHOLSTERY MATERIAL

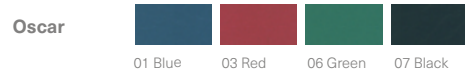

PRODUCT DIMENSION

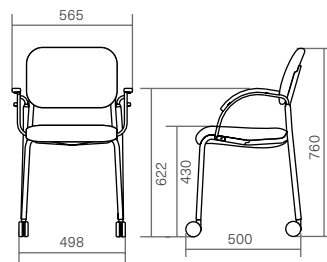

PRODUCT SPECIFICATIONS

Dimension W x D x H (mm)	565 X 500 X 760
Weight per Piece (kg)	5.1
Contain per Carton	2
Frame Finishing	Powder Coating
Frame Colour	Grey

COLOUR OPTIONS & UPHOLSTERY MATERIAL



PRODUCT DIMENSION

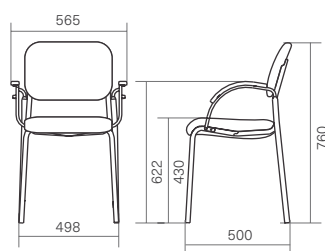

SANKEI C-350 (STANDARD)







Olive SC
86



Olive DX
87



Fronty
88



Duo-03
88



Duo-04
89



Jasmine C-211
90



Jasmine C-111
91



Cozy
91



Yuki
92



Lotus
92



Fitto ST
93



Sankei C-371
93



Kasai
94



Leon
94



Vista N/P
95



Costa
95



OLIVE SC



PRODUCT SPECIFICATIONS

Dimension W x D x H (mm)	495 X 559 X 805
Weight per Piece (kg)	4.3
Contain per Carton	4
Frame Finishing	Powder Coating, Chrome Plating
Frame Colour	Chrome, White, Ivory
Back Material	Plastic (White, Dark Grey, Beige)

COLOUR OPTIONS & UPHOLSTERY MATERIAL

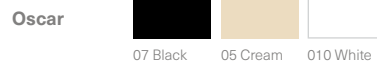

PRODUCT DIMENSION

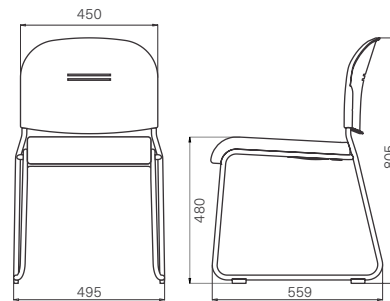

OLive SC



OLIVE DX



PRODUCT SPECIFICATIONS

Dimension W x D x H (mm)	495 X 559 X 868
Weight per Piece (kg)	5.9
Contain per Carton	2
Frame Finishing	Chrome Plating
Frame Colour	Chrome

COLOUR OPTIONS & UPHOLSTERY MATERIAL

Oscar



Se7 Black T4 Brown

PRODUCT DIMENSION

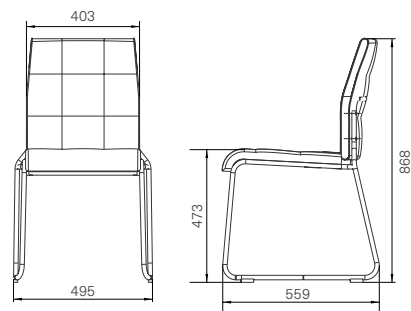

Olive DX



FRONTY



PRODUCT SPECIFICATIONS

Dimension W x D x H (mm)	538 X 620 X 855
Weight per Piece (kg)	8.6
Contain per Carton	2
Frame Finishing	Powder Coating
Frame Colour	Black, Silver

COLOUR OPTIONS & UPHOLSTERY MATERIAL

Oscar 
Se7 Black

PRODUCT DIMENSION

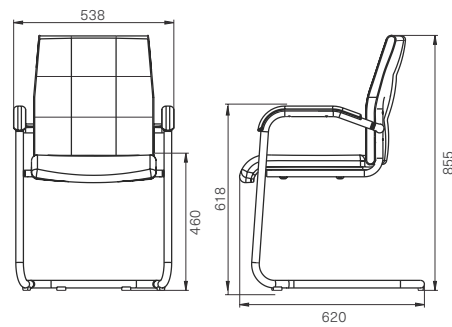

PRODUCT SPECIFICATIONS

Dimension W x D x H (mm)	437 X 577 X 867
Weight per Piece (kg)	6.5
Contain per Carton	2
Frame Finishing	Powder Coating
Frame Colour	Black

DUO-03

COLOUR OPTIONS & UPHOLSTERY MATERIAL

Fabric

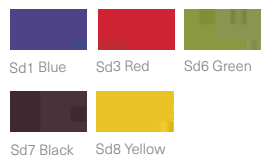

BACK & SEAT COLOUR



PRODUCT DIMENSION

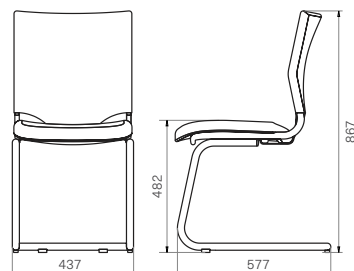

DUO-04



PRODUCT SPECIFICATIONS

Dimension W x D x H (mm)	490 X 468 X 850
Weight per Piece (kg)	6.5
Contain per Carton	4
Frame Finishing	Powder Coating
Frame Colour	Black

COLOUR OPTIONS & UPHOLSTERY MATERIAL

Fabric

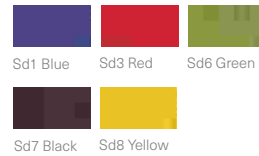

BACK & SEAT COLOUR



PRODUCT DIMENSION

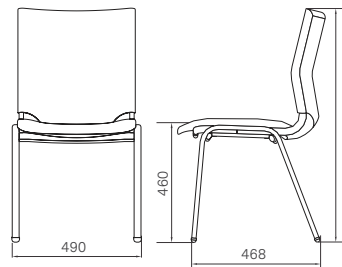



JASMINE C-211



PRODUCT SPECIFICATIONS

Dimension W x D x H (mm)	445 X 465 X 722
Weight per Piece (kg)	3.8
Contain per Carton	4
Frame Finishing	Chrome Plating
Frame Colour	Chrome
Back Material	Plastic (White, Grey)

COLOUR OPTIONS & UPHOLSTERY MATERIAL

Fabric				
	L12 Orange	L8 Yellow	L13 Green	
PVC Vinyl				
	V1 Blue	V3 Red	V7 Black	
Oscar				
	O1 Blue	O3 Red	O6 Green	O7 Green

PRODUCT DIMENSION

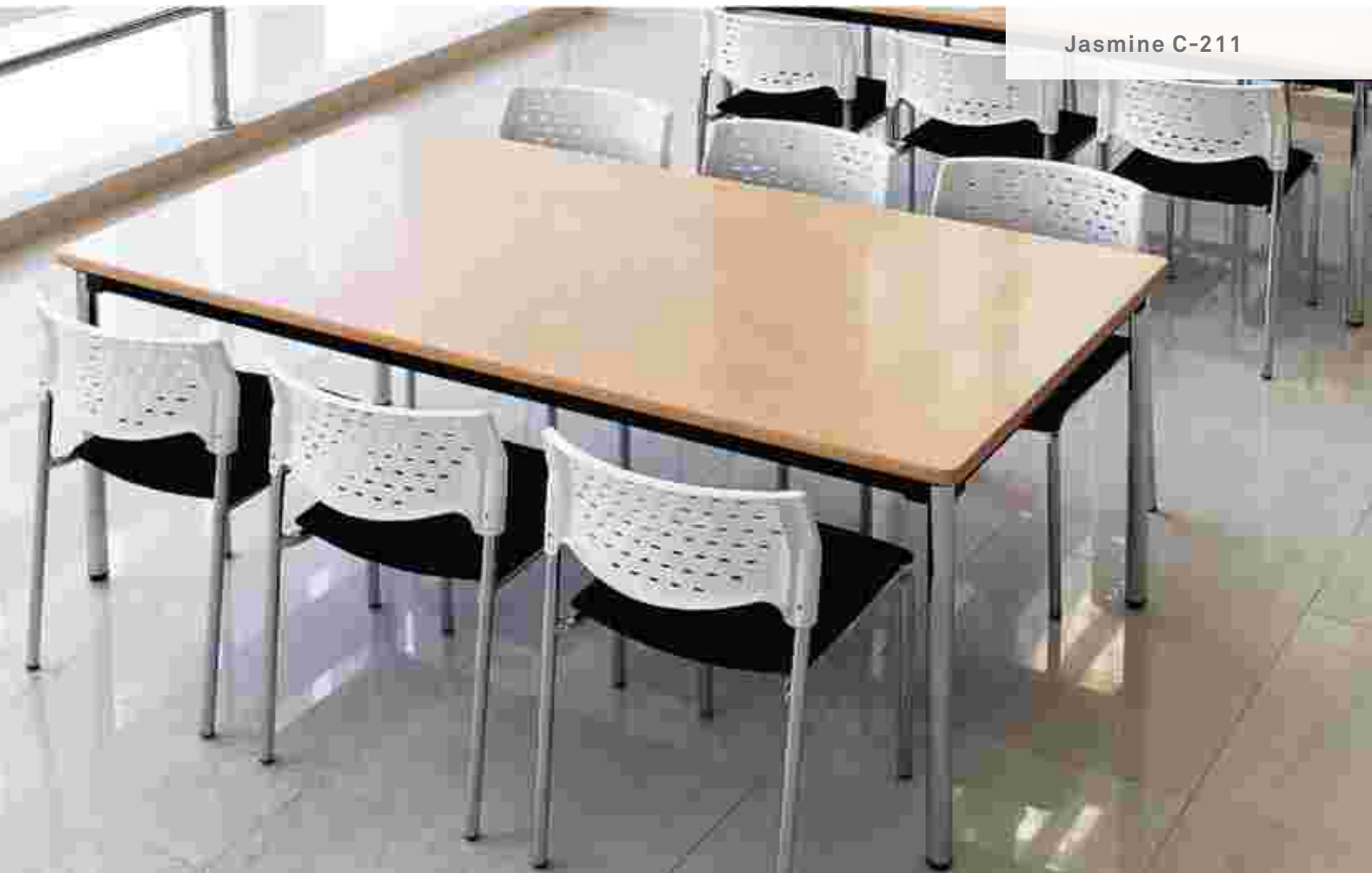
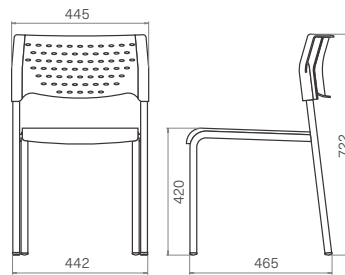

Jasmine C-211

JASMINE C-111



PRODUCT SPECIFICATIONS

Dimension W x D x H (mm)	465 X 478 X 747
Weight per Piece (kg)	3.7
Contain per Carton	4
Frame Finishing	Chrome Plating
Frame Colour	Chrome
Back Material	Plastic (White, Grey)

COLOUR OPTIONS & UPHOLSTERY MATERIAL

Fabric				
	L12 Orange	L8 Yellow	L13 Green	
PVC Vinyl				
	V1 Blue	V3 Red	V7 Black	
Oscar				
	01 Blue	03 Red	06 Green	07 Green

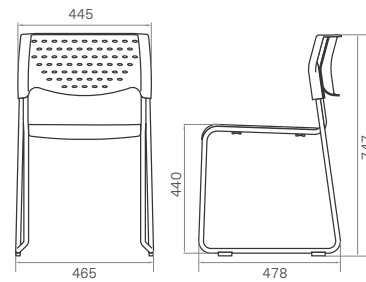

PRODUCT DIMENSION



PRODUCT SPECIFICATIONS

Dimension W x D x H (mm)	470 X 508 X 778
Weight per Piece (kg)	4.3
Contain per Carton	4
Frame Finishing	Chrome Plating
Frame Colour	Chrome

COLOUR OPTIONS & UPHOLSTERY MATERIAL

Fabric				
	S1 Blue	S2 Grey	S6 Green	S9 Pink
				
	Y1 Blue	Y2 Grey	Yk3 Maroon	

PRODUCT DIMENSION

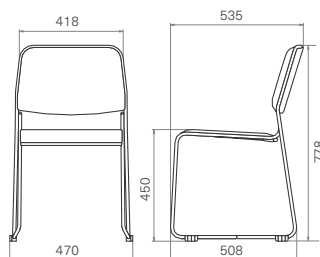

COZY





YUKI



PRODUCT SPECIFICATIONS

Dimension W x D x H (mm)	488 X 563 X 750
Weight per Piece (kg)	4.1
Contain per Carton	4
Frame Finishing	Powder Coating
Frame Colour	Silver

COLOUR OPTIONS & UPHOLSTERY MATERIAL

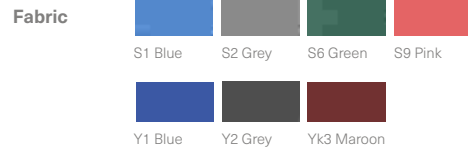

PRODUCT DIMENSION

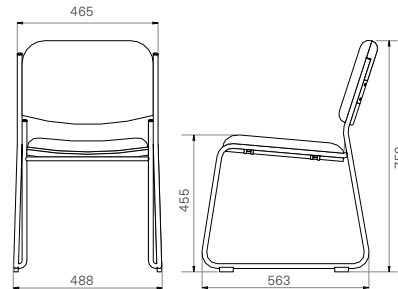

PRODUCT SPECIFICATIONS

Dimension W x D x H (mm)	500 X 510 X 760
Weight per Piece (kg)	3.5
Contain per Carton	4
Frame Finishing	Chrome Plating
Frame Colour	Chrome
Back Material	Plastic (Cream, Grey)

COLOUR OPTIONS & UPHOLSTERY MATERIAL

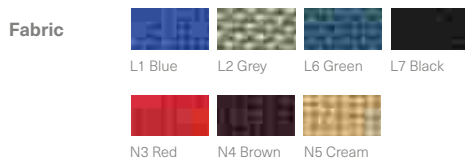

PRODUCT DIMENSION

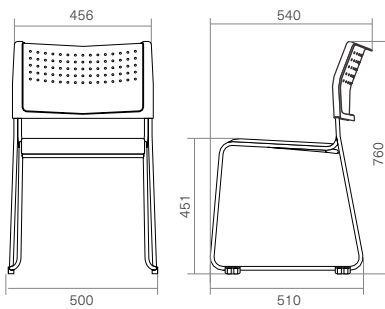

LOTUS



FITTO ST



PRODUCT SPECIFICATIONS

Dimension W x D x H (mm)	575 X 520 X 835
Weight per Piece (kg)	6.5
Contain per Carton	4
Frame Finishing	Powder Coating
Frame Colour	Silver
Back Material	Plastic PP (Grey)

COLOUR OPTIONS & UPHOLSTERY MATERIAL



PRODUCT DIMENSION

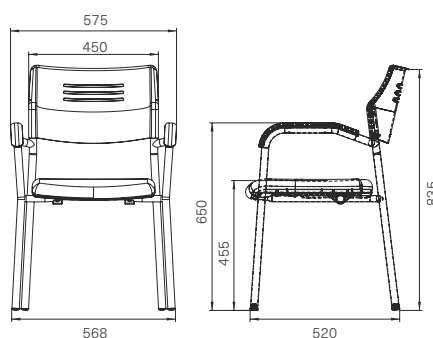

PRODUCT SPECIFICATIONS

Dimension W x D x H (mm)	493 X 510 X 783
Weight per Piece (kg)	3.7
Contain per Carton	4
Frame Finishing	Powder Coating
Frame Colour	Silver

COLOUR OPTIONS & UPHOLSTERY MATERIAL

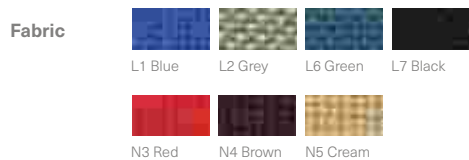

PRODUCT DIMENSION

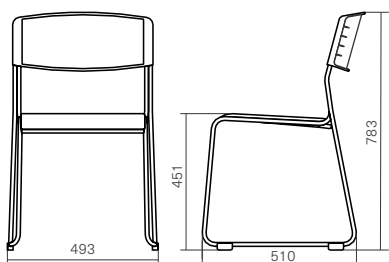

SANKEI C-371





KASAI



PRODUCT SPECIFICATIONS

Dimension W x D x H (mm)	470 X 480 X 755
Weight per Piece (kg)	3.9
Contain per Carton	4
Frame Finishing	Powder Coating
Frame Colour	Silver

COLOUR OPTIONS & UPHOLSTERY MATERIAL

Fabric				
	L1 Blue	L2 Grey	L6 Green	L7 Black
	N3 Red	N4 Brown	V5 Cream	
Oscar				
	O1 Blue	O3 Red	O6 Green	O7 Green

PRODUCT DIMENSION

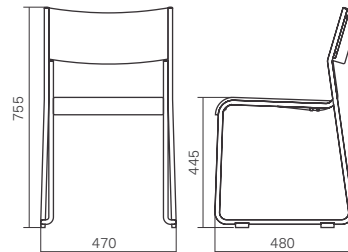

PRODUCT SPECIFICATIONS

Dimension W x D x H (mm)	471 X 610 X 772
Weight per Piece (kg)	5
Contain per Carton	4
Frame Finishing	Chrome Plating Powder Coating
Frame Colour	Chrome, Silver

COLOUR OPTIONS & UPHOLSTERY MATERIAL

Fabric				
	L1 Blue	L2 Grey	L6 Green	L7 Black
	N3 Red	N4 Brown	V5 Cream	
	O1 Blue	O3 Red	O6 Green	O7 Green

PRODUCT DIMENSION

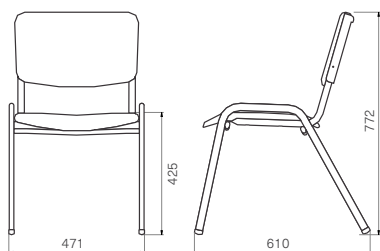

LEON









VISTA N/P



PRODUCT SPECIFICATIONS

Dimension W x D x H (mm)	435 X 560 X 785
Weight per Piece (kg)	6.7
Contain per Carton	2
Frame Finishing	Powder Coating (P) Chrome Plating (N)
Frame Colour	Black, Chrome

COLOUR OPTIONS & UPHOLSTERY MATERIAL

Fabric				
	L1 Blue	L2 Grey	L6 Green	L7 Black
				
	N3 Red	N4 Brown	V5 Cream	



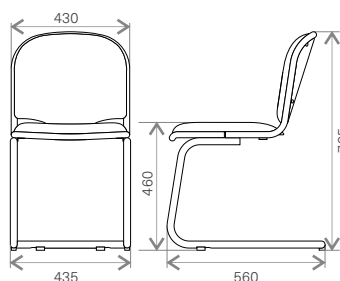

PRODUCT DIMENSION



PRODUCT SPECIFICATIONS

Dimension W x D x H (mm)	632 X 677 X 931
Contain per Carton	2
Frame Finishing	Chrome Plating
Frame Colour	Chrome

COLOUR OPTIONS & UPHOLSTERY MATERIAL

Oscar				
	Red	Blue	Brown	Grey

PRODUCT DIMENSION

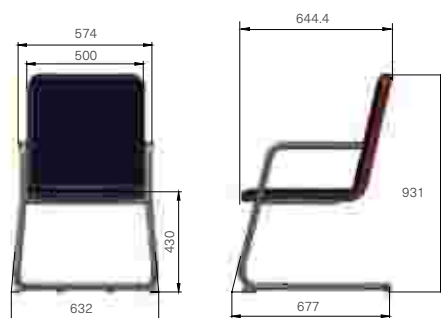

COSTA





TKM-7012 W / TKM-7014
98

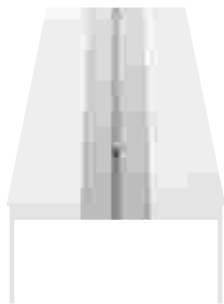

Manifold
99



SW
100



Flaptor
101

**Wagon WKM-6040**

102

**TU-7014**

102

**TU-6012**

103

**TU-7575 P**

103

**T-7014 L/R**

104

**T-7014**

104

**T-7012**

105

**Wagon W-6040**

105

**HTU-6014**

106

**FTU-6018**

106

**Kumi MT**

107

**Kumi ED**

107

**Kumi MD**

108

**Kumi SD**

108

**Kumi FD**

109

**Kumi Wagon 2D**

109

**Kumi Wagon 3D**

109

TKM-7012 W / TKM-7014

PRODUCT SPECIFICATIONS

Dimension W x D x H (mm)	1400 X 700 X 700 (TKM-7014) 1200 X 700 X 700 (TKM-7012 W)
Table Top Material	Particle Board + Melamine Laminated
Leg & Modelsty Panel	Steel with Powder Coating

TABLE COLOUR OPTION



PRODUCT DIMENSION

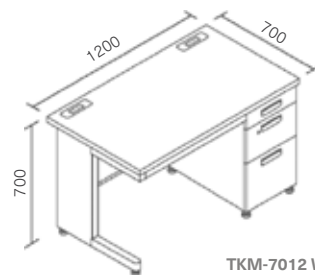
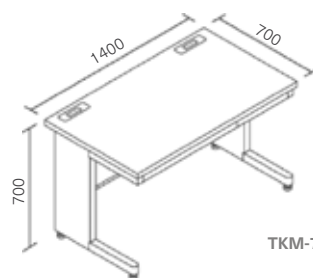

MANIFOLD WS-1200 & 2400, MT-1200 & 2400

PRODUCT SPECIFICATIONS

Dimension W x D x H (mm)	1200 X 1400 X 750 (WS-1200)
	2400 X 1400 X 750 (WS-2400)
	1200 X 1200 X 750 (MT-1200)
	2400 X 1200 X 750 (MT-2400)
Frame Colour	Neo White
Frame Finishing	Powder Coating

PRODUCT DIMENSION

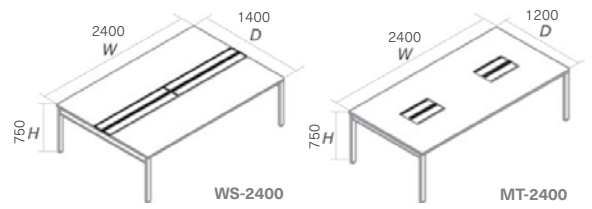
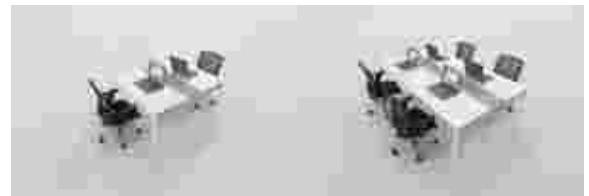
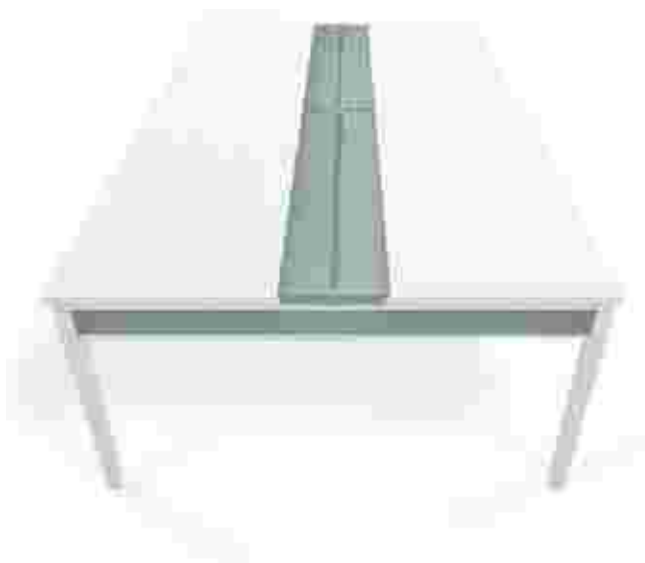

TABLE COLOUR OPTION



WS-1200 Work Station

WS-2400 Work Station



MT-1200 Meeting Table

MT-2400 Meeting Table





SW

Produced by Okamura-Japan



PRODUCT SPECIFICATIONS

Dimension W x D x H (mm)	1600 X 800 X 700-1250
Contain per Carton	1
Table Top Colour	White



Flip cover and cable snake for meeting table



Cable snake for work station

Height Indicator



Height Adjustable Table



Switching between sitting and standing

FLAPTOR

Produced by Okamura-Japan
Okamura

PRODUCT SPECIFICATIONS

Dimension W x D x H (mm)	1500 X 600 X 720
Weight per Piece (kg)	28.6
Contain per Carton	1
Table Top Material	Particle Board + Melamine Laminated

PRODUCT DIMENSION

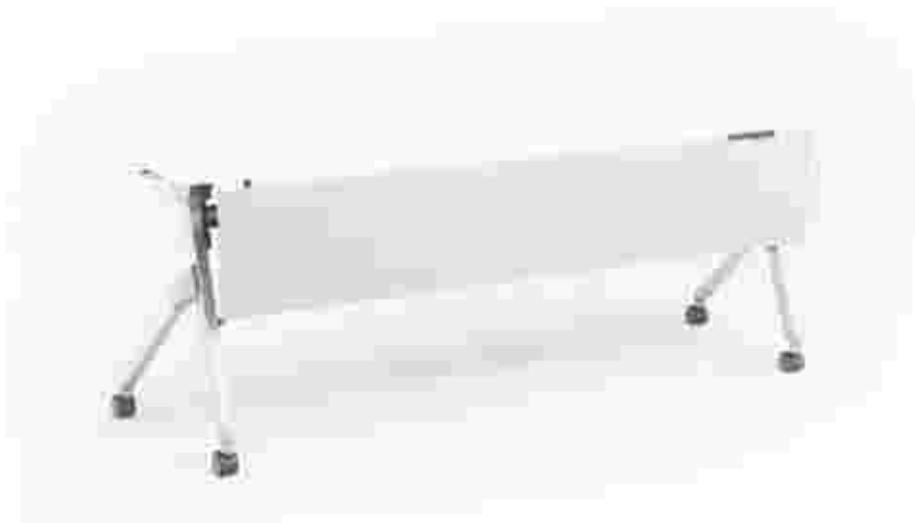
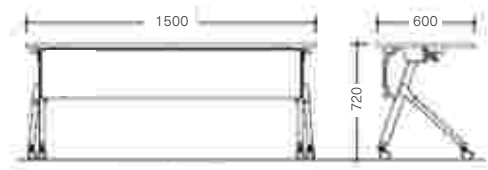

Folding Table



Flaptor

WAGON WKM-6040



PRODUCT SPECIFICATIONS

Dimension W x D x H (mm)	400 X 600 X 610
Contain per Carton	1
Top Board	ABS Plastic
Body Frame	Steel with Powder Coating

TABLE COLOUR OPTION

Steel with PC  Light Grey

PRODUCT DIMENSION

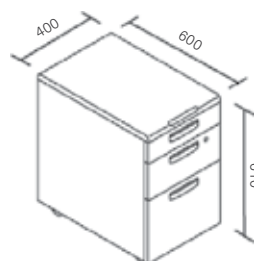

PRODUCT SPECIFICATIONS

Dimension W x D x H (mm)	1400 X 700 X 735-750
Weight per Piece (kg)	20.3
Contain per Carton	1
Table Top Material	Particle Board + MDF covered with PVC
Frame Colour	Black, Grey
Frame Finishing	Powder Coating

TU-7014

TABLE COLOUR OPTION

Particle Board + MDF covered with PVC  Dark Brown

PRODUCT DIMENSION

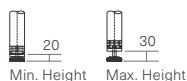
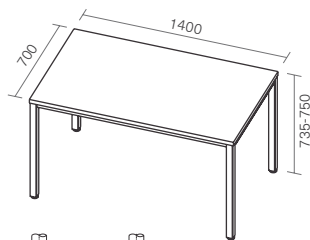

TU-6012



PRODUCT SPECIFICATIONS

Dimension W x D x H (mm)	1200 X 600 X 735-750
Weight per Piece (kg)	18
Contain per Carton	1
Table Top Material	Particle Board + MDF covered with PVC
Frame Colour	Black, Grey
Frame Finishing	Powder Coating

TABLE COLOUR OPTION

Particle Board + MDF covered with PVC



PRODUCT DIMENSION

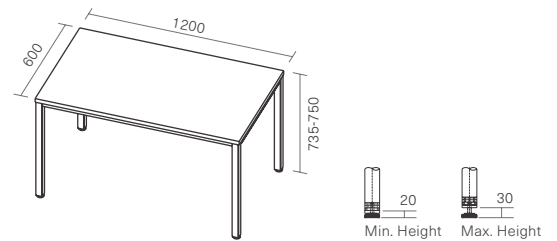

PRODUCT SPECIFICATIONS

Dimension W x D x H (mm)	750 X 750 X 700-715
Weight per Piece (kg)	14.4
Contain per Carton	1
Table Top Material	Particle Board + MDF covered with PVC
Frame Colour	Black
Frame Finishing	Powder Coating

TABLE COLOUR OPTION

Particle Board + MDF covered with PVC



PRODUCT DIMENSION

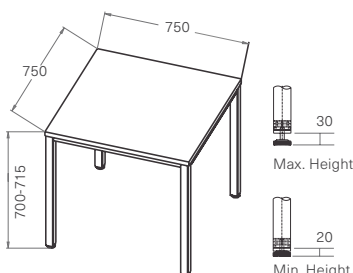

TU-7575 P



T-7014 L / T-7014 R



T-7014 L



T-7014 R

PRODUCT SPECIFICATIONS

Dimension W x D x H (mm)	1400 X 800 X 700
Weight per Piece (kg)	27
Contain per Carton	1
Table Top Material	Particle Board covered with PVC
Frame Colour	Silver
Frame Finishing	Powder Coating

TABLE COLOUR OPTIONS

Particle Board covered with PVC



Grey Maple

PRODUCT DIMENSION

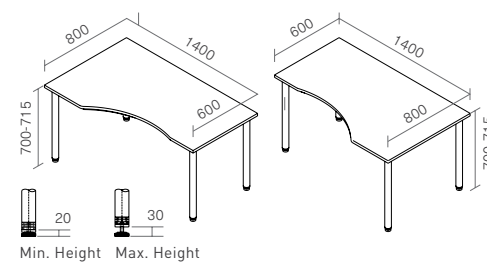

PRODUCT SPECIFICATIONS

Dimension W x D x H (mm)	1400 X 700 X 700
Weight per Piece (kg)	24
Contain per Carton	1
Table Top Material	Particle Board covered with PVC
Frame Colour	Silver
Frame Finishing	Powder Coating

T-7014

TABLE COLOUR OPTIONS

Particle Board covered with PVC



Grey Maple

PRODUCT DIMENSION

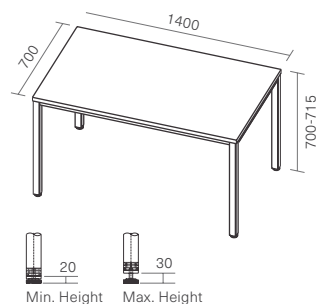

T-7012



PRODUCT SPECIFICATIONS

Dimension W x D x H (mm)	1200 X 700 X 700
Weight per Piece (kg)	18.5
Contain per Carton	1
Table Top Material	Particle Board covered with PVC
Frame Colour	Silver
Frame Finishing	Powder Coating

TABLE COLOUR OPTIONS

Particle Board covered with PVC



PRODUCT DIMENSION

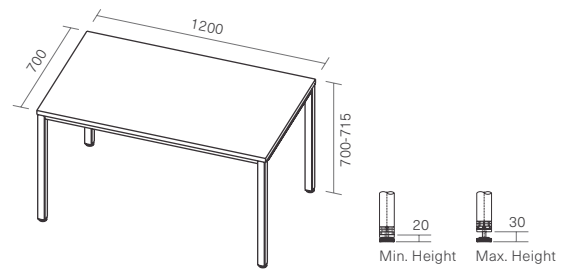

PRODUCT SPECIFICATIONS

Dimension W x D x H (mm)	420 X 500 X 600
Weight per Piece (kg)	25.3
Contain per Carton	1

TABLE COLOUR OPTIONS

Particle Board covered with PVC



PRODUCT DIMENSION

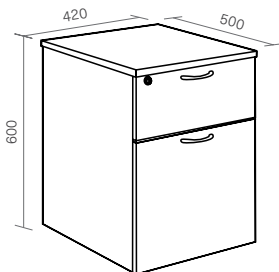

WAGON W-6040



HTU-6014



HTU-6014

PRODUCT SPECIFICATIONS

Dimension W x D x H (mm)	1400 X 600 X 735-750
Contain per Carton	1
Table Top Material	Particle Board + MDF covered with PVC
Frame Colour	Silver
Frame Finishing	Powder Coating

TABLE COLOUR OPTIONS

Particle Board + MDF covered with PVC		
	Grey	Maple

PRODUCT DIMENSION

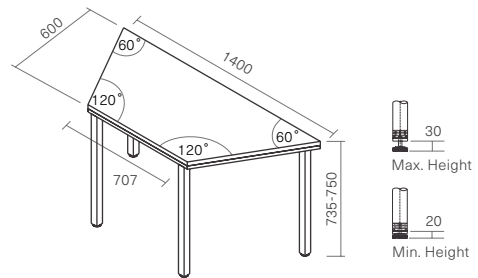

PRODUCT SPECIFICATIONS

Dimension W x D x H (mm)	1800 X 600 X 750
Weight per Piece (kg)	36
Contain per Carton	1
Frame Colour	Grey
Frame Finishing	Powder Coating

FTU-6018

TABLE COLOUR OPTIONS

Particle Board + MDF covered with PVC		
	Grey	Maple

PRODUCT DIMENSION

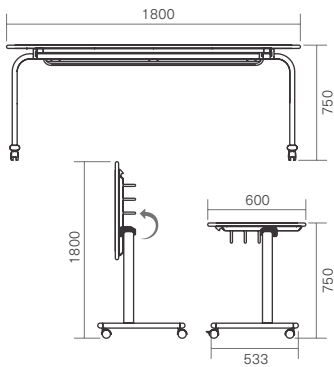

KUMI MT



PRODUCT SPECIFICATIONS

Dimension W x D x H (mm)	2400 X 1200 X 750
Contain per Carton	-
Table Top Material	Particle Board Solid Laminated with HPL
Frame Colour	White Doff & Black Doff
Frame Finishing	Powder Coating Doff

TABLE COLOUR OPTIONS

Particle Board + Laminated HPL

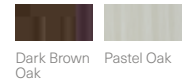

Dark Brown Oak Pastel Oak

PRODUCT DIMENSION

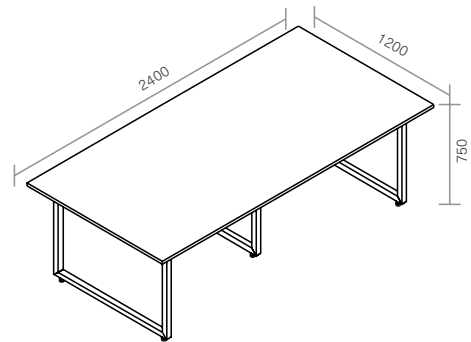

PRODUCT SPECIFICATIONS

Dimension W x D x H (mm)	1800 X 700 X 750
	900 X 600 X 750
Contain per Carton	-
Table Top Material	Particle Board Solid laminated with HPL
Frame Colour	White Doff & Black Doff
Frame Finishing	Powder Coating Doff

TABLE COLOUR OPTIONS

Particle Board + Laminated HPL

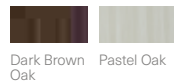

Dark Brown Oak Pastel Oak

PRODUCT DIMENSION

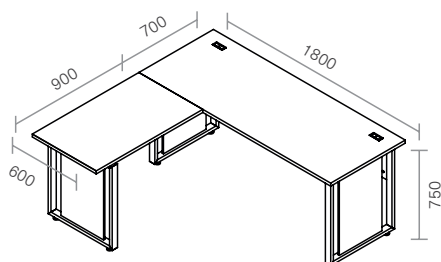

KUMI ED



KUMI MD



PRODUCT SPECIFICATIONS

Dimension W x D x H (mm)	1400 X 700 X 750
Table Top Material	Particle Board Solid Laminated with HPL
Contain per Carton	-
Frame Colour	White Doff & Black Doff
Frame Finishing	Powder Coating Doff

TABLE COLOUR OPTIONS

Particle Board + Laminated HPL		
	Dark Brown Oak	Pastel Oak

PRODUCT DIMENSION

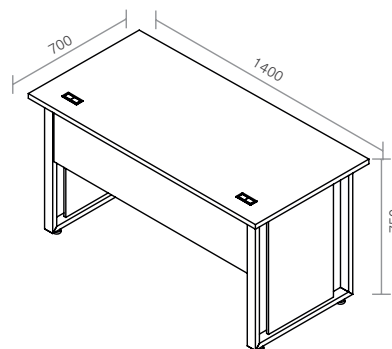

PRODUCT SPECIFICATIONS

Dimension W x D x H (mm)	1200 X 700 X 750
Contain per Carton	-
Table Top Material	Particle Board Solid Laminated with HPL
Frame Colour	White Doff & Black Doff
Frame Finishing	Powder Coating Doff

TABLE COLOUR OPTIONS

Particle Board + Laminated HPL		
	Dark Brown Oak	Pastel Oak

PRODUCT DIMENSION

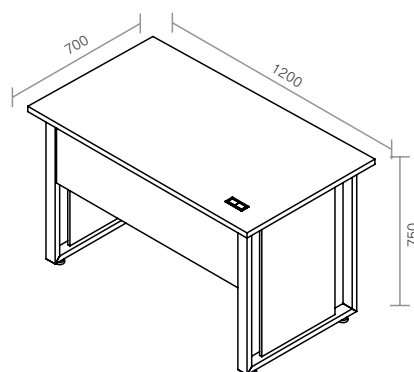

KUMI SD



KUMI FD



PRODUCT SPECIFICATIONS

Dimension W x D x H (mm)	600 X 1200 X 750
Contain per Carton	1
Frame Finishing	Powder Coating
Frame Colour	Black & White
Table Top Material	Particle Board + HPL

TABLE COLOUR OPTIONS

Particle Board +
HPL

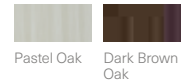

PRODUCT DIMENSION

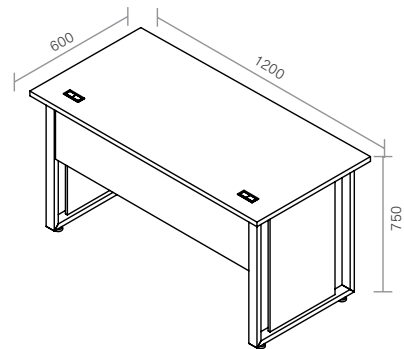

PRODUCT SPECIFICATIONS

Dimension W x D x H (mm)	420 X 500 X 600
Contain per Carton	1

PANEL COLOUR OPTIONS

Particle Board
covered with PVC

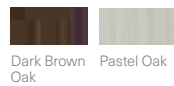

PRODUCT DIMENSION

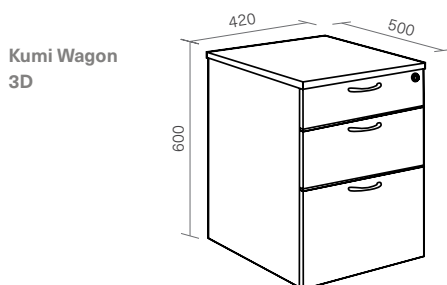
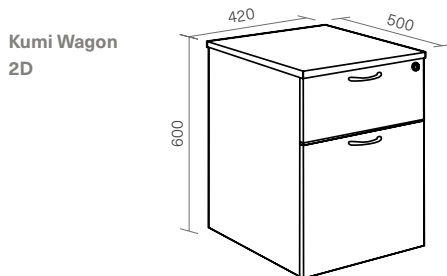

KUMI WAGON 2D & 3D



Kumi Wagon 2D



Kumi Wagon 3D

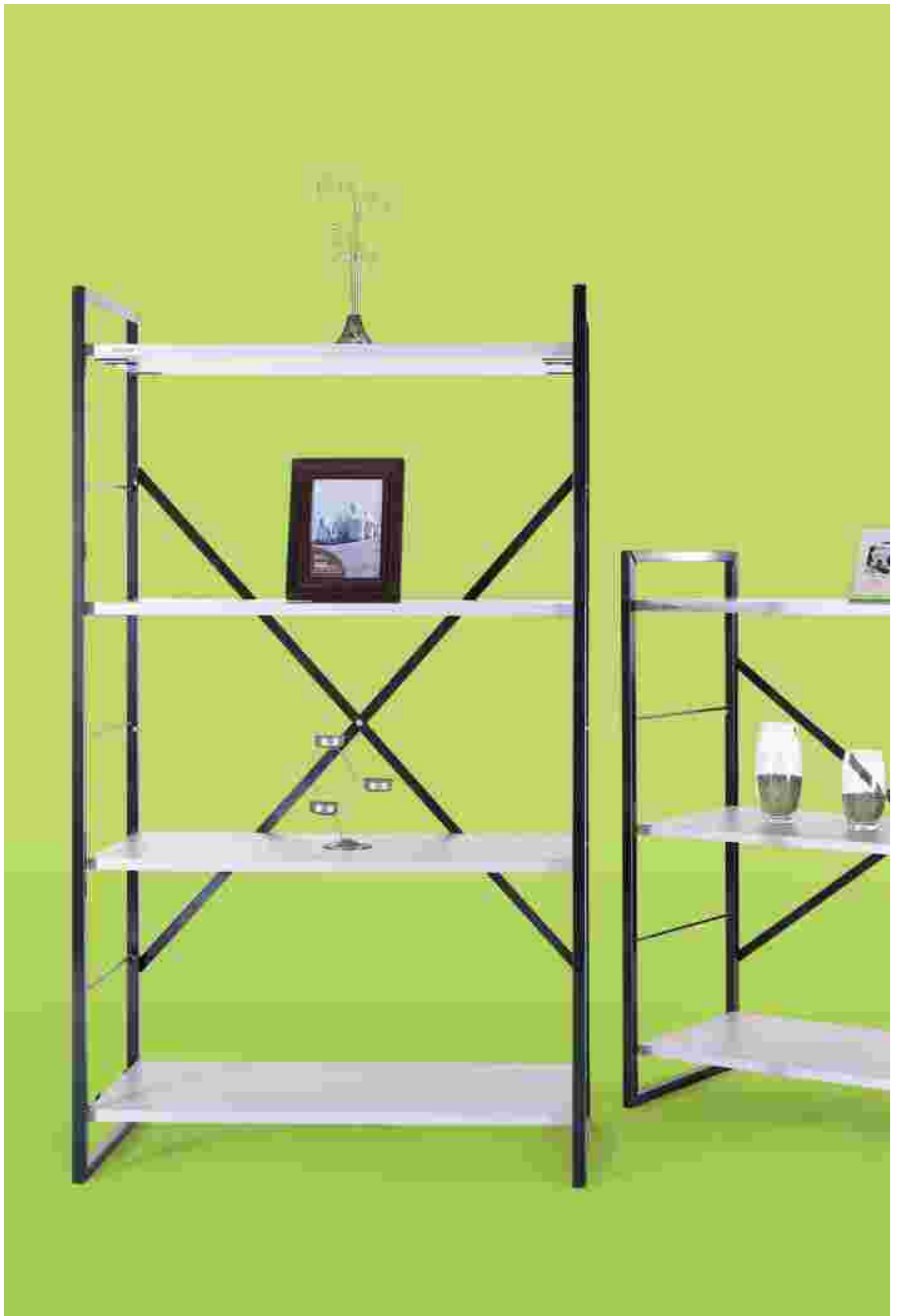



Inexto H-1800 SW
112



Inexto H-1320 SW/SL
112



Inexto H-1020 SW/SL
112



Inexto H-720
112



Inexto Locker 3D
113



Inexto Locker 4D
113



CK-810
114



CK-1800
114



Shelf 7012 PS 7012 / BASE
114



Shelf 7090 PS 7090 / BASE
115



Shelf 7070 PS 7070 / BASE
115



Maple Rack L
116



Maple Rack M
117



Maple Rack S
117



Executive Rack L
118



Grey Rack L
118



Executive Rack M
119

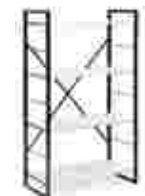

Grey Rack M
119



Executive Rack S
119



Grey Rack S
119

INEXTO SERIES



Inexto Series



Inexto H-720



Inexto H-1020 SW (swing door)
Inexto H-1020 SL (sliding door)



Inexto H-1320 SW (swing door)
Inexto H-1320 SL (sliding door)



Inexto H-1800 SW
(swing door)

PRODUCT DIMENSION

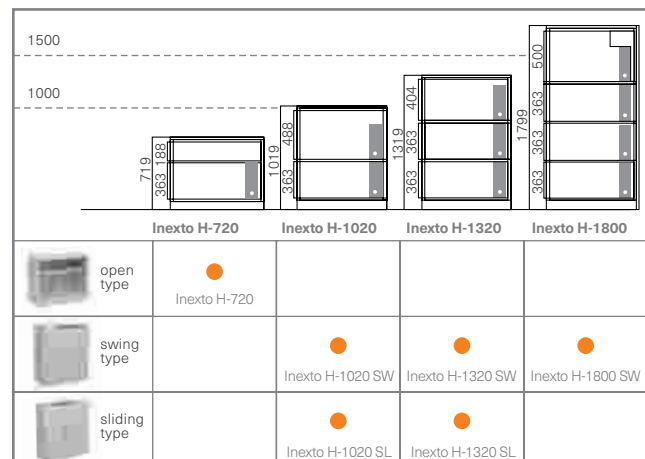

PRODUCT SPECIFICATIONS

Dimension W x D (mm) 900 X 450
Main Unit Steel with Powder Coating
Handle ABS

COLOUR OPTION

Steel with PC 
 Light Grey

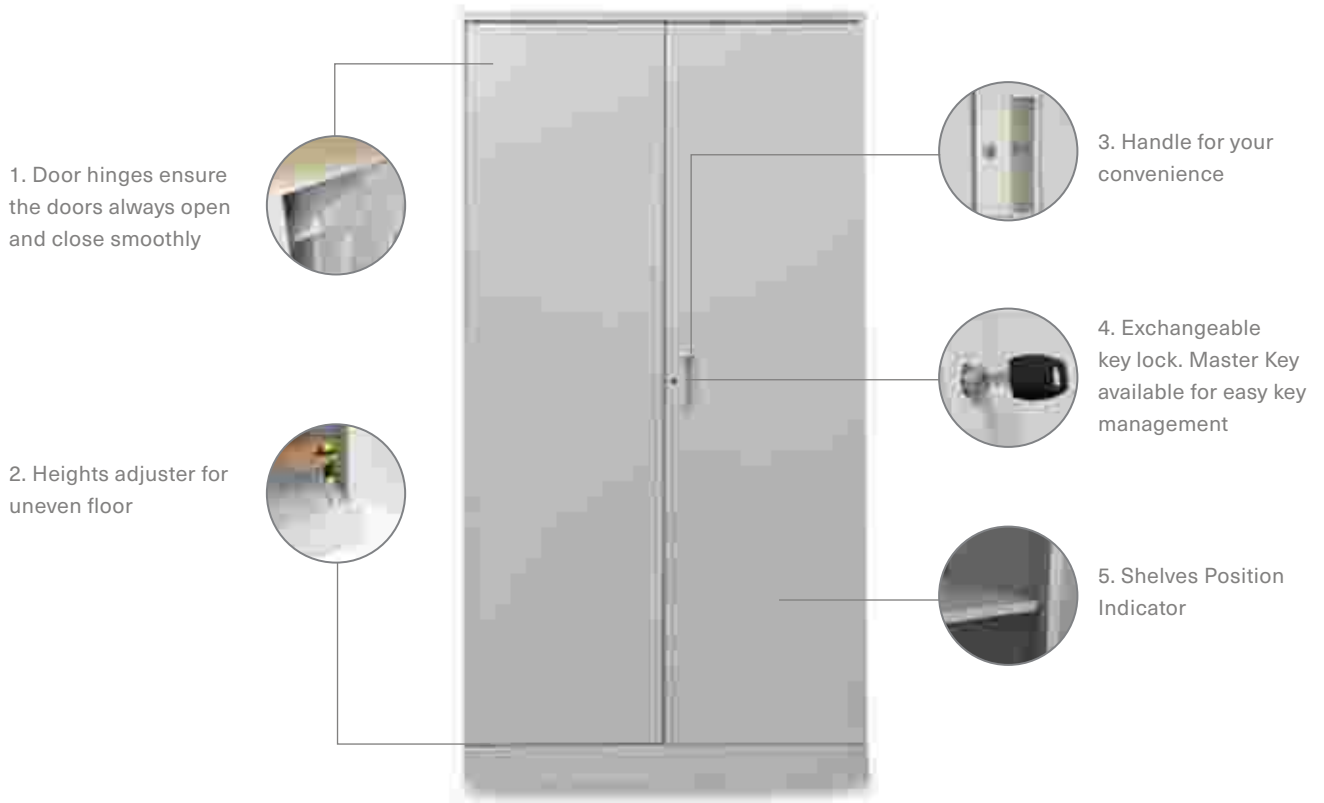

PRODUCT SPECIFICATIONS

Dimension W x D x H (mm) 300 X 450 X 1800
 Main Unit Steel with Powder Coating

COLOUR OPTION

Steel with PC  Light Grey

PRODUCT DIMENSION

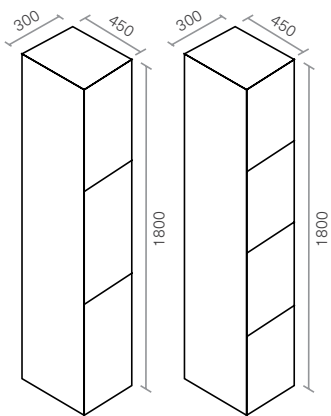

INEXTO LOCKER



Inexto Locker 3D



Inexto Locker 4D

CK-810 & CK-1800



CK-810



CK-1800

PRODUCT SPECIFICATIONS

Dimension W x D x H (mm)	800 X 400 X 950 (CK-810)
	800 X 400 X 1800 (CK-1800)
Contain per Carton	1

PANEL COLOUR OPTIONS

Particle Board covered with PVC

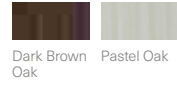

Dark Brown Oak Pastel Oak

PRODUCT DIMENSION

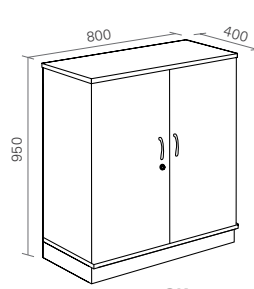

CK-810

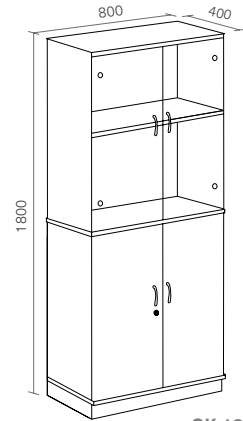

CK-1800

PRODUCT SPECIFICATIONS

Dimension W x D x H (mm)	800 X 400 X 1280
Contain per Carton	1

COLOUR OPTIONS

Particle Board covered with PVC



Grey Maple

PRODUCT DIMENSION

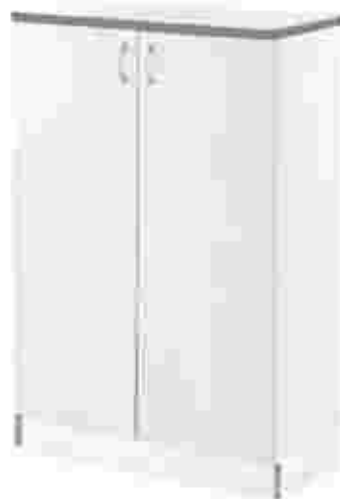
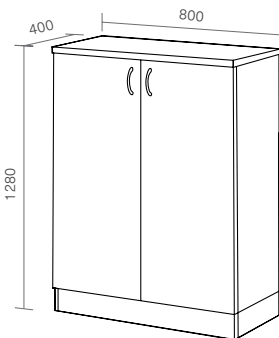

SHELF-7012



SHELF-7090



PRODUCT SPECIFICATIONS

Dimension W x D x H (mm) 800 X 400 X 980
Contain per Carton 1

COLOUR OPTIONS

Particle Board covered
with PVC



PRODUCT DIMENSION

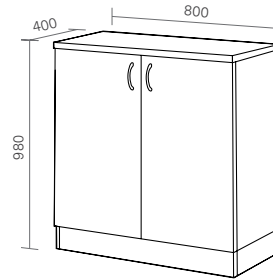

PRODUCT SPECIFICATIONS

Dimension W x D x H (mm) 800 X 400 X 850
Contain per Carton 1

COLOUR OPTIONS

Particle Board covered
with PVC



PRODUCT DIMENSION

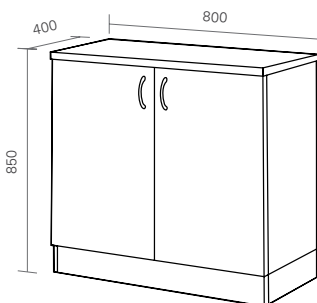

SHELF-7070



MAPLE RACK L



PRODUCT SPECIFICATIONS

Dimension W x D x H (mm)	600 X 400 X 1800
Weight per Piece (kg)	30-32
Contain per Carton	1
Frame Colour	Silver
Frame Finishing	Powder Coating

COLOUR OPTION

Particle Board covered with PVC



Maple

PRODUCT DIMENSION

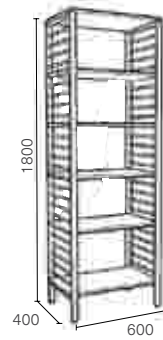

Maple Rack

MAPLE RACK M



PRODUCT SPECIFICATIONS

Dimension W x D x H (mm)	600 X 400 X 1600
Weight per Piece (kg)	25-27
Contain per Carton	1
Frame Colour	Silver
Frame Finishing	Powder Coating

COLOUR OPTION

Particle Board covered with PVC



PRODUCT DIMENSION

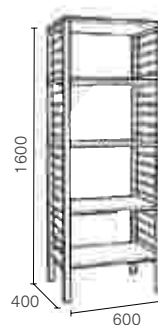

PRODUCT SPECIFICATIONS

Dimension W x D x H (mm)	600 X 400 X 1100
Weight per Piece (kg)	21-23
Contain per Carton	1
Frame Colour	Silver
Frame Finishing	Powder Coating

COLOUR OPTION

Particle Board covered with PVC



PRODUCT DIMENSION

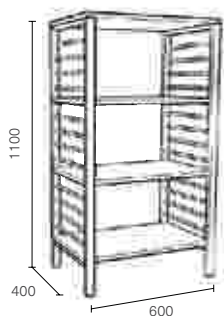

MAPLE RACK S



GREY RACK L / EXECUTIVE RACK L

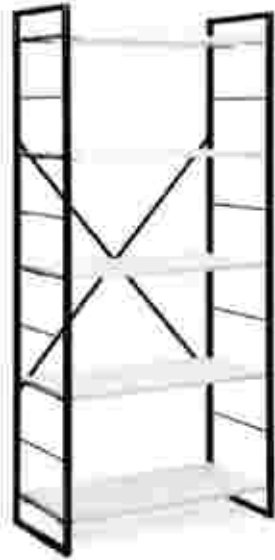

Grey Rack L



Executive Rack L

PRODUCT SPECIFICATIONS

Dimension W x D x H (mm)	800 X 400 X 1800
Weight per Piece (kg)	21-23 (Grey Rack) 30-32 (Exe. Rack)
Contain per Carton	1
Frame Colour	Black
Frame Finishing	Powder Coating

COLOUR OPTIONS

Particle Board (Grey Rack L)
Particle Board + MDF covered with PVC (Exe. Rack L)



PRODUCT DIMENSION

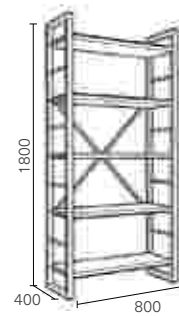

Executive Rack Application

GREY RACK M / EXECUTIVE RACK M



Grey Rack M



Executive Rack M

PRODUCT SPECIFICATIONS

Dimension W x D x H (mm)	800 X 400 X 1400
Weight per Piece (kg)	16-18 (Grey Rack) 26-28 (Exe. Rack)
Contain per Carton	1
Frame Colour	Black
Frame Finishing	Powder Coating

COLOUR OPTIONS

Particle Board (Grey Rack L)
Particle Board + MDF covered with PVC (Exe. Rack L)

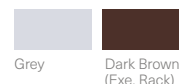

PRODUCT DIMENSION

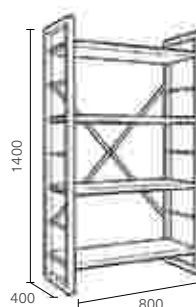

PRODUCT SPECIFICATIONS

Dimension W x D x H (mm)	800 X 400 X 1000
Weight per Piece (kg)	12-14 (Grey Rack) 17-19 (Exe. Rack)
Contain per Carton	1
Frame Colour	Black
Frame Finishing	Powder Coating

COLOUR OPTIONS

Particle Board (Grey Rack L)
Particle Board + MDF covered with PVC (Exe. Rack L)

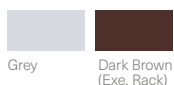

PRODUCT DIMENSION

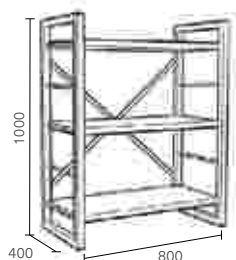

GREY RACK S / EXECUTIVE RACK S



Executive Rack S

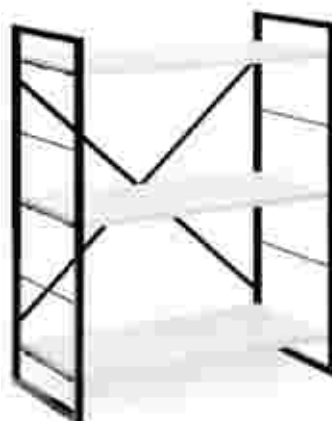

Grey Rack S





Fuji DS
122



Fuji SS
123



TU-6012 Low
124



Aso DS
124



Aso SS
125



T-5512
126



KT-01 Cavis
126



KT-02 Cavis
127



KT-02 Olive
128



ATC-01
128



Kogu KT-03
129



Kogu PC & PP(PU) / Kogu TS
129



FUJI DS

PRODUCT SPECIFICATIONS

Dimension W x D x H (mm)	1300 X 910 X 1000
Weight per Piece (kg)	24.6
Contain per Carton	1
Frame Material	Steel Pipe
Frame Finishing	Powder Coating, Chrome Plating

COLOUR OPTIONS & UPHOLSTERY MATERIAL

PVC Oscar			
	So3 Red	So7 Black	So10 White

PRODUCT DIMENSION

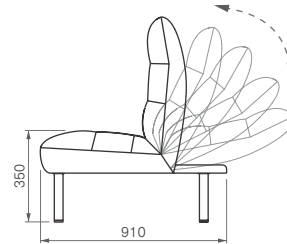
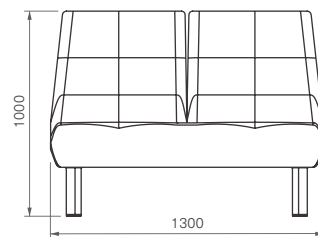

FUJI SS



PRODUCT SPECIFICATIONS

Dimension W x D x H (mm)	675 X 910 X 1000
Weight per Piece (kg)	16.6
Contain per Carton	1
Frame Material	Steel Pipe
Frame Finishing	Powder Coating

COLOUR OPTIONS & UPHOLSTERY MATERIAL

PVC Oscar			
	So3 Red	So7 Black	So10 White

PRODUCT DIMENSION

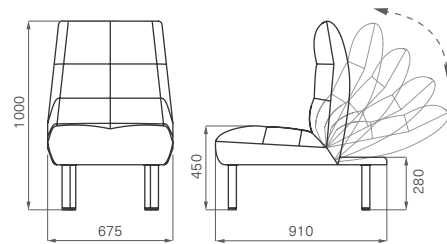

Fuji SS





TU-6012 LOW



PRODUCT SPECIFICATIONS

Dimension W x D x H (mm)	1200 X 600 X 450-460
Weight per Piece (kg)	15.2
Contain per Carton	1
Frame Finishing	Powder Coating

COLOUR OPTIONS

Particle Board + MDF covered with PVC



Dark Brown

PRODUCT DIMENSION

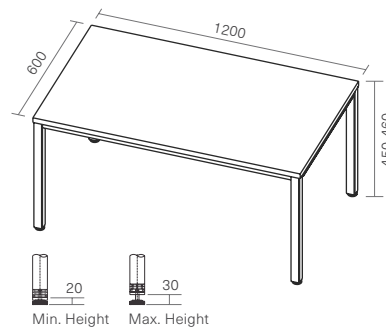

PRODUCT SPECIFICATIONS

Dimension W x D x H (mm)	1300 X 913 X 1000
Weight per Piece (kg)	18.7
Contain per Carton	1
Frame Material	Steel Pipe
Frame Finishing	Powder Coating

COLOUR OPTIONS & UPHOLSTERY MATERIAL

PVC Oscar



So3 Red So7 Black

PRODUCT DIMENSION

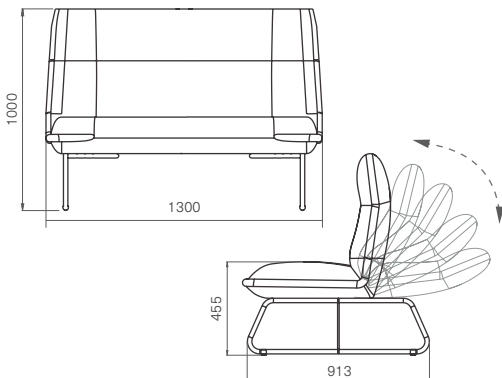

ASO DS





PRODUCT SPECIFICATIONS

Dimension W x D x H (mm)	780 X 913 X 1000
Weight per Piece (kg)	16.6
Contain per Carton	1
Frame Material	Steel Pipe
Frame Finishing	Powder Coating

ASO SS

COLOUR OPTIONS & UPHOLSTERY MATERIAL



PRODUCT DIMENSION

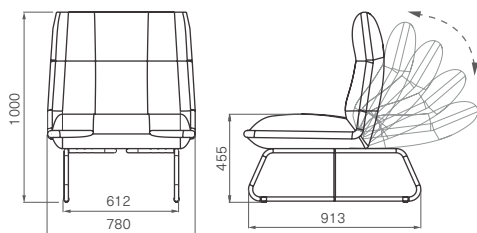



T-5512



PRODUCT SPECIFICATIONS

Dimension W x D x H (mm)	1200 X 550 X 450-460
Weight per Piece (kg)	24
Contain per Carton	1
Frame Colour	Ivory, Light Grey
Frame Finishing	Powder Coating

COLOUR OPTIONS

Particle Board + MDF covered with PVC



PRODUCT DIMENSION

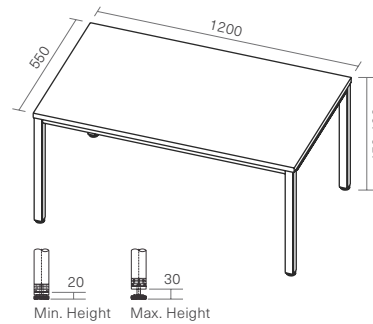

Table T-5512 + KT-02 Olive 3

KT-01 CAVIS

PRODUCT SPECIFICATIONS

Dimension W x D x H (mm)	1450 X 535 X 780 (3 Seats)
	2060 X 535 X 780 (4 Seats)
Frame Color	Ivory
Frame Finishing	Powder Coating

COLOUR OPTIONS & UPHOLSTERY MATERIAL

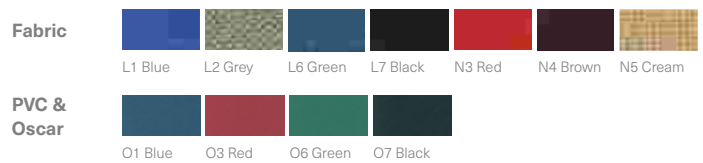

PRODUCT DIMENSION

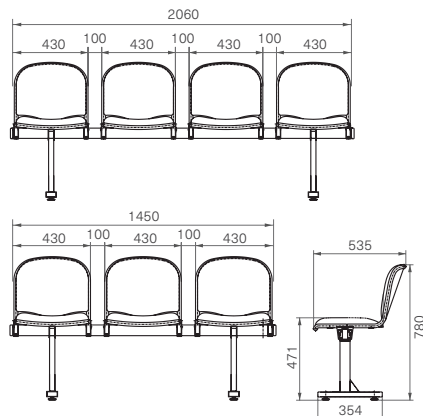

KT-01 Cavis 4

KT-02 CAVIS



KT-02 Cavis 4













KT-02 Cavis 3
+ Table T-5512

PRODUCT SPECIFICATIONS

Dimension W x D x H (mm)	1771 X 498 X 780 (3 Seats)
	2298 x 498 x 780 (4 Seats)
Frame Colour	Grey
Frame Finishing	Powder Coating

COLOUR OPTIONS & UPHOLSTERY MATERIAL

Fabric				
	L1 Blue	L2 Grey	L6 Green	L7 Black
				
	N3 Red	N4 Brown	N5 Cream	
PVC & Oscar				
	O1 Blue	O3 Red	O6 Green	O7 Green

PRODUCT DIMENSION

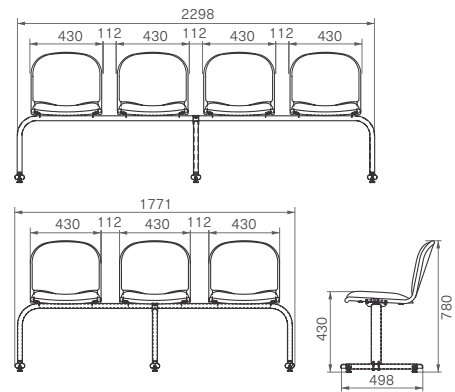

KT-01 Cavis



KT-01 Cavis 3



KT-01 Cavis 3



KT-02 OLIVE



KT-02 Olive 4



KT-02 Olive 3
+ Table T-5512

PRODUCT SPECIFICATIONS

Dimension W x D x H (mm)	1771 X 498 X 798 (3 Seats)
	2298 X 498 X 798 (4 Seats)
Frame Colour	Grey
Frame Finishing	Powder Coating

COLOUR OPTIONS & SEAT-BACK MATERIAL

Plastic				
	White	Beige	Grey	Light Grey
	Red	Light Green	Light Blue	

PRODUCT DIMENSION

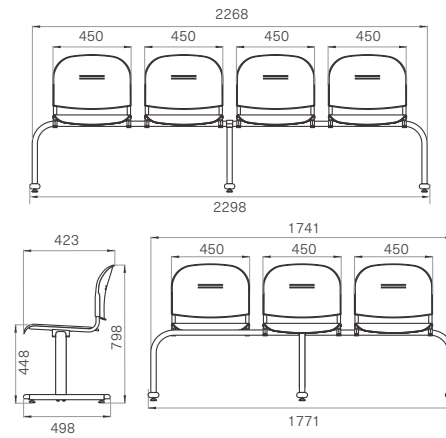

PRODUCT SPECIFICATIONS

Dimension W x D x H (mm)	1160 X 679 X 865
Contain per Carton	2
Frame Material	Square Pipe
Frame Finishing	Powder Coating

COLOUR OPTIONS & UPHOLSTERY MATERIAL

Fabric		
	LE 1 Blue	LE 7 Black

PRODUCT DIMENSION

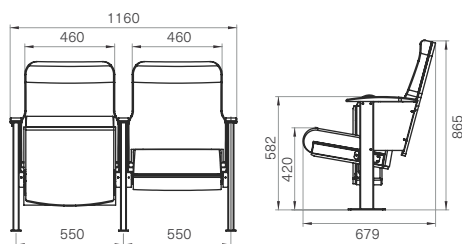

ATC-01



KOGU KT-03



PRODUCT SPECIFICATIONS

Dimension W x D x H (mm)	1300 X 650 X 870 (2 Seats)
	1900 X 650 X 870 (3 Seats)
	2500 X 650 X 870 (4 Seats)
Frame Colour	Grey
Frame Finishing	Powder Coating

PRODUCT DIMENSION

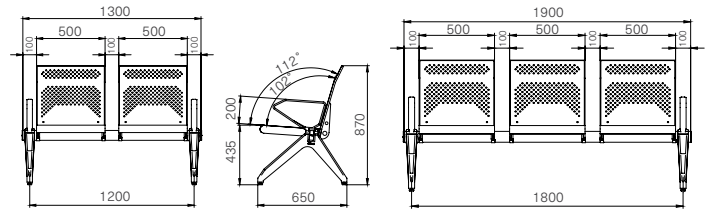

COLOUR OPTIONS

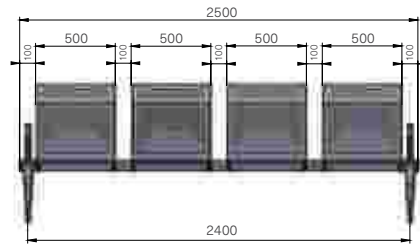
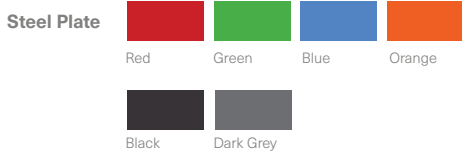

PRODUCT SPECIFICATIONS

Dimension W x D x H (mm)	1300 X 650 X 870 (2 Seats) Kogu PP/PC
	1900 X 650 X 870 (3 Seats) Kogu PP/PC
	2500 X 650 X 870 (4 Seats) Kogu PP/PC
	1520 X 508 X 450 (3 Seats) Kogu TS
Contain per Carton	1
Frame Finishing	Powder Coating
Frame Colour	Silver (Kogu PC & PP), Grey (Kogu TS)
Seat-back Material	Plywood + Urethane Foam + Oscar (Kogu PC) Plate + PU (Kogu PP)
Seat Material	Plate (Kogu TS)

KOGU PC & PP(PU) / KOGU TS

COLOUR OPTIONS KOGU PC & KOGU TS

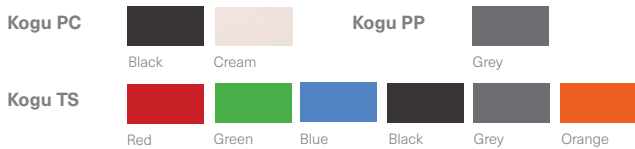

PRODUCT DIMENSION

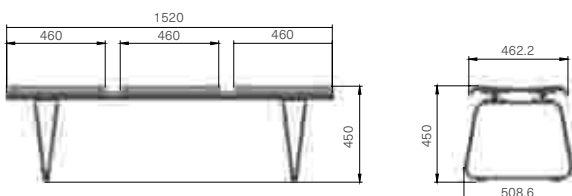



DELICATE CREATION

11

ACCESSORIES



TM-01

* Suitable for Meeting Chair (Cozy, Jasmine C-111), Kasai, Sankei C-371, Sankei C-395, Yuki



TM-02

* Suitable for Hotel & Restaurant Chair (Caesar, Jiro, Hanako, Taro, Sakata)



TF-01

* Suitable for Folding Chair (CAL, Cosmo 541/542, Daishogun, Daishogun Plus, Yamato AA, Yamato NN, Yamato HAA, Yamato NP, Yasuka Sliding)



TF-02

* Suitable for Folding Chair (CAL, Cosmo 541/542, Daishogun, Daishogun Plus, Yamato AA, Yamato NN, Yamato HAA, Yamato NP, Yasuka Sliding)

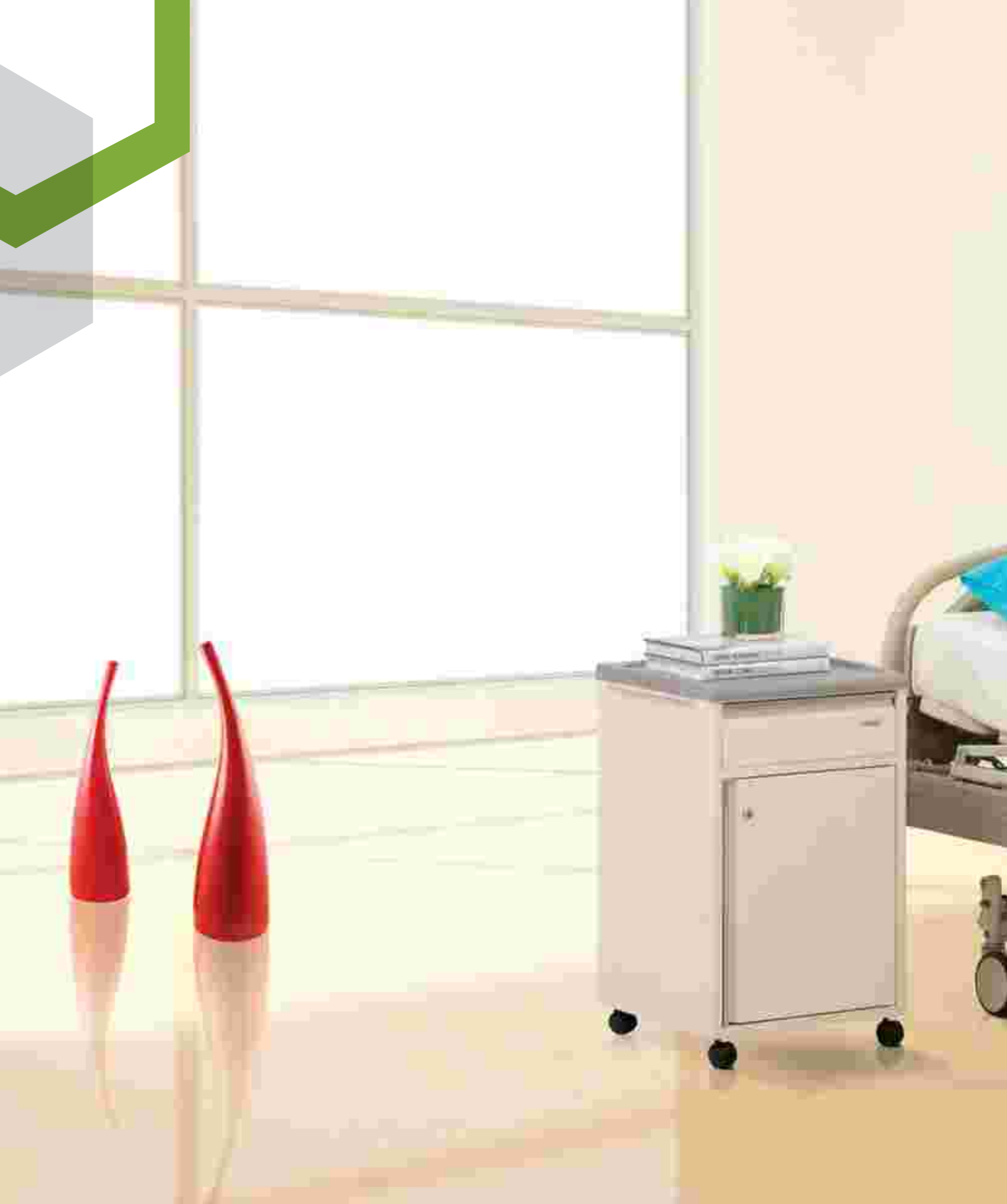



HANDLING REHABILITATION



Ergonoline Bed
CB-0733 T
136



(Three Motors Bed)
CB-3300 D ST, D JP & T DX
140



(Three Cranks Bed)
CB-3003 D ST, D JP & D DX
142



(One Cylinder Bed Two Crank)
CB-3012 D ST, D JP & D4 DX
144



(One Cylinder Bed One Crank)
CB-3011 D ST, D JP & D DX
146



(One Cylinder Bed One Crank)
CB-135 D ST, D JP & CB-535 D ST
148



Wider Bed
150



CB-003 Stretcher
151



CB-002 Gear Bed Four Steps
152



CB-001 Standard Bed
153

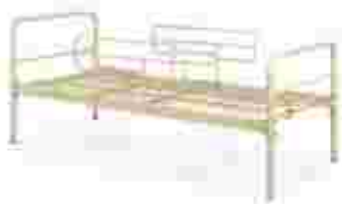

CB-501 Wire Mesh Bottom
153



Baby Cot
154



Examination Bed
154



Head Board & Foot Board Panel
156



Mattress
158



Side Rails
159



Irrigator Bar & Table Panel
160



Other Equipments
161



OPERATION SYSTEM

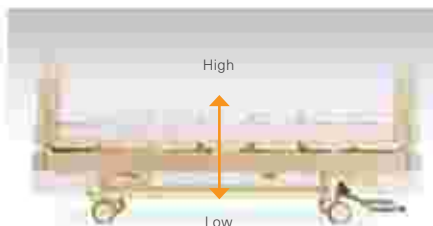
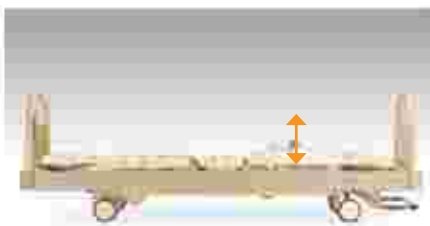
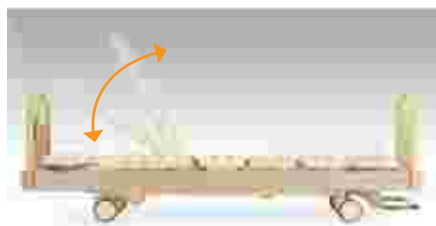

Body support line which consists of seven jointly of strong steel panels ergonomically supports the user's body balance evenly.

CB-0733 T

OPTION



CB-0733 T
with H/F Board BD-003

ERGONOLINE BED

FEATURES & PROCEDURES



Head/foot board
panel dismantle

Head/foot board panel
installation

LOCKING OPERATION SYSTEM

The system will lock or unlock securely the four casters totally at one stop action.



Lock

Unlock

REMOTE SYSTEM

Remote control system enables the users to adjust his most comfortable position.



PRODUCT SPECIFICATIONS

Operating System	Adjustable Hi-Lo, back raise and foot raise automatic by motor
Accessories	Folding Side Rail (FSR-001)
Lock System	Total Lock System
Weight (kg)	Approx. 120 - 150
Frame Finishing	Powder Coating
Frame Material	Steel
Frame Color	Ivory
Dimension (mm)	Bed (W 950, L 2190, H 716-1046) H/F Board (W 950)

PRODUCT DIMENSION

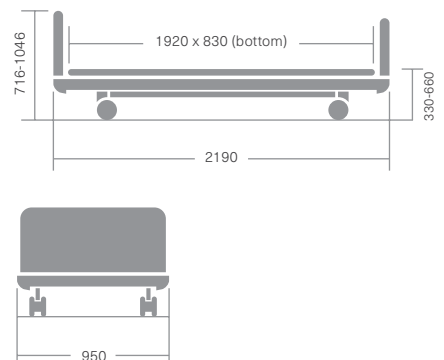



CB-3300 T

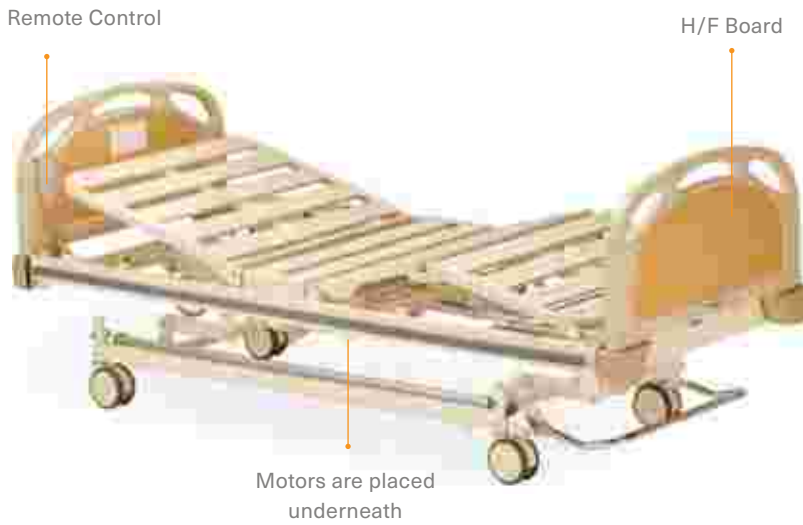

PRODUCT KNOWLEDGE



3000 Series	Motor	Cylinder	Crank	Lock System
3	3	0	0	T*

The table above shows features of the CB-3300 T bed, which determines the product's naming convention. The CB-3300 T bed is operated with 3 motors to adjust its height levels, and a single total lock system to provide stability and secure parking.

T TOTAL LOCK SYSTEM

CB-3003 D

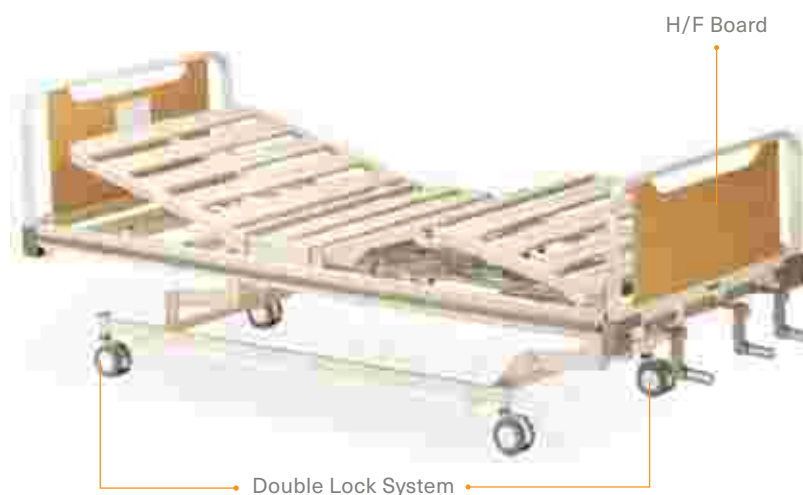

PRODUCT KNOWLEDGE



3000 Series	Motor	Cylinder	Crank	Lock System
3	0	0	3	D*

The table above shows features of the CB-3003 D bed, which determines the product's naming convention. The CB-3003 D bed is operated using 3 cranks to adjust its height levels, and double lock system to provide stability and secure parking.

D DOUBLE LOCK SYSTEM

CB-3012 D

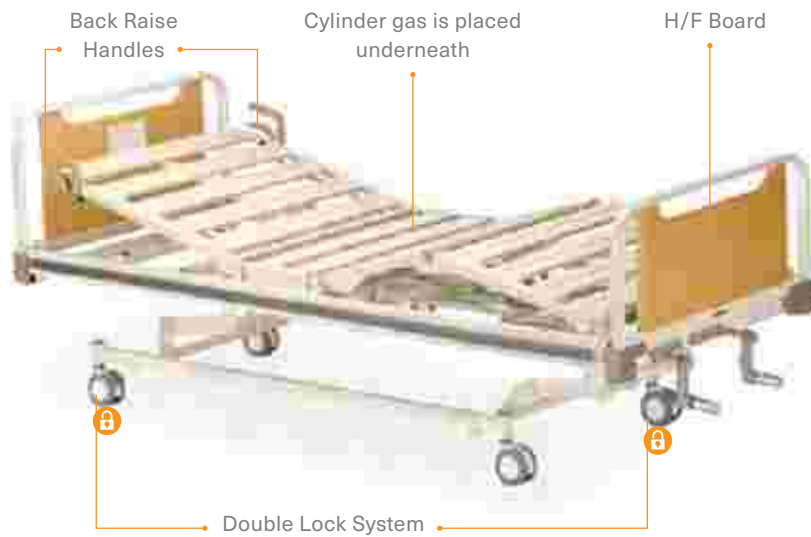

DX
CB-3012 D DX



ST
CB-3012 D ST



JP
CB-3012 D JP

PRODUCT KNOWLEDGE



Crank

3000 Series	Motor	Cylinder	Crank	Lock System
3	0	1	2	D ⁺

The table above shows features of the CB-3012 D bed, which determines the product's naming convention. The CB-3012 D bed is operated using 2 cranks and a cylinder gas control to adjust its height levels, and double lock system to provide stability and secure parking.

D DOUBLE LOCK SYSTEM

D⁺ FOUR LOCK SYSTEM

CB-3011 D

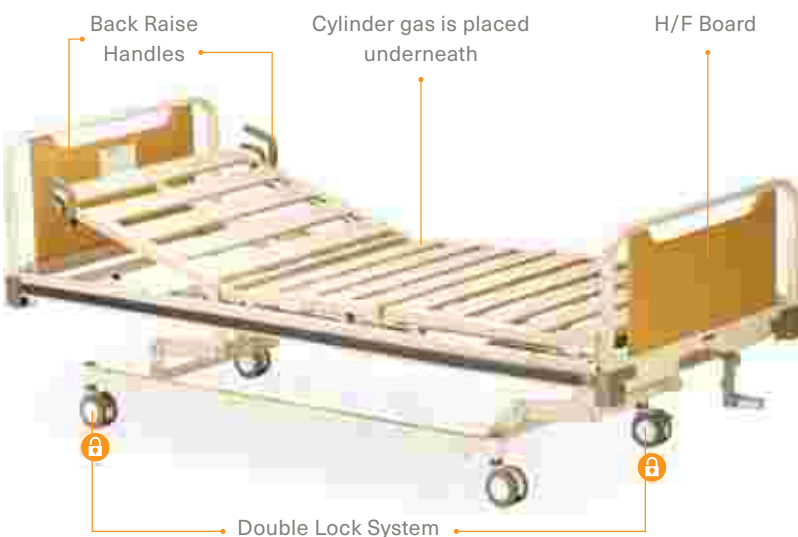

DX
CB-3011 D DX



ST
CB-3011 D ST



JP
CB-3011 D JP

PRODUCT KNOWLEDGE



Crank

3000 Series	Motor	Cylinder	Crank	Lock System
3	0	1	1	D ⁺

The table above shows features of the CB-3011 D bed, which determines the product's naming convention. The CB-3011 D bed is operated using 1 crank and a cylinder gas control to adjust its height levels, and double lock system to provide stability and secure parking.

D DOUBLE LOCK SYSTEM



OPERATION SYSTEM

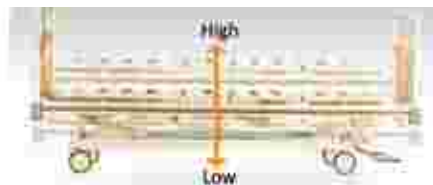

Body support line which consists of four joints of strong steel panels ergonomically supports the user's body balance evenly.

CB-3300 D ST CB-3300 D JP CB-3300 T DX

OPTION



CB-3300 D ST



CB-3300 D JP



CB-3300 T DX

PRODUCT SPECIFICATIONS

Operating System	Adjustable Hi-Lo, back raise and foot raise automatic by motor
Weight (kg)	Approx. 90
Accessories	Side Rail (CSR-001, CSR-002, CSR-003) Folding Side Rail (FSR-001)
Frame Finishing	Powder Coating
Lock System	Total Lock System (CB-3300 T) & Double Lock System (CB-3300 D)
Frame Color	Ivory
Frame Material	Steel
Dimension (mm)	Bed (W 932, L 2141, H 672-1012), H/F Board (W 932)

THREE MOTORS BED

FEATURES & PROCEDURES



Head/foot board panel dismantle

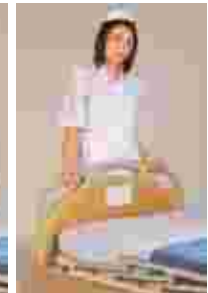

Head/foot board panel installation

LOCKING OPERATION SYSTEM

The system will lock or unlock securely the four casters totally at one stop action.

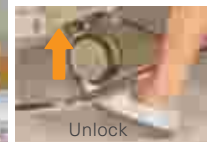

Irrigator bar installation (applicable for every nursing bed)

REMOTE SYSTEM

Remote control system enables the users to adjust his most comfortable position.



PRODUCT DIMENSION

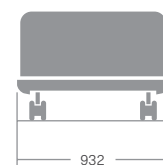
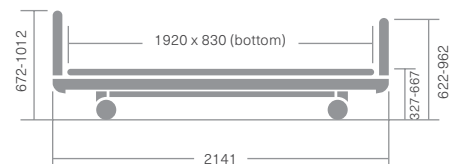

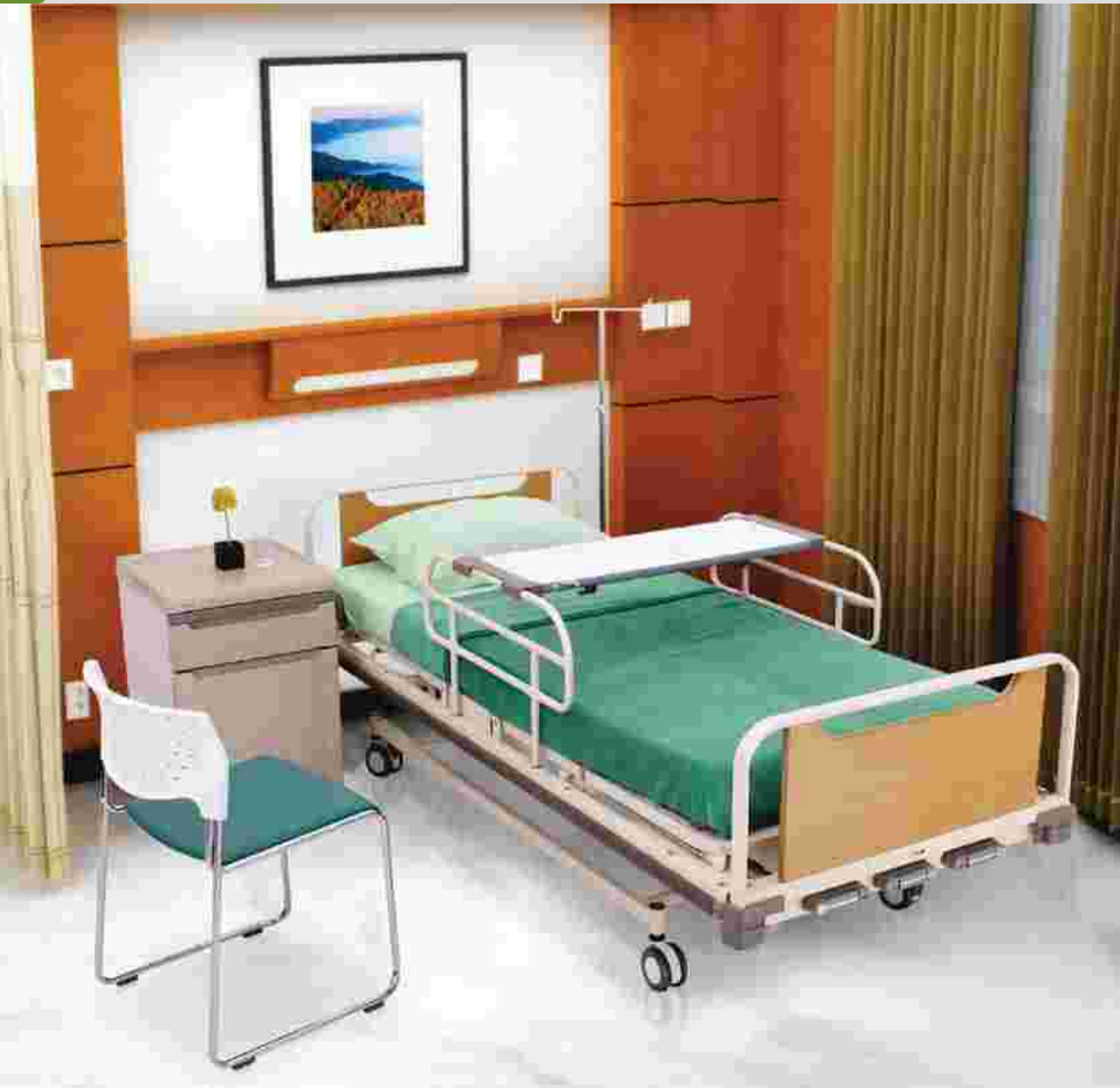

OPERATION SYSTEM

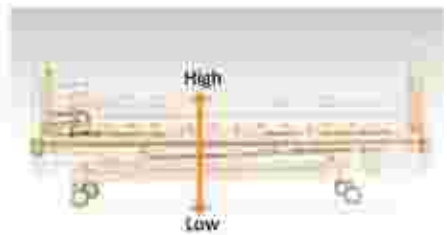

Body support line which consists of four joints of strong steel panels ergonomically supports the user's body balance evenly.

CB-3003 D ST CB-3003 D JP CB-3003 D DX

OPTION



THREE CRANKS BED

FEATURES & PROCEDURES



Head/foot board panel dismantle



Head/foot board panel installation

LOCKING OPERATION SYSTEM

An unique eye catching foldable crank is designed to give high-low bed adjustment.



Crank operation system



Side rail compartment (available in every nursing bed)

CASTER OPERATION SYSTEM

Independent lock caster (one at front and one at back of the bed) provides stability and secure parking.

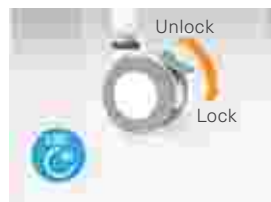

PRODUCT SPECIFICATIONS

Operating System	Adjustable Hi-Lo, back raise and foot raise manual by crank
Weight (kg)	Approx. 90
Accessories	Side Rail (CSR-001, CSR-002, CSR-003) Folding Side Rail (FSR-001)
Frame Finishing	Powder Coating
Lock System	Double Lock System
Frame Color	Ivory
Frame Material	Steel
Dimension (mm)	Bed (W 932, L 2141, H 654-994), H/F Board (W 932)

PRODUCT DIMENSION

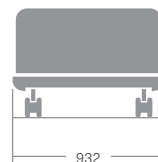
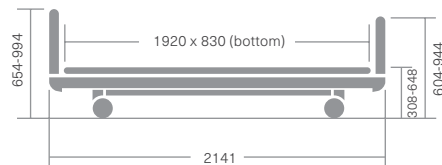

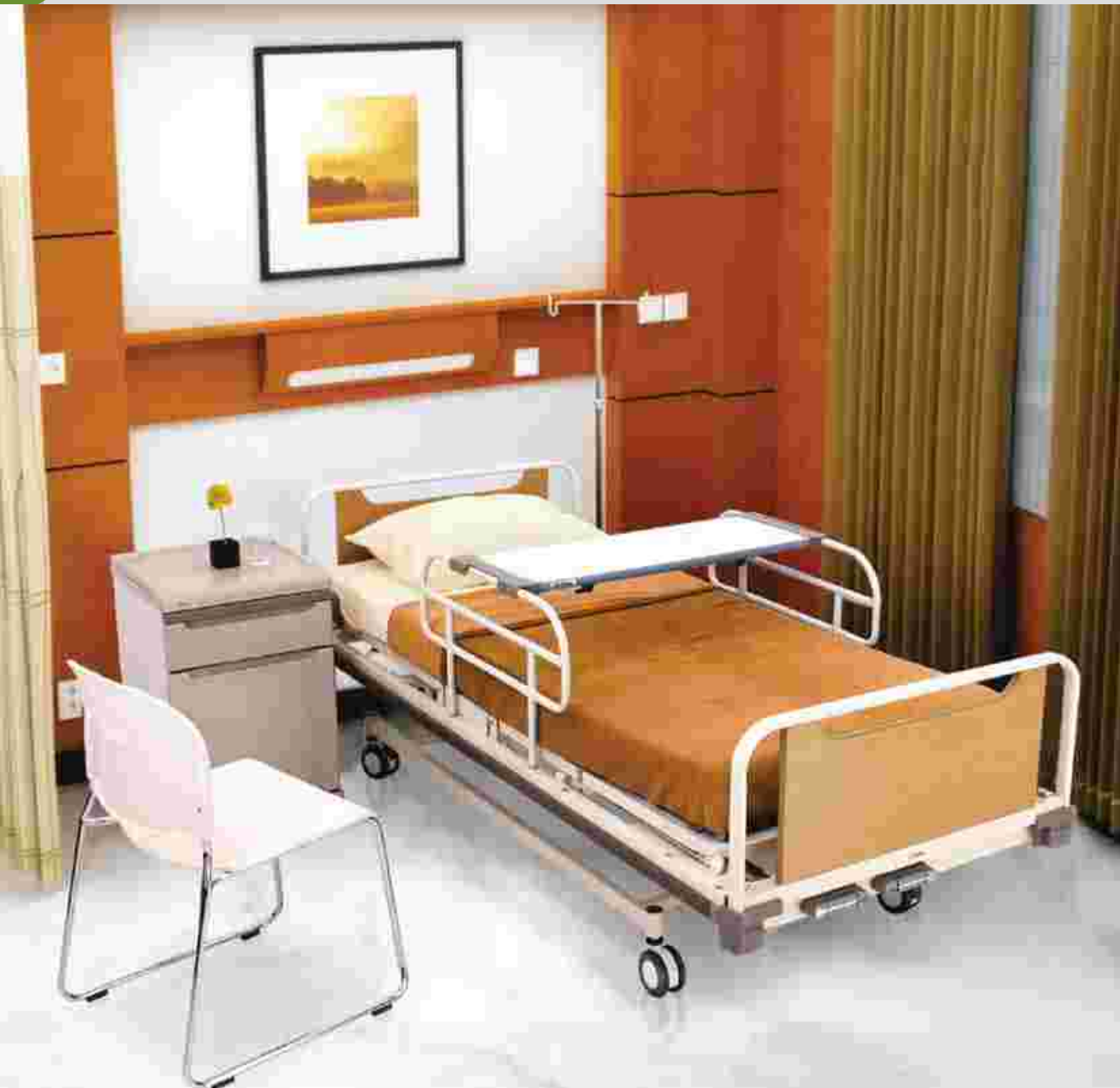

OPERATION SYSTEM

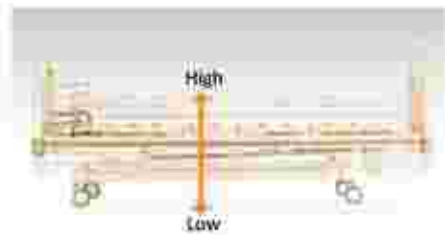

Body support line which consists of four jointly of strong steel panels ergonomically supports the user's body balance evenly.

CB-3012 D ST CB-3012 D JP CB-3012 D4 DX

OPTION

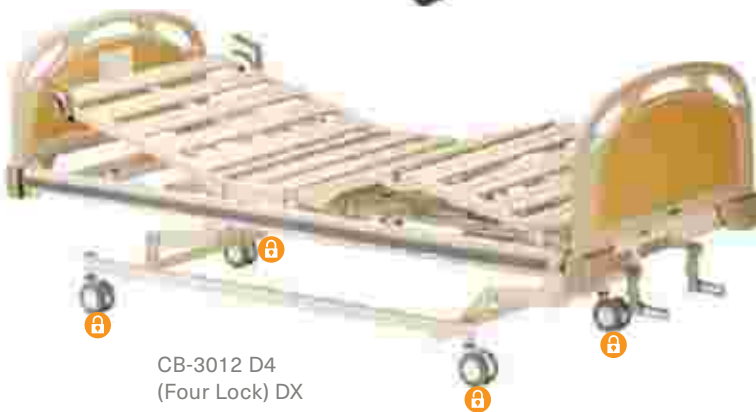

ONE CYLINDER TWO CRANKS BED

FEATURES & PROCEDURES



Head/foot board panel dismantle



Head/foot board panel installation

LOCKING OPERATION SYSTEM

An unique eye catching foldable crank is designed to give high-low bed adjustment.



Crank operation system

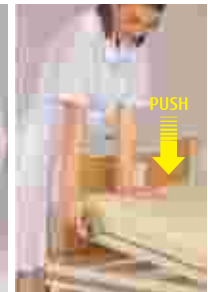

Back raise adjustment system

CASTER OPERATION SYSTEM

Independent lock caster (one at front and one at back of the bed) provides stability and secure parking.

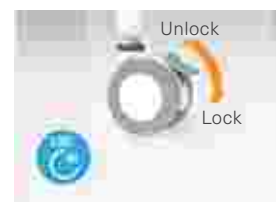

PRODUCT SPECIFICATIONS

Operating System	Adjustable Hi-Lo, back raise and foot raise manual by crank, adjustable back raise with cylinder gas control
Accessories	Side Rail (CSR-001, CSR-002, CSR-003) & Folding Side Rail (FSR-001)
Weight (kg)	Approx. 90
Lock System	Double Lock System (CB-3012 D, CB-7012 D), Four Lock System (CB-3012 D4)
Frame Finishing	Powder Coating
Frame Color	Ivory
Frame Material	Steel
Dimension (mm)	Bed (W 932, L 2141, H 654-994), H/F Board (W 932)

PRODUCT DIMENSION

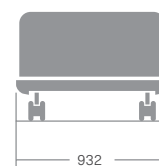
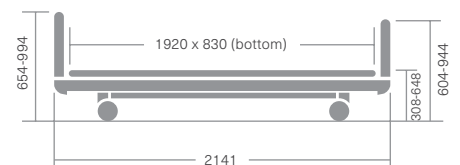

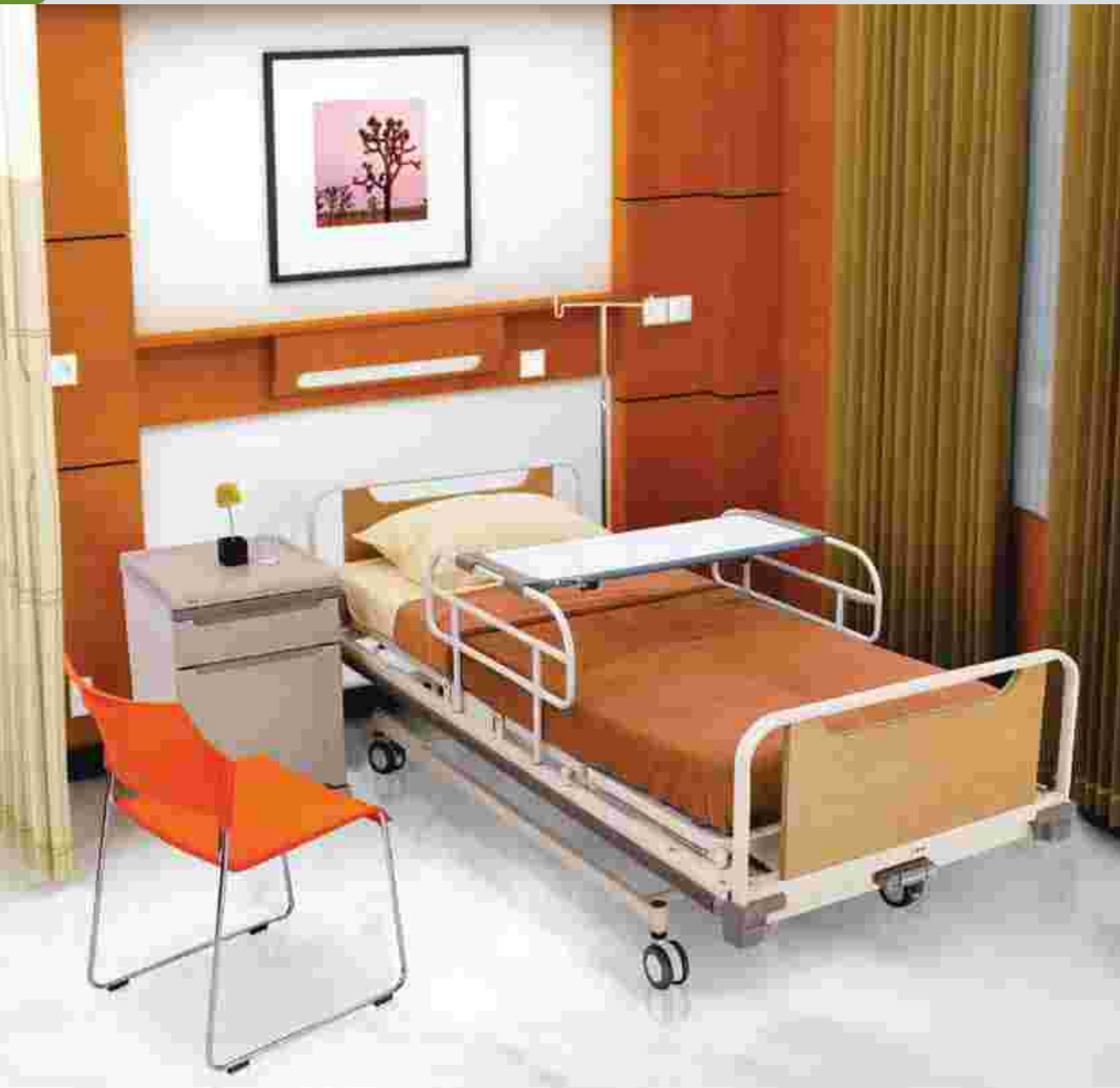

OPERATION SYSTEM

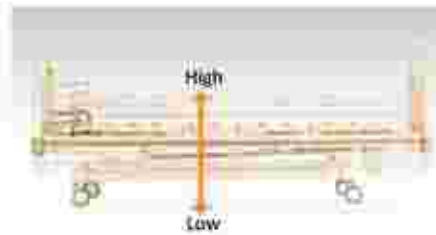

Body support line which consists of three jointly of strong steel panels ergonomically supports the user's body balance evenly.

CB-3011 D ST CB-3011 D JP CB-3011 D DX

OPTION

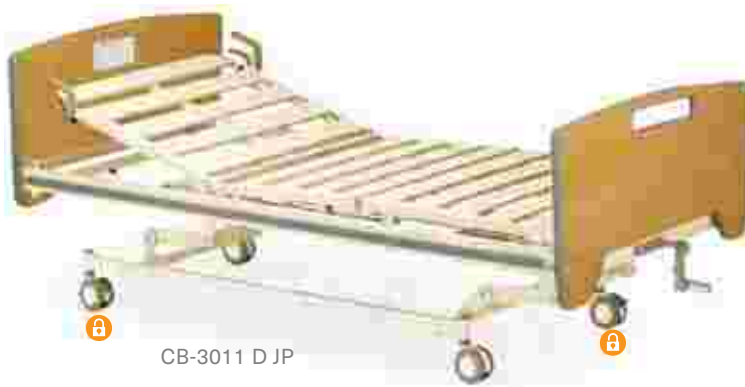

ONE CYLINDER ONE CRANK BED

FEATURES & PROCEDURES



Head/foot board panel dismantle

Head/foot board panel installation

LOCKING OPERATION SYSTEM

An unique eye catching foldable crank is designed to give high-low bed adjustment.



Crank operation system

Back raise adjustment

CASTER OPERATION SYSTEM

Independent lock caster (one at front and one at back of the bed) provides stability and secure parking.



PRODUCT SPECIFICATIONS

Operating System	Adjustable Hi-Lo by crank, adjustable back raise with cylinder gas control
Accessories	Side Rail (CSR-001, CSR-002, CSR-003) & Folding Side Rail (FSR-001)
Lock System	Double Lock System
Weight (kg)	Approx. 90
Frame Finishing	Powder Coating
Frame Color	Ivory
Frame Material	Steel
Dimension (mm)	Bed (W 932, L 2141, H 654-994), H/F Board (W 932)

PRODUCT DIMENSION

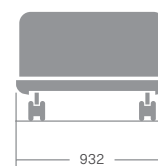
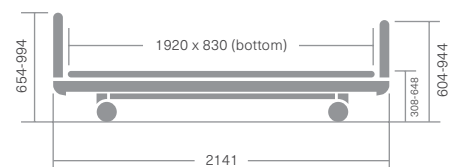



OPERATION SYSTEM

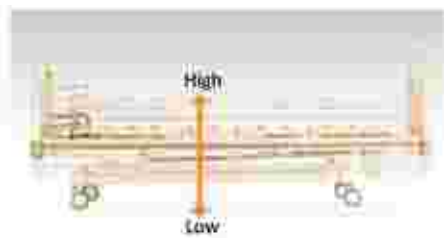
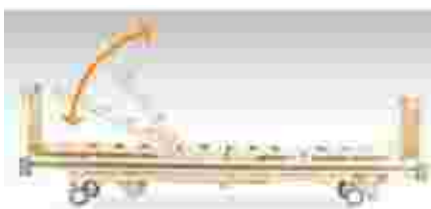

Body support line which consists of three jointly of strong steel panels ergonomically supports the user's body balance evenly.

CB-135 D ST CB-135 D JP CB-535 D ST

OPTION



ONE CYLINDER ONE CRANK BED

FEATURES & PROCEDURES



Head/foot board panel dismantle



Head/foot board panel installation

OPERATION SYSTEM

An unique eye catching foldable crank is designed to give high-low bed adjustment.



Crank operation system

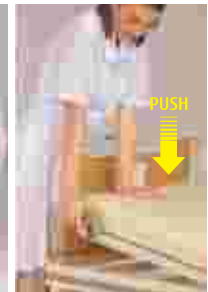

Back raise adjustment

CASTER OPERATION SYSTEM

Independent lock caster (one at front and one at back of the bed) provides stability and secure parking.



PRODUCT SPECIFICATIONS

Operating System	Adjustable Hi-Lo by crank, adjustable back raise with cylinder gas control
Accessories	Side Rail (CSR-001, CSR-002, CSR-003) & Folding Side Rail (FSR-001)
Lock System	Double Lock System
Weight (kg)	Approx. 90
Frame Finishing	Powder Coating
Frame Color	Ivory
Frame Material	Steel
Dimension (mm)	Bed (W 932, L 2141, H 724-969), H/F Board (W 932)

PRODUCT DIMENSION

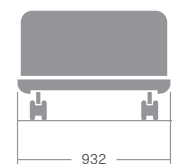
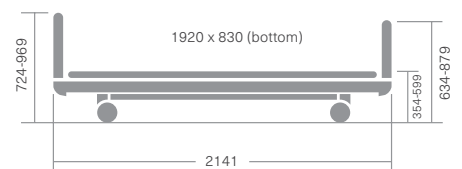



CB-7003 D ST CB-7012 D JP CB-7011 D ST

WIDER BED

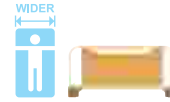

CB-7003 D ST

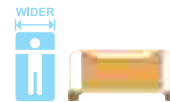

CB-7012 D ST

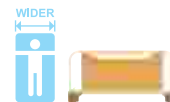

CB-7011 D ST

PRODUCT SPECIFICATIONS

Operating System	Adjustable Hi-Lo by crank, adjustable back raise with cylinder gas control (CB-7012 DST, CB-7011 DST)
Accessories	Side Rail (CSR-001, CSR-002, CSR-003) & Folding Side Rail (FSR-001)
Lock System	Double Lock System
Weight (kg)	Approx. 90
Frame Finishing	Powder Coating
Frame Color	Ivory
Frame Material	Steel
Dimension W x D x H (mm)	Bed (W 1012, L 2141, H 654-994), H/F Board (W 1012)

PRODUCT DIMENSION

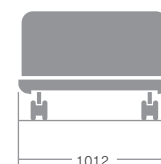
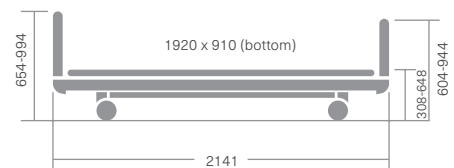

CB-003 STRETCHER

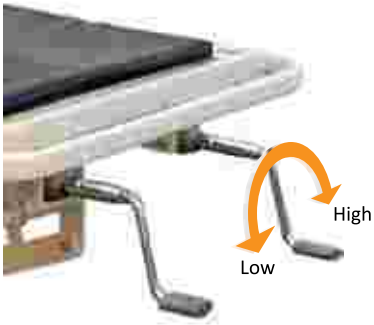

Crank Operational System



Multi purpose Tray



Removable Side Rail



Vinyl-covered Mattress

PRODUCT SPECIFICATIONS

Operating System	Adjustable Hi-Lo back raise by crank
Accessories	Folding Side Rail, Vinyl covered mattress (50 mm in thickness), Cylinder Oxygen Case (Max. 500 L), Irrigator Bar, Multi-purpose Tray
Lock System	Double Lock System
Weight (kg)	Approx. 70
Dimension W x D x H (mm)	750 X 1900 551.5 (Min.)

PRODUCT DIMENSION

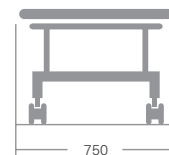
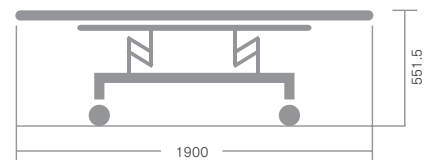



CB-002 GEAR BED FOUR STEPS



CB-002



CB-002 with caster

PRODUCT SPECIFICATIONS

Operating System	Four adjustable back raise by gear, three adjustable Hi-Lo (knock down)
Accessories	Side Rail (CSR-001, CSR-002, CSR-003)
Mattress Material	Urethane & Vinyl Cover
Weight (kg)	Approx. 60
Frame Finishing	Powder Coating
Frame Color	Ivory
Dimension W x D x H (mm)	930 X 2129 X 932

PRODUCT DIMENSION

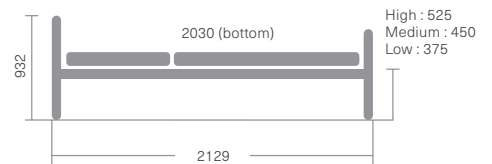

CB-001 STANDARD BED

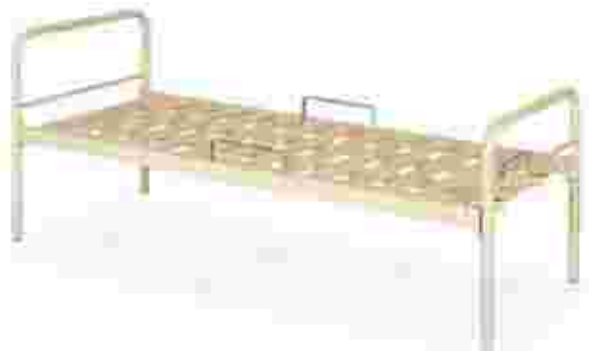

CB-001 D with Caster

PRODUCT SPECIFICATIONS

Operating System	Three adjustable Hi-Lo (knock down)
Accessories	Side Rail (CSR-001, CSR-002, CSR-003)
Main Frame Material	Steel
Head & Foot Frame Material	Steel
Weight (kg)	Approx. 60
Frame Finishing	Powder Coating
Frame Color	Ivory
Dimension W x D x H (mm)	930 X 2129 X 932

PRODUCT DIMENSION

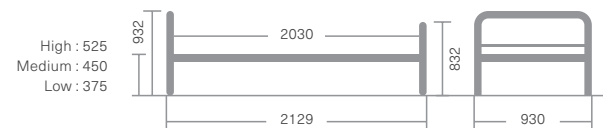

CB-501 WIRE MESH BOTTOM

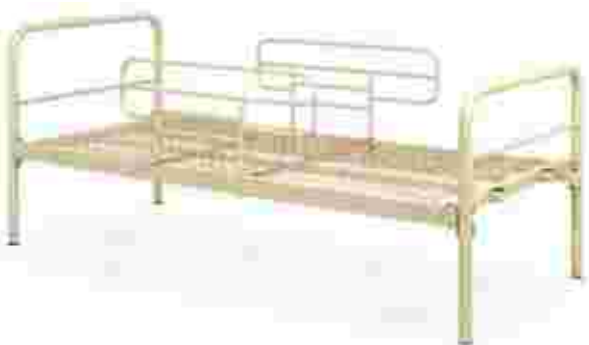

PRODUCT SPECIFICATIONS

Operating System	Three adjustable Hi-Lo (knock down)
Accessories	Side Rail (CSR-001, CSR-002, CSR-003)
Main Frame Material	Steel
Head & Foot Frame Material	Steel
Weight (kg)	Approx. 60
Frame Finishing	Powder Coating
Frame Color	Ivory
Dimension W x D x H (mm)	930 X 2129 X 932

PRODUCT DIMENSION

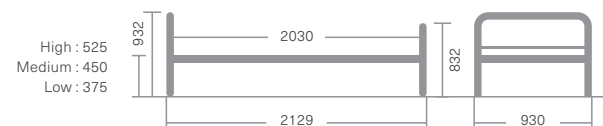



BABY COT

PRODUCT SPECIFICATIONS

Weight (kg)	Approx. 30
Frame Finishing	Powder Coating
Frame Color	Pink & Ivory
Frame Material	Steel

PRODUCT DIMENSION

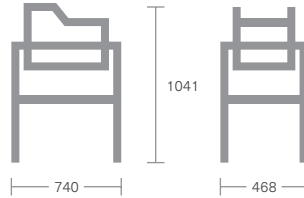

CB-005 Baby Cot (with caster)



CB-005 Baby Cot (without caster)

PRODUCT SPECIFICATIONS

Dimension W x D x H (mm)	650 X 2000 X 700
Main Frame Material	Steel
Frame Finishing	Powder Coating
Frame Color	Ivory

PRODUCT DIMENSION

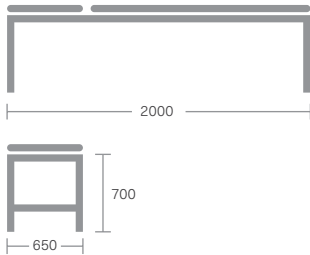

EXAMINATION BED



CB-004 Ex G Examination Gear Bed



CB-004 Ex G Examination Bed (Flat)

PRODUCT RANGE TABLE

Type	Lock			Bottom			H/F Board			Gear Bed	Flat Bed
	2 Lock	4 Lock	Total Lock	Slimeoz	Wim Mesh	Wider	ST	DX	JP		
Electric Operating System											
Ergonomic Bed											
CB-0733 T			✓	✓				✓			
3000 Series											
CB-3300 T ST			✓	✓			✓				
CB-3300 T DX			✓	✓				✓			
CB-3300 T JP			✓	✓					✓		
CB-3300 D ST	✓			✓			✓				
CB-3300 D DX	✓			✓				✓			
CB-3300 D JP	✓			✓					✓		
Manual Operating System of Crotch											
CB-3003 D ST	✓			✓			✓				
CB-3003 D DX	✓			✓				✓			
CB-3003 D JP	✓			✓					✓		
One Cylinder Two Crotch Bed											
CB-3012 D ST	✓			✓			✓				
CB-3012 D DX	✓			✓				✓			
CB-3012 D JP	✓			✓					✓		
CB-3012 D4 ST		✓		✓			✓				
CB-3012 D4 DX		✓		✓				✓			
CB-3012 D4 JP		✓		✓					✓		
One Cylinder One Crotch Bed											
CB-3011 D ST	✓			✓			✓				
CB-3011 D DX	✓			✓				✓			
CB-3011 D JP	✓			✓					✓		
Wider Bed											
CB-7003 D ST	✓					✓	✓				
CB-7012 D ST	✓					✓	✓				
CB-7011 D ST	✓					✓	✓				
135 Bed											
One Cylinder One Crotch Bed											
CB-135 D ST	✓			✓			✓				
CB-135 D JP	✓			✓					✓		
CB-535 D ST	✓				✓		✓				
Gear Bed											
CB-002										✓	
CB-002 D	✓									✓	
Headrest Bed											
CB-001				✓							✓
CB-001 D	✓			✓							✓
CB-501 D					✓						
Transportation/Inclinable											
CB-003			✓	✓							
Examination Bed											
CB-004 Ex G				✓						✓	
CB-004 Ex				✓							
Baby Cot											
CB-005											✓
CB-005 D	✓										✓



ST (MAPLE)

PRODUCT SPECIFICATIONS

Frame Material	Steel
Panel Material	Particle Board laminated with PVC sheet current oak



ST DB (DARK BROWN)

PRODUCT SPECIFICATIONS

Frame Material	Steel
Panel Material	Particle Board laminated with PVC sheet dark brown



ST LG (LIGHT GREY)

PRODUCT SPECIFICATIONS

Frame Material	Steel
Panel Material	Particle Board laminated with PVC sheet light grey



DX

PRODUCT SPECIFICATIONS

Panel Material	PP Plastic laminated with PVC sheet current oak
----------------	---



DX DB (DARK BROWN)

PRODUCT SPECIFICATIONS

Panel Material	PP Plastic laminated with PVC sheet dark brown
----------------	--



DX LG (LIGHT GREY)

PRODUCT SPECIFICATIONS

Panel Material PP Plastic laminated with
PVC sheet light grey



JP

PRODUCT SPECIFICATIONS

Panel Material Particle Board laminated
with PVC sheet current oak



USABILITY TABLE HEAD BOARD & FOOT BOARD (H/F)

H/F Board (Nursing Bed)	ST	ST DB (Dark brown)	ST LG (Light grey)	DX	DX DB (Dark brown)	DX LG (Light grey)	JP
CB-0733 T				✓	✓	✓	
CB-3300 T	✓	✓	✓	✓	✓	✓	
CB-3300 D	✓	✓	✓	✓	✓	✓	✓
CB-3003 D	✓	✓	✓	✓	✓	✓	✓
CB-7003 D	✓	✓	✓				
CB-3012 D	✓	✓	✓	✓	✓	✓	✓
CB-3012 D4	✓	✓	✓	✓	✓	✓	✓
CB-7012 D	✓	✓	✓				
CB-3011 D	✓	✓	✓	✓	✓	✓	✓
CB-7011 D	✓	✓	✓				
CB-135 D	✓	✓	✓				✓
CB-535 D	✓	✓	✓				



MATTRESS

MT-001 S & MT-001 W



Compatibility CB-135 D, CB-535 D, CB-3011 D, CB-7011 D

Dimension W x D x H (mm) 840 X 1920 X 60 (MT-001 S)
920 X 1920 X 60 (MT-001 W)

Material High Density Polyethylene

Cover Oscar

MT-002 S & MT-002 W



Compatibility CB-3300 T, CB-3003 D, CB-3012 D, CB-7003 D, CB-7012 D

Dimension W x D x H (mm) 850 X 1920 X 60 (MT-002 S)
920 X 1920 X 60 (MT-002 W)

Material High Density Polyethylene

Cover Oscar

MT-003 S & MT-003 W

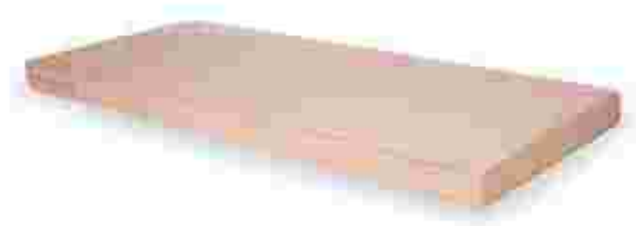

Compatibility CB-0733 T, CB-3300 T, CB-3003 D, CB-3012 D, CB-3011 D, CB-135 D, CB-535 D, CB-501, CB-001, CB-7003 D, CB-7012 D, CB-7011 D

Dimension W x D x H (mm) 860 X 1940 X 150 (MT-003 S)
920 X 1940 X 150 (MT-003 W)

Material Urethane Foam

Cover Fabric

MT-004 S



Compatibility CB-0733 T, CB-3300 T, CB-3003 D, CB-3012 D, CB-3011 D, CB-135 D, CB-535 D

Dimension W x D x H (mm) 830 X 1920 X 125

Material Latex

Cover Fabric

SIDE RAILS

CSR-001



Compatibility	CB-3300 T, CB-3003 D, CB-3012 D, CB-3011 D, CB-135 D, CB-7003 D, CB-7012 D, CB-7011 D, CB-001, CB-002
Dimension W x L (mm)	480 X 920
Frame Material	Steel
Frame Colour	Ivory

CSR-002



Compatibility	CB-3300 T, CB-3003 D, CB-3012 D, CB-3011 D, CB-135 D, CB-7003 D, CB-7012 D, CB-7011 D, CB-001, CB-002
Dimension H x L (mm)	480 X 860
Frame Material	Steel
Frame Colour	Ivory

CSR-003



Compatibility	CB-3300 T, CB-3003 D, CB-3012 D, CB-3011 D, CB-135 D, CB-7003 D, CB-7012 D, CB-7011 D, CB-001, CB-002
Dimension H x L (mm)	475 X 715
Frame Material	Steel
Frame Colour	Ivory

FSR-001 (FOLDING SIDE RAIL)



Compatibility	CB-0733 T, CB-3300 T, CB-3003 D, CB-3012 D, CB-3011 D, CB-135 D, CB-535 D
Dimension H x L (mm)	413 X 1224
Frame Material	Silver Anodize, Powder Coating (lower)
Frame Colour	Ivory



IRRIGATOR BAR & TABLE PANEL

HR-001 (IRRIGATOR BAR)

Dimension H (mm)

Min. 900, max. 1500

Material

Steel with Chrome Finishing



TB-001 (TABLE PANEL)

Compatibility

CB-3300 T, CB-3003 D, CB-3012 D,
CB-3011 D, CB-135 D,
CB-002, CB-001

Dimension W x L (mm)

310 X 880

Material

Particle Board laminated with
white HPL



FS-001 (FOOT STEP)

Dimension D x L x H (mm)

475 X 500 X 500

Material

Steel with Powder Coating

Weight (kg)

approx. 8

Frame Colour

Beige



OTHER EQUIPMENTS

TB-002 (BED SIDE TABLE)



Dimension D x L x H (mm)	360 X 900 X 750-1000
Mobility	Moveable, using Caster (dia. 50mm)
Adjustability	Adjustable Height
Table Top Material	Particle Board laminated with white HPL
Base Construction Material	Steel
Frame Colour	Ivory
Frame Finishing	Powder Coating

CBC-002 (BED SIDE CABINET)



Dimension W x D x H (mm)	445 X 463 X 700
Weight (kg)	14
Mobility	Moveable, using Caster (dia. 40mm)
Material	Plastic (Top Board), Steel (Body)
Finishing	Powder Coating

ACCESSORIES RANGE TABLE

Type	Material	Description	Product Code
Mattress			
MT-001	High Density Polyethylene	840 x 1920 x 60 mm	MT-001 S
MT-001	High Density Polyethylene	920 x 1920 x 60 mm	MT-001 W
MT-002	High Density Polyethylene	850 x 1920 x 60 mm	MT-002 S
MT-002	High Density Polyethylene	920 x 1920 x 60 mm	MT-002 W
MT-003	Urethane Foam	680 x 1940 x 150 mm	MT-003 S
MT-003	Urethane Foam	820 x 1940 x 150 mm	MT-003 W
MT-004	Latex	830 x 1920 x 125 mm	MT-004 S
Irrigator Bar	Steel with chrome finishing	(max.) 900 mm, (trax.) 1500 mm	IR-001
Rise Rail			
CSR-001	Steel	480 x 920 mm	CSR-001
CSR-002	Steel	480 x 860 mm	CSR-002
CSR-003	Steel	475 x 715 mm	CSR-003
FSR-001	Silver Powder, Powder Coating (inner)	470 x 1480 mm	FSR-001
Table Panel	Particle Board Laminated with HPL white		TB-001
Foot Grip	Steel with powder coating finishing	674 x 500 x 500 mm	FS-001
Bed Side Table	Particle Board Laminated with HPL white Steel with powder coating finishing	360 x 900 x 750-1000 mm	TB-002
Bed Side Cabinet	Plastic top sheet, steel body, powder coating finishing	445 x 463 x 700 mm	CBC-002

FABRIC



NEW SCOTLAND (N)

Flammability Complies with BS EN 1021-1: 1994-Part 1 (Cigarette) & California Technical Bulletin No. 117 - 1980 Section E. (Note: Flammability Performance is dependent on the foam used).

SPRINGS (S)

Flammability Complies with BS EN 1021-1: 2006-(Cigarette). Tested in combination with UBM foam 32 kg/m3

DALLAS (D)

Flammability Complies with BS EN 1021-1: 2006-(Cigarette). Tested in combination with UBM foam 32 kg/m3



L1 Blue



L2 Grey



L6 Green



Y1 Blue



Y2 Grey



Yk3 Maroon



D1 Blue



D3 Red



D6 Green



N3 Red



N4 Brown



N5 Cream



Lv1 Blue



Lv3 Red



Lv6 Green



A1 Blue



A3 Red



A4 Brown

PVC



1 Blue PVC Sheet



3 Red PVC Sheet



6 Green PVC Sheet



I1 Blue



I3 Red



I6 Green

OSCAR



O1 Blue



O3 Red



O5 Cream



T1 Blue



T4 Brown



T14 Navy Blue

PLASTIC



White

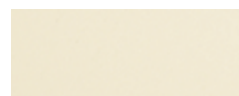

Beige



Light Grey



Orange



Red



Brown



L7 Black



L8 Yellow



L12 Orange



L13 Light Green



LE 1 Blue



LE 2 Grey



LE 3 Maroon



LE6 Green



LE7 Black



D7 Black



S1 Blue



S2 Grey



S6 Green



S9 Pink



W1 Blue



W2 Grey



W3 Maroon



W6 Green



W7 Black



Sd1 Blue



Sd3 Red



Sd6 Green



Sd7 Black



Sd8 Yellow



A5 Cream



Red



Orange



Green



Blue



V1 Blue Vinyl



V3 Red Vinyl



V7 Black Vinyl



Black PVC Sheet



Black Sponge Leather



I8 Yellow



I9 Pink



I12 Orange



I13 Light Green



I14 Light Blue



O6 Green



O7 Black



O10 White



So3 Red



So7 Black



2 Dark Grey



4 Brown



Se5 Beige



Se7 Black

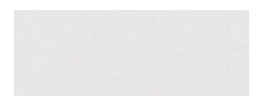

Se10 White



Dark Grey

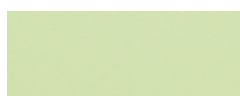

Light Green



Light Blue



Blue



Green



Grey



Yamato NP Red



Yamato NP Black

Industrial Standards of Indonesia and Japanese Industrial Standard. This achievement cannot be separated by the three factors that make Chitose stand out from the rest: stability in quality, comfort, safe and healthy for the user, as well as being aesthetically pleasing. From time to time, the quality of Chitose product has been strictly maintained. It is made possible by the production process; which referred to the integrated system of automation. The implementation of the system results in uniform and consistent shapes and quality for all Chitose products.



ENDURANCE TEST

The testing standard for chairs complies with JIS S 1032-2004 (10.2e)

1ST TEST (FOR SEAT) (JIS S 1203 7.5)		2ND TEST (FOR BACK) (JIS S 1203 7.6)	
Hydraulic Pressure	950N = 96.9 kg	Hydraulic Pressure	330N = 33.7 kg
Pressure Cycles	20 times/min. 3 sec./cycle	Pressure Cycles	20 times/min. 3 sec./cycle
Frequency		Frequency	
• Folding Chair	12.500 times	• Folding Chair	12.500 times
• Swivel Chair	50.000 times	• Swivel Chair	50.000 times
• Non Swivel Chair	50.000 times	• Non Swivel Chair	50.000 times
• Stool Chair	50.000 times		



ROTARY TEST

The testing standard for chairs complies with JIS S 1032-1994 (8.3)

Pressure Weight	105 kg
Rotation Count	4.255 times



IMPACT TEST

The testing standard for chairs complies with JIS S 1032-2004 (10.3a)

Pressure Weight	25 kg
Frequency	10 times
Stroke Height	
• Folding Chair	140 mm
• Swivel Chair	180 mm
• Non Swivel Chair	180 mm
• Stool Chair	180 mm



MOMENTUM TEST

The testing standard for chairs complies with CINT Standard

Load Weight	55 kg
Stroke Height	50 mm (from the bottom of the chair's front feet to the floor)
Impact Count	12.500 times
• Folding Chair	2.000 times
• Non Swivel Chair	3.000 times
• Stool Chair	3.000 times

A	AJ Chair	70	E	Echool	29		KT-01 Cavis 3 & 4	126		
	Aso DS	124		Echool Plus	30		KT-02 Cavis 3 & 4	127		
	Aso SS	125		Echool Art	37		KT-02 Olive 3 & 4	128		
	ATC-01	128		Echool JP	28		KT-03 Kogu	129		
	Ayumi	36		EPO-130	76		Kogu PC	129		
B	Baby Cot	154	EPO-330	75	Kogu PP	129				
	Baby Cot 2 Lock	154	EPO-530	74	Kogu TS	129				
	Benkyo HSD-01	44	ET-170	77	Kumi ED	107				
			ET-171	77	Kumi FD	109				
C	Caesar N/P	51	ET D-500 / ET D-501	79	Kumi MD	108				
	CAL	12	Examination Bed Flat	154	Kumi MT	107				
	Callisto	53	Examination Bed Gear	154	Kumi SD	108				
	Cavis	53	Executive Rack L	118	Kumi Wagon 2D	109				
	CB-001 Standard Bed	153	Executive Rack M	118	Kumi Wagon 3D	109				
	CB-002 Gear Bed Four Steps	152	Executive Rack S	118						
	CB-003 Stretcher	151	F	Fitto FL	82	L	Legno-201	73		
	CB-0733 T	136		Fitto FL-A	82		Legno-203	73		
	CB-135 D ST, D JP	148		Fitto FL-R	82		Leon	94		
	CB-3003 D ST, D JP, D DX	142		Fitto ST	93		Lotus	92		
	CB-3011 D ST, D JP, D DX	146		Fitto SW	81		M	Manabu AH-1	38	
	CB-3012 D ST, D JP, D4 DX	144		Flaptor	101	Manabu AH-2		39		
	CB-3300 D ST, D JP, T DX	140		Flora H	56	Manabu P		31		
	CB-501 Wire Mesh	153		Flora San	57	Manabu P JP		31		
	CB-535 D ST	148		Folding Table FTC-6012	64	Manabu P Plus		32		
	CB-7003 D (Wider Bed)	150		Folding Table FTC-6012 NE	65	Manifold		99		
	CB-7011 D (Wider Bed)	150		Folding Table FTC-6018	65	Maple Rack L		116		
	CB-7012 D (Wider Bed)	150		FS-001 (Foot Step)	160	Maple Rack M		116		
	CBC-002 (Bed Side Cabinet)	161		Fronty	88	Maple Rack S		116		
	CB Chair	71		FTU-6018	106	Mattress Standard & Wider		158-159		
	CK - 810	114		Fuji DS	122	Medix-611	74			
	CK - 1800	114		Fuji SS	123	N	NA, NAN, NBK, NC	80		
	Colour Box 89	44		G	Glory		55	O	Olive A	54
	Colour Box 35 D	44			Grey Rack L		118		Olive A LM	43
	Colour Box 35 S	44			Grey Rack M	118	Olive DX		87	
	Colour Box 35	44			Grey Rack S	118	Olive SC		86	
	Cosmo 541/542	11		H	Hanako S	50	Olive U		54	
Cosmo 941/942	12	Head Board & Foot Board Panel	156-157		P	Porus	72			
Cosmo MNR/MPR	21	Hobby Table T-1010	60			Prince	52			
Cosmo MNR/MPR Plus	21	HTU-6014	106			R	Rack Junior	45		
Cosmo LMPR	23	I	Inexto H-1800 SW		112		Ribbon P	57		
Costa	95		Inexto H-1320 SW/SL	112	S		Sakata N	52		
Cozy	91		Inexto H-1020 SW/SL	112			SAM	56		
Coffee Table R-75	61		Inexto H-720	112			Sankei C-350	83		
Coffee Table T-60	62		Inexto Locker 3D	113		Sankei C-350 C	83			
Coffee Table T-60 Kotatsu	64		Inexto Locker 4D	113		Sankei C-371	93			
Coffee Table T-60 NE	62		Irrigator Bar & Table Panel	160		Sankei C-395	55			
Coffee Table T-60 PL	63		J	Jasmine C-111		91	Shelf 7012	114		
D	Daishogun			13		Jasmine C-211	90	Shelf 7070	115	
	Daishogun MUP			22		Jiro S	51	Shelf 7090	115	
	Daishogun LMUP	22		K		Kasai	94	Shiro 1218	43	
	Daishogun UP	14	Keiko FB		34	Shiro 1224	43			
	Daishogun Plus	14	Keiko JP / Keiko		33	Shiro WS 1218	43			
	Duo-01	78	Keiko Plus		35	Shiro WS 1224	43			
	Duo-02	78								
	Duo-03	88								
	Duo-04	89								
	Duo Junior	45								

	Side Rails	159
	SW	100
	Sylphy	72
T	Table T-1010	60
	T-5512	126
	T-7012	105
	T-7014	104
	T-7014 L	104
	T-7014 R	104
	Table T-7575	61
	Table T-6012 Kotatsu	63
	Taro S	50
	TB-002 (Bed Side Table)	161
	TKG-01	41
	TKG-02	42
	TKM-7012 W	98
	TKM-7014	98
	Trolley TM-01	131
	Trolley TM-02	131
	Trolley TF-01	131
	Trolley TF-02	131
	TU-7014	102
	TU-6012	103
	TU-6012 Low	124
	TU-7575 P	103
U	Uni Desk & Chair	40
V	Vista N/P	95
W	Wagon W-6040	105
	Wagon WKM-6040	102
Y	Yamato AA/NN	10
	Yamato HAA/HNN	10
	Yamato MND/MBD	20
	Yamato MND/MBD Plus	20
	Yamato NP	11
	Yasuka Sliding	15
	Yuki	92
8	81T2	81

CERTIFICATION



Certificate No. ID11/01827



Steel Chair



Office Chair

ABOUT THE COMPANY

Company

PT Chitose Internasional Tbk

Head Office

**Jl. Industri III No. 5 Utama
Cimahi 40533, Indonesia**

Phone

+62 22 603 1900

Fax

+62 22 603 1855

Marketing Office & Distribution Center

**Jl. H. M. S. Mintaredja
Baros Cimahi 40521, Indonesia**

Phone

+62 22 2064 777

E-mail

ask@chitose-indonesia.com

Website

www.chitose-indonesia.com

Year of Establishment

1979

Year of Operation

1981

Employees

Approx. 600 persons

Business Line

Manufacturing

Product Lines

Steel Chair Furnitures & Nursing Bed

Product Categories

- Steel Furniture (Folding Chair, Hotel, Restaurant & Food Court, Office Chair, Meeting Chair)
- Desk & Table
- Rack & Storage
- Lobby Space
- School
- Hospital Space

Production Capacity

- Steel Chair: 1.200.000 units/year
- Nursing Bed: 10.000 units/year

Quality Standard

JIS, SNI, ISO 9001

Plant Area

About 25.200 m²

Building Area

About 17.400 m²





PT Chitose International Tbk.

Factory and Head Office

Jln. Industri III no. 5 Utama

Cimahi 40533, Indonesia

Ph. +62 22 603 1900

Fax. +62 22 603 1855

**Showroom - Marketing Office -
Distribution Center**

Jln. H. M. S. Mintaredja Baros

Cimahi 40521, Indonesia

Ph. +62 22 206 4777

Email. ask@chitose-indonesia.com

Website www.chitose-indonesia.com

 [pt chitose international tbk](https://www.facebook.com/ptchitose)

 [@ptchitose](https://twitter.com/ptchitose)

 [chitoseinternational](https://www.instagram.com/chitoseinternational)